

## **SYSMAC CS/CJ/CP Series**

CS1G/H-CPU□□H  
CS1G/H-CPU□□-EV1  
CS1D-CPU□□HA  
CS1D-CPU□□SA  
CS1D-CPU□□P  
CS1D-CPU□□H  
CS1D-CPU□□S  
CS1W-SCB□□-V1  
CS1W-SCU□□-V1

CJ2H-CPU6□-EIP  
CJ2H-CPU6□  
CJ2M-CPU□□  
CJ1H-CPU□□H-R  
CJ1G/H-CPU□□H  
CJ1G-CPU□□P  
CJ1G-CPU□□  
CJ1M-CPU□□  
CJ1W-SCU□□-V1

CP1H-X□□□□-□  
CP1H-XA□□□□-□  
CP1H-Y□□□□-□  
CP1L-M/L□□□-□  
CP1E-E□□D□-□  
CP1E-N□□D□-□

## **SYSMAC One NSJ Series**

NSJ□-□□□□(B)-G5D  
NSJ□-□□□□(B)-M3D

# **Communications Commands**

# **REFERENCE MANUAL**

# **OMRON**

## **NOTE**

All rights reserved. No part of this publication may be reproduced, stored in a retrieval system, or transmitted, in any form, or by any means, mechanical, electronic, photocopying, recording, or otherwise, without the prior written permission of OMRON.

No patent liability is assumed with respect to the use of the information contained herein. Moreover, because OMRON is constantly striving to improve its high-quality products, the information contained in this manual is subject to change without notice. Every precaution has been taken in the preparation of this manual. Nevertheless, OMRON assumes no responsibility for errors or omissions. Neither is any liability assumed for damages resulting from the use of the information contained in this publication.

## **Trademarks**

- Sysmac and SYSMAC are trademarks or registered trademarks of OMRON Corporation in Japan and other countries for OMRON factory automation products.
- CX-One is a registered trademark for Programming Software made by OMRON Corporation.
- Microsoft, Windows, Excel, Visual Basic, and Microsoft Edge are either registered trademarks or trademarks of Microsoft Corporation in the United States and other countries.
- ODVA, CIP, CompoNet, DeviceNet, and EtherNet/IP are trademarks of ODVA.

Other company names and product names in this document are the trademarks or registered trademarks of their respective companies.

## **Copyrights**

Microsoft product screen shots used with permission from Microsoft.

# **SYSMAC CS/CJ/CP Series**

**CS1G/H-CPU□□H**  
**CS1G/H-CPU□□-EV1**  
**CS1D-CPU□□HA**  
**CS1D-CPU□□SA**  
**CS1D-CPU□□P**  
**CS1D-CPU□□H**  
**CS1D-CPU□□S**  
**CS1W-SCB□□-V1**  
**CS1W-SCU□□-V1**  
**CJ2H-CPU6□-EIP**  
**CJ2H-CPU6□**  
**CJ2M-CPU□□**  
**CJ1H-CPU□□H-R**  
**CJ1G/H-CPU□□H**  
**CJ1G-CPU□□P**  
**CJ1G-CPU□□**  
**CJ1M-CPU□□**  
**CJ1W-SCU□□-V1**  
**CP1H-X□□□□-□**  
**CP1H-XA□□□□-□**  
**CP1H-Y□□□□-□**  
**CP1L-M/L□□□-□**  
**CP1E-E□□D□-□**  
**CP1E-N□□D□-□**

# **SYSMAC One NSJ Series**

**NSJ□-□□□□(B)-G5D**  
**NSJ□-□□□□(B)-M3D**

# **Communications Commands**

## **Reference Manual**

*Revised July 2023*





## **Notice:**

OMRON products are manufactured for use according to proper procedures by a qualified operator and only for the purposes described in this manual.

The following conventions are used to indicate and classify precautions in this manual. Always heed the information provided with them. Failure to heed precautions can result in injury to people or damage to property.

 **DANGER** Indicates an imminently hazardous situation which, if not avoided, will result in death or serious injury. Additionally, there may be severe property damage.

 **WARNING** Indicates a potentially hazardous situation which, if not avoided, could result in death or serious injury. Additionally, there may be severe property damage.

 **Caution** Indicates a potentially hazardous situation which, if not avoided, may result in minor or moderate injury, or property damage.

## **OMRON Product References**

All OMRON products are capitalized in this manual. The word “Unit” is also capitalized when it refers to an OMRON product, regardless of whether or not it appears in the proper name of the product.

The abbreviation “Ch,” which appears in some displays and on some OMRON products, often means “word” and is abbreviated “Wd” in documentation in this sense.

The abbreviation “PLC” means Programmable Controller. “PC” is used, however, in some Programming Device displays to mean Programmable Controller.

## **Visual Aids**

The following headings appear in the left column of the manual to help you locate different types of information.

**Note** Indicates information of particular interest for efficient and convenient operation of the product.

**1,2,3...** 1. Indicates lists of one sort or another, such as procedures, checklists, etc.

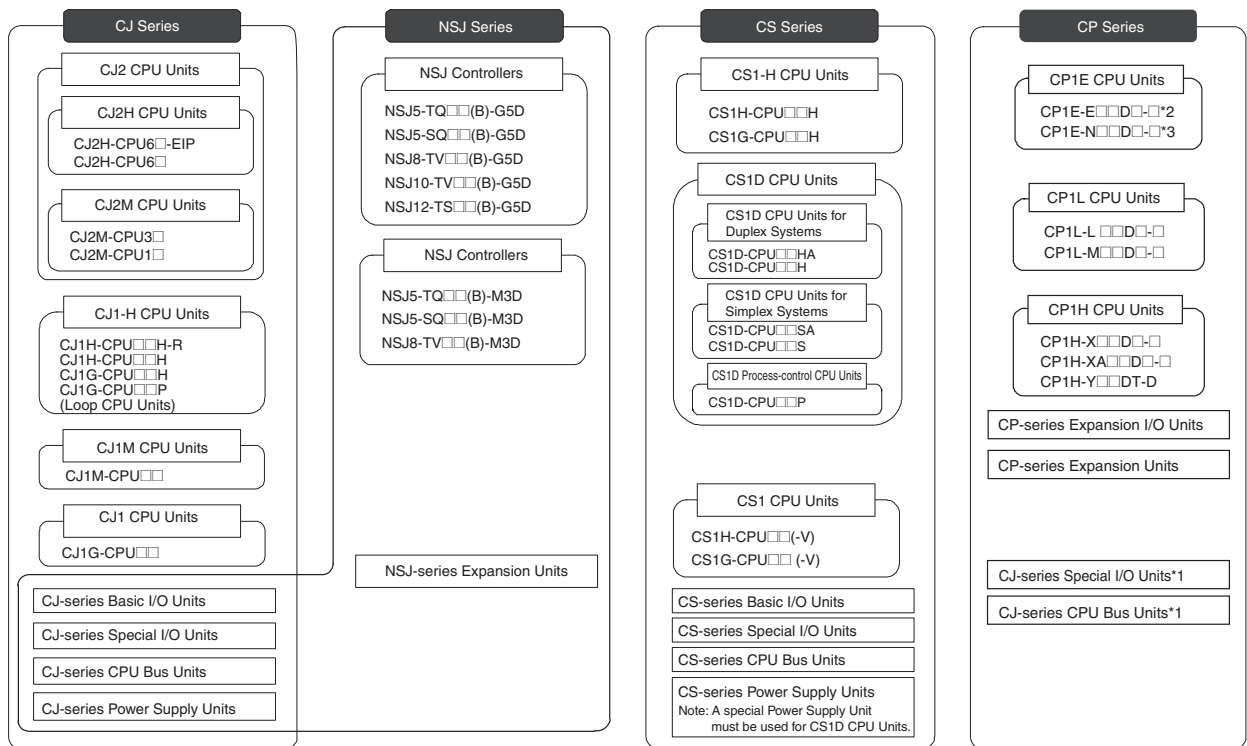

\*1 Can only be used with the CP1H CPU unit.  
 \*2 Indicated as "E-type" in some parts of this manual.  
 \*3 Indicated as "N-type" in some parts of this manual.

# TABLE OF CONTENTS

|   |            |
|---|------------|
| <b>PRECAUTIONS</b> .....  | <b>xv</b>  |
| 1 Intended Audience .....                                       | xvi        |
| 2 General Precautions .....                                     | xvi        |
| 3 Safety Precautions .....                                      | xvi        |
| 4 Operating Environment Precautions .....                       | xviii      |
| 5 Application Precautions .....                                 | xix        |
| <br>  |            |
| <b>SECTION 1</b>  |            |
| <b>Introduction</b> .....                                       | <b>1</b>   |
| 1-1 Overview of Communications Commands .....                   | 2          |
| 1-2 C-mode Commands .....                                       | 2          |
| 1-3 FINS Commands .....   | 4          |
| <br>  |            |
| <b>SECTION 2</b>  |            |
| <b>Overview of C-mode Commands</b> .....                        | <b>7</b>   |
| 2-1 C-mode Commands .....                                       | 8          |
| 2-2 Command/Response Formats .....                              | 9          |
| 2-3 Application Example .....                                   | 14         |
| 2-4 Precautions when Reusing Programs from Earlier Models ..... | 15         |
| <br>  |            |
| <b>SECTION 3</b>  |            |
| <b>Overview of FINS Commands</b> .....                          | <b>27</b>  |
| 3-1 FINS Commands .....   | 28         |
| 3-2 Using FINS Commands .....                                   | 31         |
| 3-3 FINS Command and Response Frames .....                      | 32         |
| 3-4 Settings for Sending FINS Commands .....                    | 35         |
| 3-5 FINS Commands with Host Link Protocol .....                 | 44         |
| 3-6 Serial Gateway Overview .....                               | 67         |
| 3-7 Communications Frames .....                                 | 87         |
| <br>  |            |
| <b>SECTION 4</b>  |            |
| <b>C-mode Commands</b> .....                                    | <b>99</b>  |
| 4-1 C-mode Command List .....                                   | 100        |
| 4-2 End Codes .....   | 103        |
| 4-3 C-mode Command Details .....                                | 105        |
| <br>  |            |
| <b>SECTION 5</b>  |            |
| <b>FINS Commands</b> .....                                      | <b>149</b> |
| 5-1 Command Lists .....   | 150        |
| 5-2 Designating Command Parameters .....                        | 163        |
| 5-3 FINS Commands .....   | 170        |
| <br>  |            |
| <b>Index</b> .....  | <b>239</b> |
| <br>  |            |
| <b>Revision History</b> .....                                   | <b>243</b> |





## About this Manual:

This manual describes the C-series (Host Link) and FINS communications commands used with CS/CJ-series and CP-series Programmable Controllers (PLCs) and NSJ Controllers, and includes the sections described below.

Please read this manual and all related manuals listed in the following table and be sure you understand information provided before attempting to design or implement communications for CS/CJ-series or CP-series Programmable Controllers (PLCs) or NSJ Controllers.

| Name   | Cat. No. | Contents  |
|--|----------|---|
| SYSMAC CS/CJ/CP/NSJ Series<br>CS1G/H-CPU□□-EV1, CS1G/H-CPU□□H,<br>CS1D-CPU□□HA, CS1D-CPU□□SA, CS1D-CPU□□P,<br>CS1D-CPU□□H, CS1D-CPU□□S, CJ1H-CPU□□H-R,<br>CJ1G-CPU□□, CJ1M-CPU□□, CJ1G-CPU□□P,<br>CJ1G/H-CPU□□H, CJ2H-CPU6□-EIP, CJ2H-CPU6□,<br>CJ2M-CPU□□, CS1W-SCU□□-V1, CS1W-SCB□□-V1,<br>CJ1W-SCU□□-V1, CP1H-X□□□□-□, CP1H-XA□□□□-□,<br>CP1H-Y□□□□-□, CP1L-M/L□□□□-□, CP1E-E□□□□-□,<br>CP1E-N□□□□-□, NSJ□-□□□□(B)-G5D,<br>NSJ□-□□□□(B)-M3D<br>Communications Commands Reference Manual | W342     | Describes the communications commands used with CS-series, CJ-series, and CP-series PLCs and NSJ Controllers. (This manual)                         |
| SYSMAC CS/CJ/NSJ Series<br>CS1G/H-CPU□□-EV1, CS1G/H-CPU□□H,<br>CS1D-CPU□□HA, CS1D-CPU□□SA, CS1D-CPU□□P,<br>CS1D-CPU□□H, CS1D-CPU□□S, CJ2H-CPU6□-EIP,<br>CJ2H-CPU6□, CJ2M-CPU□□, CJ1H-CPU□□H-R,<br>CJ1G-CPU□□, CJ1M-CPU□□, CJ1G-CPU□□P, CJ1G/<br>H-CPU□□H, NSJ□-□□□□(B)-G5D, NSJ□-□□□□(B)-M3D<br>Programmable Controllers Instructions Reference Manual   | W474     | Describes the ladder diagram programming instructions supported by CS/CJ-series PLCs and NSJ Controllers.   |
| SYSMAC CS/CJ/NSJ Series<br>CS1G/H-CPU□□-EV1, CS1G/H-CPU□□H,<br>CS1D-CPU□□HA, CS1D-CPU□□SA, CS1D-CPU□□P,<br>CS1D-CPU□□H, CS1D-CPU□□S, CJ1H-CPU□□H-R,<br>CJ1G-CPU□□, CJ1G/H-CPU□□H, CJ1G-CPU□□P,<br>CJ1M-CPU□□, NSJ□-□□□□(B)-G5D,<br>NSJ□-□□□□(B)-M3D<br>Programmable Controllers Programming Manual   | W394     | This manual describes programming and other methods to use the functions of the CS/CJ-series PLCs and NSJ Controllers.                              |
| SYSMAC CS Series<br>CS1D-CPU□□HA CPU Units<br>CS1D-CPU□□SA CPU Units<br>CS1D-CPU□□P CPU Units<br>CS1D-CPU□□H CPU Units<br>CS1D-CPU□□S CPU Units<br>CS1D-DPL01/02D Duplex Unit<br>CS1D-PA/PD□□□ Power Supply Unit<br>Duplex System Operation Manual   | W405     | Provides an outline of and describes the design, installation, maintenance, and other basic operations for a Duplex System based on CS1D CPU Units. |
| SYSMAC CS Series<br>CS1G/H-CPU□□H<br>Programmable Controllers Operation Manual   | W339     | Provides an outlines of and describes the design, installation, maintenance, and other basic operations for the CS-series PLCs.                     |
| SYSMAC CJ Series<br>CJ1H-CPU□□H-R, CJ1G/H-CPU□□H, CJ1G-CPU□□P,<br>CJ1G-CPU□□, CJ1M-CPU□□<br>Programmable Controllers Operation Manual  | W393     | Provides an outlines of and describes the design, installation, maintenance, and other basic operations for the CJ-series PLCs.                     |

| Name   | Cat. No. | Contents  |
|--|----------|---|
| SYSMAC CJ Series CJ2H-CPU6□-EIP, CJ2H-CPU6□, CJ2M-CPU□□ CPU Unit Software User's Manual  | W473     | Describes the following for CJ2 CPU Units: <ul style="list-style-type: none"> <li>• CPU Unit operation</li> <li>• Internal memory</li> <li>• Programming</li> <li>• Settings</li> <li>• Function built into the CPU Unit</li> </ul> Also refer to the <i>Hardware User's Manual (W472)</i>  |
| SYSMAC CJ Series CJ2H-CPU6□-EIP, CJ2H-CPU6□, CJ2M-CPU□□ CPU Unit Hardware User's Manual  | W472     | Describes the following for CJ2 CPU Units: <ul style="list-style-type: none"> <li>• Overview and features</li> <li>• Basic system configuration</li> <li>• Part nomenclature and functions</li> <li>• Mounting and setting procedure</li> <li>• Remedies for errors</li> </ul> Also refer to the <i>Software User's Manual (W473)</i> |
| SYSMAC CS/CJ Series CS1W-EIP21, CJ1W-EIP21, CJ2H-CPU6□-EIP, CJ2M-CPU□□ EtherNet/IP™ Units Operation Manual   | W465     | Describes the built-in EtherNet/IP port and EtherNet/IP Units.<br>Describes basic settings, tag data links, FINS communication, and other functions.  |
| SYSMAC One NSJ Series<br>NSJ5-TQ□□(B)-G5D, NSJ5-SQ□□(B)-G5D, NSJ8-TV□□(B)-G5D, NSJ10-TV□□(B)-G5D, NSJ12-TS□□(B)-G5D, NSJ5-TQ□□(B)-M3D, NSJ5-SQ□□(B)-M3D, NSJ8-TV□□(B)-M3D, NSJW-ETN21, NSJW-CLK21-V1, NSJW-IC101<br>NSJ Controllers Operation Manual | W452     | Provides basic specifications on NSJ Controllers, including an overview, designing, installation, and maintenance.  |
| SYSMAC CP Series<br>CP1H-X40D□-□, CP1H-XA40D□-□, CP1H-Y20DT-D<br>CP1H CPU Unit Operation Manual  | W450     | Provides basic specifications on CP-series CP1H PLCs, including an overview, designing, installation, and maintenance.  |
| SYSMAC CP Series<br>CP1H-X40D□-□<br>CP1H-XA40D□-□<br>CP1H-Y20DT-D<br>CP1L-L14D□-□<br>CP1L-L20D□-□<br>CP1L-M30D□-□<br>CP1L-M40D□-□<br>CP1H CPU Unit Programming Manual  | W451     | Provides information on programming CP-series PLCs.   |
| SYSMAC CP Series<br>CP1L-L10D□-□,<br>CP1L-L14D□-□,<br>CP1L-L20D□-□,<br>CP1L-M30D□-□,<br>CP1L-M40D□-□,<br>CP1L-M60D□-□<br>CP1L CPU Unit Operation Manual  | W462     | Provides basic specifications on CP-series CP1L PLCs, including an overview, designing, installation, and maintenance.  |
| SYSMAC CP Series<br>CP1E-E□□SD□-□<br>CP1E-N□□SD□-□<br>CP1E-E□□D□-□<br>CP1E-N□□D□-□<br>CP1E-NA□□D□-□<br>CP1E CPU Unit Hardware User's Manual  | W479     | Describes the following information for CP1E PLCs. <ul style="list-style-type: none"> <li>• Overview and features</li> <li>• Basic system configuration</li> <li>• Part names and functions</li> <li>• Installation and settings</li> <li>• Troubleshooting</li> </ul>  |

| Name  | Cat. No. | Contents   |
|---|----------|--|
| SYSMAC CP Series<br>CP1E-E□□SD□-□<br>CP1E-N□□S□D□-□<br>CP1E-E□□D□-□<br>CP1E-N□□D□-□<br>CP1E-NA□□D□-□<br>CP1E CPU Unit Software User's Manual        | W480     | Describes the following information for CP1E PLCs. <ul style="list-style-type: none"> <li>• CPU Unit operation</li> <li>• Internal memory</li> <li>• Programming</li> <li>• Settings</li> <li>• CPU Unit built-in functions</li> <li>• Interrupts</li> <li>• High-speed counter inputs</li> <li>• Pulse outputs</li> <li>• Serial communications</li> <li>• Other functions</li> </ul> |
| SYSMAC CP Series<br>CP1E-E□□SD□-□<br>CP1E-N□□S□D□-□<br>CP1E-E□□D□-□<br>CP1E-N□□D□-□<br>CP1E-NA□□D□-□<br>CP1E CPU Unit Instructions Reference Manual | W483     | Describes each programming instruction in detail.  |
| SYSMAC CXONE-AL□□D-V4/CXONE-LT□□□-V4<br>CX-One Version 4.0 FA Integrated Tool Package Setup Manual  | W463     | Provides an overview of the CX-One FA Integrated Tool Package and CX-One installation procedures.  |
| SYSMAC<br>CXONE-AL□□D-V4<br>CS/CJ/CP/NSJ Series<br>CX-Integrator Operation Manual   | W464     | Describes setting and monitoring networks.   |
| SYSMAC<br>CXONE-AL□□D-V4<br>CX-Programmer Operation Manual  | W446     | Describes operating procedures for the CX-Programmer Support Software running on a Windows computer.   |
| SYSMAC CX-Programmer<br>CXONE-AL□□D-V4<br>Operation Manual: Function Blocks/Structured Text   | W447     | Describes specifications and procedures required to use function blocks/structured text.   |
| SYSMAC<br>CXONE-AL□□D-V4<br>CX-Programmer Operation Manual: SFC   | W469     | Describes specifications and procedures required to use SFC programming functions.   |

**Section 1** introduces the C-mode commands and FINS commands, and explains the relationship between them.

**Section 2** provides an overview of C-mode commands.

**Section 3** provides an overview of FINS commands.

**Section 4** provides detailed descriptions of the C-mode commands.

**Section 5** provides detailed descriptions of the FINS commands.

 **WARNING** Failure to read and understand the information provided in this manual may result in personal injury or death, damage to the product, or product failure. Please read each section in its entirety and be sure you understand the information provided in the section and related sections before attempting any of the procedures or operations given.



# ***Terms and Conditions Agreement***

## ***Warranty, Limitations of Liability***

### **Warranties**

- **Exclusive Warranty**

Omron's exclusive warranty is that the Products will be free from defects in materials and workmanship for a period of twelve months from the date of sale by Omron (or such other period expressed in writing by Omron). Omron disclaims all other warranties, express or implied.

- **Limitations**

OMRON MAKES NO WARRANTY OR REPRESENTATION, EXPRESS OR IMPLIED, ABOUT NON-INFRINGEMENT, MERCHANTABILITY OR FITNESS FOR A PARTICULAR PURPOSE OF THE PRODUCTS. BUYER ACKNOWLEDGES THAT IT ALONE HAS DETERMINED THAT THE PRODUCTS WILL SUITABLY MEET THE REQUIREMENTS OF THEIR INTENDED USE.

Omron further disclaims all warranties and responsibility of any type for claims or expenses based on infringement by the Products or otherwise of any intellectual property right.

- **Buyer Remedy**

Omron's sole obligation hereunder shall be, at Omron's election, to (i) replace (in the form originally shipped with Buyer responsible for labor charges for removal or replacement thereof) the non-complying Product, (ii) repair the non-complying Product, or (iii) repay or credit Buyer an amount equal to the purchase price of the non-complying Product; provided that in no event shall Omron be responsible for warranty, repair, indemnity or any other claims or expenses regarding the Products unless Omron's analysis confirms that the Products were properly handled, stored, installed and maintained and not subject to contamination, abuse, misuse or inappropriate modification. Return of any Products by Buyer must be approved in writing by Omron before shipment. Omron Companies shall not be liable for the suitability or unsuitability or the results from the use of Products in combination with any electrical or electronic components, circuits, system assemblies or any other materials or substances or environments. Any advice, recommendations or information given orally or in writing, are not to be construed as an amendment or addition to the above warranty.

See <http://www.omron.com/global/> or contact your Omron representative for published information.

### **Limitation on Liability; Etc**

OMRON COMPANIES SHALL NOT BE LIABLE FOR SPECIAL, INDIRECT, INCIDENTAL, OR CONSEQUENTIAL DAMAGES, LOSS OF PROFITS OR PRODUCTION OR COMMERCIAL LOSS IN ANY WAY CONNECTED WITH THE PRODUCTS, WHETHER SUCH CLAIM IS BASED IN CONTRACT, WARRANTY, NEGLIGENCE OR STRICT LIABILITY.

Further, in no event shall liability of Omron Companies exceed the individual price of the Product on which liability is asserted.

# ***Application Considerations***

## **Suitability of Use**

Omron Companies shall not be responsible for conformity with any standards, codes or regulations which apply to the combination of the Product in the Buyer's application or use of the Product. At Buyer's request, Omron will provide applicable third party certification documents identifying ratings and limitations of use which apply to the Product. This information by itself is not sufficient for a complete determination of the suitability of the Product in combination with the end product, machine, system, or other application or use. Buyer shall be solely responsible for determining appropriateness of the particular Product with respect to Buyer's application, product or system. Buyer shall take application responsibility in all cases.

NEVER USE THE PRODUCT FOR AN APPLICATION INVOLVING SERIOUS RISK TO LIFE OR PROPERTY OR IN LARGE QUANTITIES WITHOUT ENSURING THAT THE SYSTEM AS A WHOLE HAS BEEN DESIGNED TO ADDRESS THE RISKS, AND THAT THE OMRON PRODUCT(S) IS PROPERLY RATED AND INSTALLED FOR THE INTENDED USE WITHIN THE OVERALL EQUIPMENT OR SYSTEM.

## **Programmable Products**

Omron Companies shall not be responsible for the user's programming of a programmable Product, or any consequence thereof.

## ***Disclaimers***

### **Performance Data**

Data presented in Omron Company websites, catalogs and other materials is provided as a guide for the user in determining suitability and does not constitute a warranty. It may represent the result of Omron's test conditions, and the user must correlate it to actual application requirements. Actual performance is subject to the Omron's Warranty and Limitations of Liability.

### **Change in Specifications**

Product specifications and accessories may be changed at any time based on improvements and other reasons. It is our practice to change part numbers when published ratings or features are changed, or when significant construction changes are made. However, some specifications of the Product may be changed without any notice. When in doubt, special part numbers may be assigned to fix or establish key specifications for your application. Please consult with your Omron's representative at any time to confirm actual specifications of purchased Product.

### **Errors and Omissions**

Information presented by Omron Companies has been checked and is believed to be accurate; however, no responsibility is assumed for clerical, typographical or proofreading errors or omissions.

# PRECAUTIONS

This section provides general precautions for using the CS/CJ-series Programmable Controllers (PLCs) and related devices.

**The information contained in this section is important for the safe and reliable application of Programmable Controllers. You must read this section and understand the information contained before attempting to set up or operate a PLC system.**

|   |   |       |
|---|---|-------|
| 1 | Intended Audience . . . . .                 | xvi   |
| 2 | General Precautions . . . . .               | xvi   |
| 3 | Safety Precautions . . . . .                | xvi   |
| 4 | Operating Environment Precautions . . . . . | xviii |
| 5 | Application Precautions . . . . .           | xix   |

## 1 Intended Audience

This manual is intended for the following personnel, who must also have knowledge of electrical systems (an electrical engineer or the equivalent).

- Personnel in charge of installing FA systems.
- Personnel in charge of designing FA systems.
- Personnel in charge of managing FA systems and facilities.

## 2 General Precautions

The user must operate the product according to the performance specifications described in the operation manuals.

Before using the product under conditions which are not described in the manual or applying the product to nuclear control systems, railroad systems, aviation systems, vehicles, combustion systems, medical equipment, amusement machines, safety equipment, and other systems, machines, and equipment that may have a serious influence on lives and property if used improperly, consult your OMRON representative.

Make sure that the ratings and performance characteristics of the product are sufficient for the systems, machines, and equipment, and be sure to provide the systems, machines, and equipment with double safety mechanisms.

This manual provides information for programming and operating the Unit. Be sure to read this manual before attempting to use the Unit and keep this manual close at hand for reference during operation.

 **WARNING** It is extremely important that a PLC and all PLC Units be used for the specified purpose and under the specified conditions, especially in applications that can directly or indirectly affect human life. You must consult with your OMRON representative before applying a PLC System to the above-mentioned applications.

## 3 Safety Precautions

 **WARNING** The CPU Unit refreshes I/O even when the program is stopped (i.e., even in PROGRAM mode). Confirm safety thoroughly in advance before changing the status of any part of memory allocated to I/O Units, Special I/O Units, or CPU Bus Units. Any changes to the data allocated to any Unit may result in unexpected operation of the loads connected to the Unit. Any of the following operation may result in changes to memory status.

- Transferring I/O memory data to the CPU Unit from a Programming Device.
- Changing present values in memory from a Programming Device.
- Force-setting/-resetting bits from a Programming Device.
- Transferring I/O memory files from a Memory Card or EM file memory to the CPU Unit.
- Transferring I/O memory from a host computer or from another PLC on a network.



 **WARNING** Do not attempt to take any Unit apart or touch the inside of any Unit while the power is being supplied. Doing so may result in electric shock.

 **WARNING** Do not touch any of the terminals or terminal blocks while the power is being supplied. Doing so may result in electric shock.

 **WARNING** Do not attempt to disassemble, repair, or modify any Units. Any attempt to do so may result in malfunction, fire, or electric shock.

 **WARNING** Provide safety measures in external circuits (i.e., not in the Programmable Controller), including the following items, to ensure safety in the system if an abnormality occurs due to malfunction of the Programmable Controller or another external factor affecting the operation of the Programmable Controller. “Programmable Controller” indicates the CPU Unit and all other Units and is abbreviated “PLC” in this manual. Not doing so may result in serious accidents.

- Emergency stop circuits, interlock circuits, limit circuits, and similar safety measures must be provided in external control circuits.
- The PLC will turn OFF all outputs when its self-diagnosis function detects any error or when a severe failure alarm (FALS) instruction is executed. Unexpected operation, however, may still occur for errors in the I/O control section, errors in I/O memory, and other errors that cannot be detected by the self-diagnosis function. As a countermeasure for all such errors, external safety measures must be provided to ensure safety in the system.
- The PLC outputs may remain ON or OFF due to deposition or burning of the output relays or destruction of the output transistors. As a countermeasure for such problems, external safety measures must be provided to ensure safety in the system.
- Provide measures in the computer system and programming to ensure safety in the overall system even if communications errors or malfunctions occur in data link communications or remote I/O communications.

 **Caution** Confirm safety before transferring data files stored in the file memory (Memory Card or EM file memory) to the I/O area (CIO) of the CPU Unit using a peripheral tool. Otherwise, the devices connected to the output unit may malfunction regardless of the operation mode of the CPU Unit.

 **Caution** Execute online edit only after confirming that no adverse effects will be caused by extending the cycle time. Otherwise, the input signals may not be readable.

- ⚠ Caution** The CS1-H, CJ1-H, CJ1M, CS1D, or CJ2 CPU Units automatically back up the user program and parameter data to flash memory when these are written to the CPU Unit. I/O memory (including the DM, EM, HR Areas, and the variables set to be held in function blocks), however, is not written to flash memory. The DM, EM, HR Areas, and the variables set to be held in function blocks can be held during power interruptions with a battery. If there is a battery error, the contents of these areas may not be accurate after a power interruption. If the contents of the DM, EM, HR Areas, and the variables set to be held in function blocks are used to control external outputs, prevent inappropriate outputs from being made whenever the Battery Error Flag (A402.04) is ON.
- ⚠ Caution** Confirm safety at the destination node before transferring a program, PLC Setup, I/O tables, I/O memory contents, or parameters to another node or changing contents of any of these items. Transferring or changing data can result in unexpected system operation.
- ⚠ Caution** Tighten the terminal screws on the AC Power Supply Unit to the torque specified in the operation manual. The loose screws may result in burning or malfunction.
- ⚠ Caution** Do not touch the Power Supply Unit when power is being supplied or immediately after the power supply is turned OFF. The Power Supply Unit will be hot and you may be burned.
- ⚠ Caution** Be careful when connecting personal computers or other peripheral devices to a PLC to which is mounted a non-insulated Unit (CS1W-CLK13/53/12/52(-V1) or CS1W-ETN01) connected to an external power supply. A short-circuit will be created if the 24 V side of the external power supply is grounded and the 0 V side of the peripheral device is grounded. When connecting a peripheral device to this type of PLC, either ground the 0 V side of the external power supply or do not ground the external power supply at all.

## 4 Operating Environment Precautions

- ⚠ Caution** Do not operate the control system in the following places:
- Locations subject to direct sunlight.
  - Locations subject to temperatures or humidity outside the range specified in the specifications.
  - Locations subject to condensation as the result of severe changes in temperature.
  - Locations subject to corrosive or flammable gases.
  - Locations subject to dust (especially iron dust) or salts.
  - Locations subject to exposure to water, oil, or chemicals.
  - Locations subject to shock or vibration.
- ⚠ Caution** Take appropriate and sufficient countermeasures when installing systems in the following locations:
- Locations subject to static electricity or other forms of noise.
  - Locations subject to strong electromagnetic fields.

- Locations subject to possible exposure to radioactivity.
- Locations close to power supplies.

 **Caution** The operating environment of the PLC System can have a large effect on the longevity and reliability of the system. Improper operating environments can lead to malfunction, failure, and other unforeseeable problems with the PLC System. Be sure that the operating environment is within the specified conditions at installation and remains within the specified conditions during the life of the system.

## 5 Application Precautions

Observe the following precautions when using the PLC System.

- You must use the CX-Programmer (programming software that runs on Windows) if you need to program more than one task. A Programming Console can be used to program only one cyclic task plus interrupt tasks. A Programming Console can, however, be used to edit multitask programs originally created with the CX-Programmer.

 **WARNING** Always heed these precautions. Failure to abide by the following precautions could lead to serious or possibly fatal injury.

- Always connect to a ground of 100  $\Omega$  or less when installing the Units. Not connecting to a ground of 100  $\Omega$  or less may result in electric shock. A ground of 100  $\Omega$  or less must be installed when shorting the GR and LG terminals on the Power Supply Unit.
- Always turn OFF the power supply to the PLC before attempting any of the following. Not turning OFF the power supply may result in malfunction or electric shock.
  - Mounting or dismounting Power Supply Units, I/O Units, CPU Units, Option Boards, or any other Units.
  - Assembling the Units.
  - Setting DIP switches or rotary switches.
  - Connecting cables or wiring the system.
  - Connecting or disconnecting the connectors.

 **Caution** Failure to abide by the following precautions could lead to faulty operation of the PLC or the system, or could damage the PLC or PLC Units. Always heed these precautions.

- The user program and parameter area data in the CS1-H, CS1D, CJ1-H, CJ1M, and CJ2 CPU Units are backed up in the built-in flash memory. The BKUP indicator will light on the front of the CPU Unit when the backup operation is in progress. Do not turn OFF the power supply to the CPU Unit while the BKUP indicator is lit. The data will not be backed up if power is turned OFF.
- When using a CS-series CS1 CPU Unit for the first time, install the CS1W-BAT01 Battery provided with the Unit and clear all memory areas from a Programming Device before starting to program. (Not required for CS1-H, CJ1, CJ1-H, CJ1M, or CS1D CPU Units.)
- When using the internal clock for a CS-series CS1 CPU Unit, turn ON power after installing the battery and set the clock from a Programming

Device or using the DATE(735) instruction. The clock will not start until the time has been set. (Not required for CS1-H, CJ1, CJ1-H, CJ1M, or CS1D CPU Units.)

- When using a CS1-H, CJ1, CJ1-H, CJ1M, or CS1D CPU Unit, the PLC Setup is set to specify using the mode set on the Programming Console, and a Programming Console is not connected, the CPU Unit will start in RUN mode. This is the default setting in the PLC Setup. A CS1 CPU Unit will start in PROGRAM mode under the same conditions.
- When creating an AUTOEXEC.IOM file from a Programming Device (a Programming Console or the CX-Programmer) to automatically transfer data at startup, set the first write address to D20000 and be sure that the size of data written does not exceed the size of the DM Area. When the data file is read from the Memory Card at startup, data will be written in the CPU Unit starting at D20000 even if another address was set when the AUTOEXEC.IOM file was created. Also, if the DM Area is exceeded (which is possible when the CX-Programmer is used), the remaining data will be written to the EM Area.
- Always turn ON power to the PLC before turning ON power to the control system. If the PLC power supply is turned ON after the control power supply, temporary errors may result in control system signals because the output terminals on DC Output Units and other Units will momentarily turn ON when power is turned ON to the PLC.
- Interlock circuits, limit circuits, and similar safety measures in external circuits (i.e., not in the Programmable Controller) must be provided by the customer.
- Do not turn OFF the power supply to the PLC when reading or writing a Memory Card. Also, do not remove the Memory Card when the BUSY indicator is lit. Doing so may make the Memory Card unusable. To remove a Memory Card, first press the memory card power supply switch and then wait for the BUSY indicator to go out before removing the Memory Card.
- If the I/O Hold Bit is turned ON, the outputs from the PLC will not be turned OFF and will maintain their previous status when the PLC is switched from RUN or MONITOR mode to PROGRAM mode. Make sure that the external loads will not produce dangerous conditions when this occurs. (When operation stops for a fatal error, including those produced with the FALS(007) instruction, all outputs from Output Unit will be turned OFF and only the internal output status will be maintained.)
- The contents of the DM, EM, HR Areas, and the variables set to be held in function blocks in the CPU Unit are backed up by a Battery. If the Battery voltage drops, this data may be lost. Provide countermeasures in the program using the Battery Error Flag (A402.04) to re-initialize data or take other actions if the Battery voltage drops.
- When supplying power at 200 to 240 VAC for CS-series PLCs, always remove the metal jumper from the voltage selector terminals. The product will be destroyed if 200 to 240 VAC is supplied while the metal jumper is attached.
- Always use the power supply voltages specified in the operation manuals. An incorrect voltage may result in malfunction or burning.
- Take appropriate measures to ensure that the specified power with the rated voltage and frequency is supplied. Be particularly careful in places where the power supply is unstable. An incorrect power supply may result in malfunction.

- Install external breakers and take other safety measures against short-circuiting in external wiring. Insufficient safety measures against short-circuiting may result in burning.
- Do not apply voltages to the Input Units in excess of the rated input voltage. Excess voltages may result in burning.
- Do not apply voltages or connect loads to the Output Units in excess of the maximum switching capacity. Excess voltage or loads may result in burning.
- Separate the line ground terminal (LG) from the functional ground terminal (GR) on the Power Supply Unit before performing withstand voltage tests or insulation resistance tests. Not doing so may result in burning.
- Install the Units properly as specified in the operation manuals. Improper installation of the Units may result in malfunction.
- With CS-series PLCs, be sure that all the Unit and Backplane mounting screws are tightened to the torque specified in the relevant manuals. Incorrect tightening torque may result in malfunction.
- Be sure that all the mounting screws, terminal screws, and cable connector screws are tightened to the torque specified in the relevant manuals. Incorrect tightening torque may result in malfunction.
- Always remove any dustproof labels the top of the Units when they are shipped before you turn ON the power supply. If the labels are not removed, heat will accumulate and malfunctions may occur.
- Do not allow wire clippings, shavings, or other foreign material to enter any Unit. Otherwise, Unit burning, failure, or malfunction may occur. Cover the Units or take other suitable countermeasures, especially during wiring work.
- Use crimp terminals for wiring. Do not connect bare stranded wires directly to terminals. Connection of bare stranded wires may result in burning.
- Follow the instructions in this manual to correctly perform wiring.
- Double-check all wiring and switch settings before turning ON the power supply. Incorrect wiring may result in burning.
- Mount terminal blocks and connectors only after checking the mounting location carefully.
- Be sure that the terminal blocks, connectors, Memory Cards, Option Boards, expansion cables, and other items with locking devices are properly locked into place. Improper locking may result in malfunction.
- Check switch settings, the contents of the DM Area, and other preparations before starting operation. Starting operation without the proper settings or data may result in an unexpected operation.
- Check the user program for proper execution before actually running it on the Unit. Not checking the program may result in an unexpected operation.
- After replacing the CPU Unit, a Special I/O Unit, or a CPU Bus Unit, make sure that the required data for the DM Area, Holding Area, and other memory areas has been transferred to the new Unit before restarting operation.
- Confirm that no adverse effect will occur in the system before attempting any of the following. Not doing so may result in an unexpected operation.
  - Changing the operating mode of the PLC (including the setting of the startup operating mode).

- Force-setting/force-resetting any bit in memory.
- Changing the present value of any word or any set value in memory.
- Do not pull on the cables or bend the cables beyond their natural limit. Doing either of these may break the cables.
- Do not place objects on top of the cables or other wiring lines. Doing so may break the cables.
- Do not use commercially available RS-232C personal computer cables. Always use the special cables listed in this manual or make cables according to manual specifications. Using commercially available cables may damage the external devices or CPU Unit.
- Never connect pin 6 (5-V power supply) on the RS-232C port on the CPU Unit to any device other than an NT-AL001 or CJ1W-CIF11 Adapter. The external device or the CPU Unit may be damaged.
- Before touching a Unit, be sure to first touch a grounded metallic object in order to discharge any static built-up. Not doing so may result in malfunction or damage.
- Do not short the battery terminals or charge, disassemble, heat, or incinerate the battery. Do not subject the battery to strong shocks. Doing any of these may result in leakage, rupture, heat generation, or ignition of the battery. Dispose of any battery that has been dropped on the floor or otherwise subjected to excessive shock. Batteries that have been subjected to shock may leak if they are used.
- UL standards required that batteries be replaced only by experienced technicians. Do not allow unqualified persons to replace batteries.
- Dispose of the product and batteries according to local ordinances as they apply. Have qualified specialists properly dispose of used batteries as industrial waste.



「廢電池請回收」

- With a CJ-series PLC, the sliders on the tops and bottoms of the Power Supply Unit, CPU Unit, I/O Units, Special I/O Units, and CPU Bus Units must be completely locked (until they click into place). The Unit may not operate properly if the sliders are not locked in place.
- Unexpected operation may result if inappropriate data link tables or parameters are set. Even if appropriate data link tables and parameters have been set, confirm that the controlled system will not be adversely affected before starting or stopping data links.
- All CPU Bus Units will be restarted when routing tables are transferred from a Programming Device to the CPU Unit. Restarting these Units is required to read and enable the new routing tables. Confirm that the system will not be adversely affected before transferring the routing tables.

# SECTION 1

## Introduction

This section introduces the C-mode commands and FINS commands, and explains the relationship between them.

|     |   |   |
|-----|---|---|
| 1-1 | Overview of Communications Commands . . . . . | 2 |
| 1-2 | C-mode Commands . . . . .                     | 2 |
| 1-3 | FINS Commands . . . . .                       | 4 |

# 1-1 Overview of Communications Commands

## Communications Commands Addressed to CS/CJ/CP/NSJ-series Units

A CS/CJ/CP-series CPU Unit or NSJ Controller can receive the following communications commands.

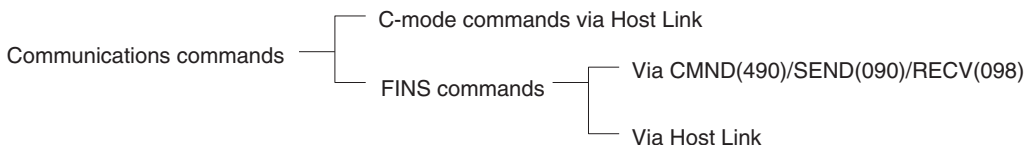

### C-mode Commands

C-mode commands are specialized Host Link communications commands. They are issued by a host computer and sent to a CPU Unit. The devices that can be connected for serial communications are the CPU Unit, a Serial Communications Unit, and a Serial Communications Board.

### FINS Commands

FINS commands are message service communications commands. They do not depend on a particular transmission path. They can be used for communications on various networks (Controller Link, Ethernet, etc.) and for serial communications (Host Link). They can be issued from a CPU Unit, Special I/O Unit, or host computer, and they can also be sent to any of these. The specific commands that can be sent depend on the destination.

This manual explains commands sent to CS/CJ/CP-series CPU Units and NSJ Controllers, when the commands are issued from a CPU Unit or a host computer connected by Host Link.

**Note** When the source of the commands is a CPU Unit, the FINS commands are sent by means of CMND(490)/SEND(090)/RECV(098). When the source is a host computer, the FINS commands are issued using Host Link protocol.

## 1-2 C-mode Commands

The following table lists the C-mode (Host Link) commands. For details, refer to SECTION 4 C-mode Commands.

| Type               | Header code | Name                      | Function  |
|--------------------|-------------|---------------------------|---|
| I/O memory reading | RR          | CIO AREA READ             | Reads the specified number of words beginning with the designated CIO word.                         |
|                    | RL          | LR AREA READ              | Reads the specified number of words beginning with the designated LR word.                          |
|                    | RH          | HR AREA READ              | Reads the specified number of words beginning with the designated HR word.                          |
|                    | RC          | TIMER/COUNTER PV READ     | Reads the specified number of words of the timer/counter PV beginning with the designated word.     |
|                    | RG          | TIMER/COUNTER STATUS READ | Reads the specified number of words of the timer/counter status beginning with the designated word. |
|                    | RD          | DM AREA READ              | Reads the specified number of words beginning with the designated DM word.                          |
|                    | RJ          | AR AREA READ              | Reads the specified number of words beginning with the designated AR word.                          |
|                    | RE          | EM AREA READ              | Reads the specified number of words beginning with the designated EM word.                          |



| Type                      | Header code | Name                      | Function   |
|---------------------------|-------------|---------------------------|--|
| I/O memory writing        | WR          | CIO AREA WRITE            | Writes the specified data in word units beginning with the designated CIO word.  |
|                           | WL          | LR AREA WRITE             | Writes the specified data in word units beginning with the designated LR word.   |
|                           | WH          | HR AREA WRITE             | Writes the specified data in word units beginning with the designated HR word.   |
|                           | WC          | TIMER/COUNTER PV WRITE    | Writes the specified timer/counter PV data in word units beginning with the designated word.   |
|                           | WD          | DM AREA WRITE             | Writes the specified data in word units beginning with the designated DM word.   |
|                           | WJ          | AR AREA WRITE             | Writes the specified data in word units beginning with the designated AR word.   |
|                           | WE          | EM AREA WRITE             | Writes the specified data in word units beginning with the designated EM word.   |
| Timer/counter SV reading  | R#          | TIMER/COUNTER SV READ 1   | Reads in four digits BCD the constant SV that is written as an operand of the designated timer/counter instruction.  |
|                           | R\$         | TIMER/COUNTER SV READ 2   | Finds the specified timer/counter instruction, beginning with the designated program address, and reads the constant SV in four digits or the word in which the SV is stored.  |
|                           | R%          | TIMER/COUNTER SV READ 3   | Finds the specified timer/counter instruction, beginning with the designated program address, and reads the constant SV in four digits (BCD) or the word in which the SV is stored.  |
| Timer/counter SV changing | W#          | TIMER/COUNTER SV CHANGE 1 | Changes the SV of the specified timer/counter instruction to a new constant SV.  |
|                           | W\$         | TIMER/COUNTER SV CHANGE 2 | Finds the specified timer/counter instruction, beginning with the designated program address in the user program, and changes the constant SV in four digits (BCD) or the word in which the SV is stored to a new constant SV or storage word. |
|                           | W%          | TIMER/COUNTER SV CHANGE 3 | Finds the specified timer/counter instruction, beginning with the designated program address in the user program, and changes the constant SV in four digits (BCD) or the word in which the SV is stored to a new constant SV or storage word. |
| CPU Unit status           | MS          | STATUS READ               | Reads the CPU Unit's operating conditions (operating mode, forced set/reset status, and fatal errors).   |
|                           | SC          | STATUS CHANGE             | Changes the CPU Unit's operating mode.   |
|                           | MF          | ERROR READ                | Reads the CPU Unit's error information (i.e., all fatal or non-fatal errors currently in effect).  |
| Forced set/reset          | KS          | FORCED SET                | Forcibly sets one designated bit.  |
|                           | KR          | FORCED RESET              | Forcibly resets one designated bit.  |
|                           | FK          | MULTIPLE FORCED SET/RESET | Forcibly sets/resets/cancels multiple designated bits.   |
|                           | KC          | FORCED SET/RESET CANCEL   | Cancels all forced set/reset status.   |
| PLC model code reading    | MM          | PLC MODEL READ            | Reads the model code of the CPU Unit.  |
| Testing                   | TS          | TEST                      | Returns, just as it is, a single block that was sent from the host computer.   |
| Program area accessing    | RP          | PROGRAM READ              | Reads, in one batch, the contents of the CPU Unit's user program at the machine language (object) level.   |
|                           | WP          | PROGRAM WRITE             | Writes into the CPU Unit's user program area the machine language (object) sent from the host computer.  |

| Type                                     | Header code | Name                              | Function   |
|--|-------------|-----------------------------------|--|
| I/O table creation                       | MI          | I/O TABLE CREATE                  | Creates an I/O table with the contents of the actual I/O configuration.                              |
| I/O memory area registration and reading | QQMR        | REGISTER I/O MEMORY               | Registers the I/O memory words or bits that are to be read.  |
|  | QQIR        | READ I/O MEMORY                   | Reads the registered I/O memory words/bits all at once.  |
| Host Link communications processing      | XZ          | ABORT (command only)              | Aborts the operation being performed by a Host Link command, and then returns to the initial status. |
|  | **          | INITIALIZE (command only)         | Initializes the transfer control procedures for all Host Link Units.                                 |
|  | IC          | Undefined command (response only) | This is the response when the command header code cannot be decoded.                                 |

### 1-3 FINS Commands

The following table lists the FINS commands. For details, refer to SECTION 5 FINS Commands.

| Type                          | Command code |    | Name                                    | Function   |
|-------------------------------|--------------|----|---|--|
|                               | MR           | SR |   |  |
| I/O memory area access        | 01           | 01 | MEMORY AREA READ                        | Reads the contents of consecutive I/O memory area words.                             |
|                               | 01           | 02 | MEMORY AREA WRITE (See note.)           | Writes the contents of consecutive I/O memory area words.                            |
|                               | 01           | 03 | MEMORY AREA FILL (See note.)            | Writes the same data to the specified range of I/O memory area words.                |
|                               | 01           | 04 | MULTIPLE MEMORY AREA READ               | Reads the contents of specified non-consecutive I/O memory area words.               |
|                               | 01           | 05 | MEMORY AREA TRANSFER (See note.)        | Copies the contents of consecutive I/O memory area words to another I/O memory area. |
| Parameter area access         | 02           | 01 | PARAMETER AREA READ                     | Reads the contents of consecutive parameter area words.                              |
|                               | 02           | 02 | PARAMETER AREA WRITE (See note.)        | Writes the contents of consecutive parameter area words.                             |
|                               | 02           | 03 | PARAMETER AREA FILL (CLEAR) (See note.) | Clears the specified range of parameter area words.                                  |
| Program area access           | 03           | 06 | PROGRAM AREA READ                       | Reads the UM (User Memory) area.   |
|                               | 03           | 07 | PROGRAM AREA WRITE (See note.)          | Writes to the UM (User Memory) area.   |
|                               | 03           | 08 | PROGRAM AREA CLEAR (See note.)          | Clears a specified range of the UM (User Memory) area.                               |
| Operating mode changes        | 04           | 01 | RUN (See note.)                         | Changes the CPU Unit's operating mode to RUN or MONITOR.                             |
|                               | 04           | 02 | STOP (See note.)                        | Changes the CPU Unit's operating mode to PROGRAM.                                    |
| Machine configuration reading | 05           | 01 | CPU UNIT DATA READ                      | Reads CPU Unit data.   |
|                               | 05           | 02 | CONNECTION DATA READ                    | Reads the model numbers of the device corresponding to addresses.                    |
| Status reading                | 06           | 01 | CPU UNIT STATUS READ                    | Reads the status of the CPU Unit.  |
|                               | 06           | 20 | CYCLE TIME READ                         | Reads the maximum, minimum, and average cycle time.                                  |
| Time data access              | 07           | 01 | CLOCK READ                              | Reads the present year, month, date, minute, second, and day of the week.            |
|                               | 07           | 02 | CLOCK WRITE (See note.)                 | Changes the present year, month, date, minute, second, or day of the week.           |

| Type                  | Command code |    | Name  | Function   |
|-----------------------|--------------|----|---|--|
|                       | MR           | SR |   |  |
| Message display       | 09           | 20 | MESSAGE READ/CLEAR                                  | Reads and clears messages, and reads FAL/FALS messages.  |
| Access rights         | 0C           | 01 | ACCESS RIGHT ACQUIRE (See note.)                    | Acquires the access right as long as no other device holds it.   |
|                       | 0C           | 02 | ACCESS RIGHT FORCED ACQUIRE                         | Acquires the access right even if another device already holds it.   |
|                       | 0C           | 03 | ACCESS RIGHT RELEASE                                | Releases the access right that has been acquire.   |
| Error log             | 21           | 01 | ERROR CLEAR (See note.)                             | Clears errors or error messages.   |
|                       | 21           | 02 | ERROR LOG READ                                      | Reads the error log.   |
|                       | 21           | 03 | ERROR LOG CLEAR (See note.)                         | Clears all error log records.  |
| FINS write access log | 21           | 40 | FINS WRITE ACCESS LOG READ                          | The CPU Unit automatically keeps a log of any access for FINS write commands. This command reads this log. |
|                       | 21           | 41 | FINS WRITE ACCESS LOG CLEAR (See note.)             | Clears the FINS write access log.  |
| File memory           | 22           | 01 | FILE NAME READ                                      | Reads file device data.  |
|                       | 22           | 02 | SINGLE FILE READ                                    | Reads a specified length of file data from a specified position within a single file.                      |
|                       | 22           | 03 | SINGLE FILE WRITE (See note.)                       | Writes a specified length of file data from a specified position within a single file.                     |
|                       | 22           | 04 | FILE MEMORY FORMAT (See note.)                      | Formats (initializes) the file device.   |
|                       | 22           | 05 | FILE DELETE (See note.)                             | Deletes specified files stored in the file device.   |
|                       | 22           | 07 | FILE COPY (See note.)                               | Copies files from one file device to another file device in the same system.                               |
|                       | 22           | 08 | FILE NAME CHANGE (See note.)                        | Changes a file name.   |
|                       | 22           | 0A | MEMORY AREA-FILE TRANSFER (See note.)               | Transfers or compares data between the I/O memory area and the file device.                                |
|                       | 22           | 0B | PARAMETER AREA-FILE TRANSFER (See note.)            | Transfers or compares data between the parameter area and the file device.                                 |
|                       | 22           | 0C | PROGRAM AREA-FILE TRANSFER (See note.)              | Transfers or compares data between the UM (User Memory) area and the file device.                          |
|                       | 22           | 15 | DIRECTORY CREATE/DELETE (See note.)                 | Creates or deletes a directory.  |
|                       | 22           | 20 | MEMORY CASSETTE TRANSFER (CP1H/CP1L CPU Units only) | Transfers and verifies data between a Memory Cassette and the CPU Unit.                                    |
| Debugging             | 23           | 01 | FORCED SET/RESET (See note.)                        | Force-sets or force-resets bits, or releases force-set status.   |
|                       | 23           | 02 | FORCED SET/RESET CANCEL (See note.)                 | Cancel all bits that have been force-set or force-reset.   |

**Note** These commands will not be accepted and an end code of 2102 hex (cannot write due to protection) will be returned if the *Write Protection from FINS Commands Sent to CPU Units via Networks* option is selected in the PLC Setup for CS1-H CPU Units, CJ1-H CPU Units, CJ1M CPU Units, CS1D CPU Units (for Single CPU Systems) with unit version 2.0 or later, CP-series CPU Units, or NSJ Controllers.



## SECTION 2 Overview of C-mode Commands

This section provides an overview of C-mode (Host Link) commands.

|       |  |    |
|-------|--|----|
| 2-1   | C-mode Commands . . . . .  | 8  |
| 2-2   | Command/Response Formats . . . . .                                       | 9  |
| 2-3   | Application Example. . . . .   | 14 |
| 2-4   | Precautions when Reusing Programs from Earlier Models . . . . .          | 15 |
| 2-4-1 | C-series Host Link Units with 1:N Host Link Format<br>Selected . . . . . | 15 |
| 2-4-2 | C-series Host Link Units with 1:1 Host Link Format<br>Selected . . . . . | 20 |
| 2-4-3 | C-mode Command Support . . . . .   | 22 |

## 2-1 C-mode Commands

C-mode (Host Link) commands form a command/response system for serial communications (Host Link Mode) to perform various control operations between a CPU Unit and a host computer directly connected to it. These operations include reading from and writing to I/O memory, changing operating modes, executing forced set and forced reset operations, and so on.

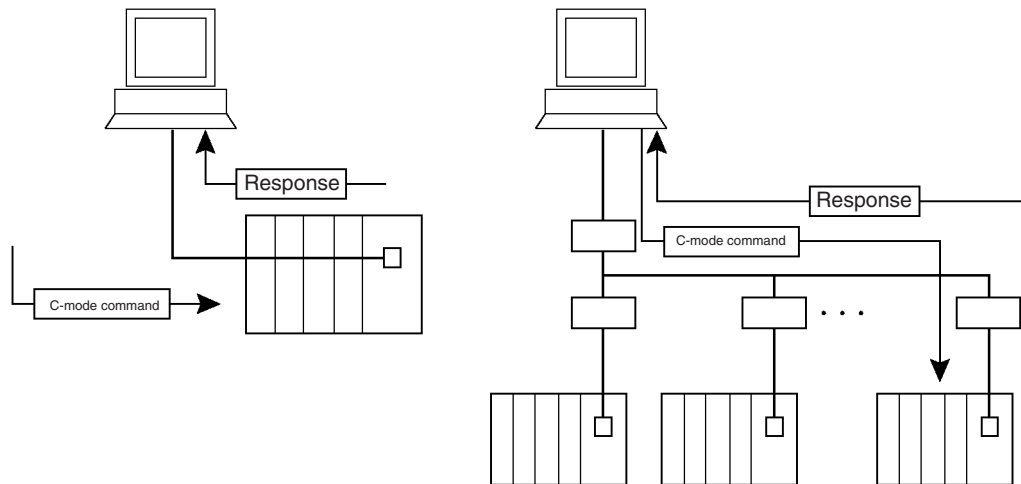

- Note**
1. There are two Host Link formats: the 1:N Host Link (with  $N \geq 1$ ) and the 1:1 Host Link.
    - The 1:1 Host Link is the earlier Host Link format supported by C-series PLCs, such as the C200H, C1000H, and C2000H.
    - The built-in peripheral and RS-232C ports of CS/CJ-series CPU Units, built-in serial ports of N-type CP1E CPU Units, serial port C on NSJ Controllers, and serial ports 1 and 2 on the Option Board for CP-series CPU Units support only the 1:N Host Link format. When a Serial Communications Board or Unit (version 1.2 or later) is being used, a 1:1 Host Link program created for a C-series PLC (C200H/C1000H/C2000H) can be reused by selecting the Host Link 1:1 format.

In this manual, the term “Host Link” generally indicates the 1:N Host Link.

2. Unlike FINS commands, C-mode commands can only be addressed to a CPU Unit, and they cannot be used for message service outside of the local network. They cannot be used for functions such as file operations.

C-mode (Host Link) commands can be sent from a host computer connected to a CS/CJ-series Host Link Unit. Up to 32 PLCs (Host Link Units) can be connected to a single host computer. For identification, each Host Link Unit is assigned a unit number from 0 to 31.

The length of a single unit of a command or response exchange is called a “frame.” A single frame contains a maximum of 131 characters of data. Characters are sent and received as ASCII.

- Note** For a CS/CJ-series PLC, a “Host Link Unit” can be the CPU Unit, a Serial Communications Unit, or a Serial Communications Board.

A maximum of 30 words of data can be transferred for the first command frame and a maximum of 31 words of data can be transferred for other command frames when reading or writing word data in I/O memory. When reading/writing more than 30 words of data, the data transfer will be processed in multiple transmissions, with 30 words in the first and up to 31 words in each of

the following transmissions until the number of words set in the command has been processed.

The frame formats for Host Link commands sent from a host computer and responses returned by the PLC receiving the commands are explained in the following section.

## 2-2 Command/Response Formats

**Single-frame Commands** If a command is not more than 131 characters long, communications can be completed by sending a single command frame. This is called a “single-frame command.”

### Command Frame Format

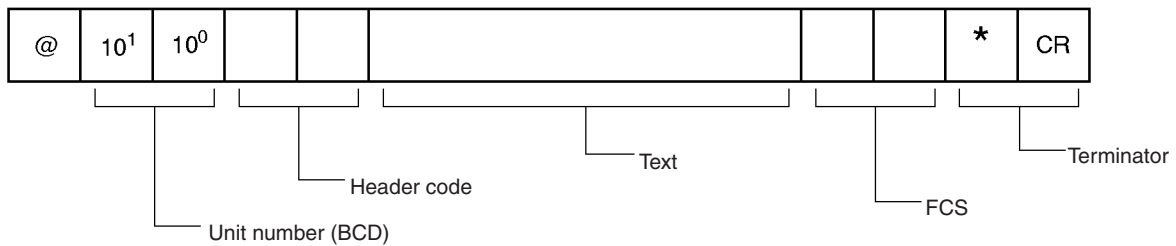

- **@**: Must be attached at the beginning of the command.
- **Unit number**: Set in BCD from 0 to 31 for each Host Link Unit.
- **Header code**: Specified in two characters.
- **Text**: Set parameters corresponding to command code.
- **FCS**: Calculate 2-character FCS (frame check sequence) at host computer. For details on calculating FCS, refer to *FCS Calculations* later in this section.
- **Terminator**: Set “\*” and CR (CHR\$(13)) as two characters to indicate the end of the command.

**Single-frame Response** If a response is not more than 131 characters long, the communications can be completed by returning one response frame. This is called a “single-frame response.”

### Response Frame Format

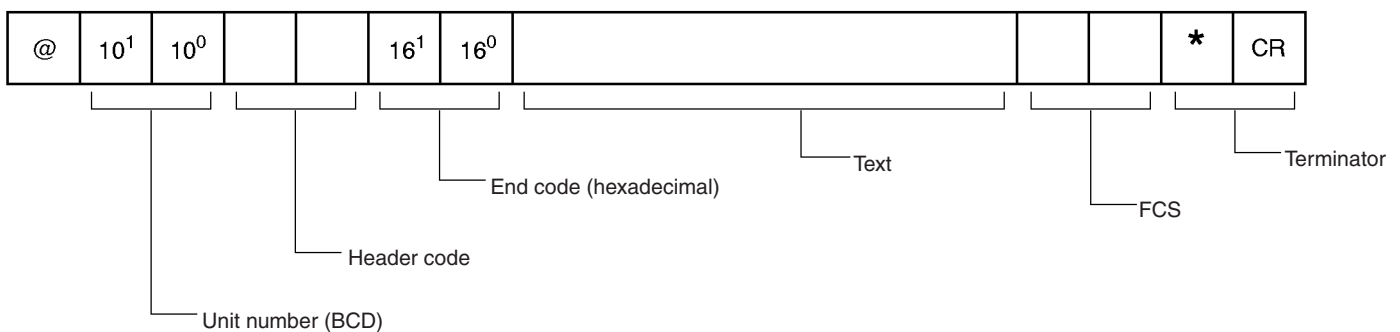

- **@**: Must be attached at the beginning of the response.
- **Unit number**: Set in BCD from 0 to 31 for each Host Link Unit.
- **Header code**: The command code that was received is returned.
- **End code**: The results (error status, etc.) of command execution is returned.
- **Text**: Returned only if there is read data.

- FCS: The 2-character FCS (frame check sequence) is returned.
- Terminator: Two characters indicating the end of the command, "\*" and CR (CHR\$(13)), are returned.

**Error Response Formant**

If a reception error or an error in executing the command occurs, a response is returned with no text.

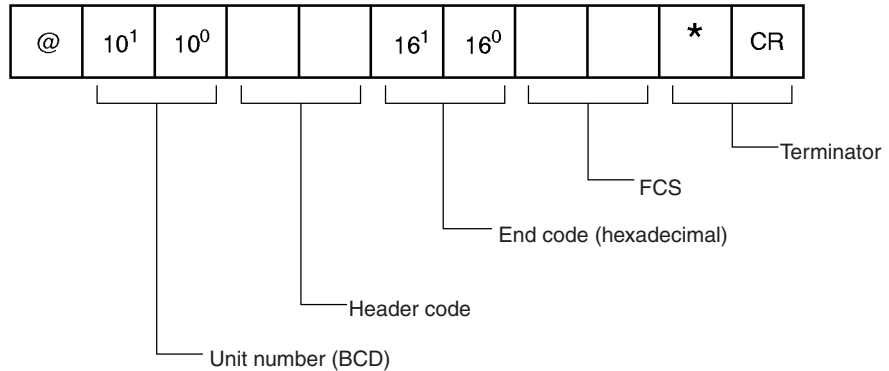

**Partitioned Commands**

If a command is longer than 131 characters, the command’s text is partitioned by sending a delimiter [CR code, CHR\$(13)] instead of a terminator at the end of each command frame until the last one. A terminator is sent at the end of the last frame. The procedure is given below for three command frames.

**Note** When sending command frames for writing (WR, WL, WC, WD, etc.), be careful not to partition into separate frames data that is to be written into the same word.

- 1,2,3...**
1. From the host computer, attach a delimiter (CR) at the end of command frame 1 and send the frame.
  2. When the PLC receives this delimiter (CR), it will return only a delimiter (CR) to the host computer.
  3. From the host computer, attach a delimiter (CR) at the end of command frame 2 and send the frame.
  4. When the PLC receives this delimiter (CR), it will return only a delimiter (CR) to the host computer.
  5. From the host computer, attach a terminator (\*CR) at the end of command frame 3 and send the frame.
  6. When the PLC receives this terminator (\*CR), it will return the response format with a terminator (\*CR) attached to the end.



The following diagram shows the command format when there are more than 131 characters.

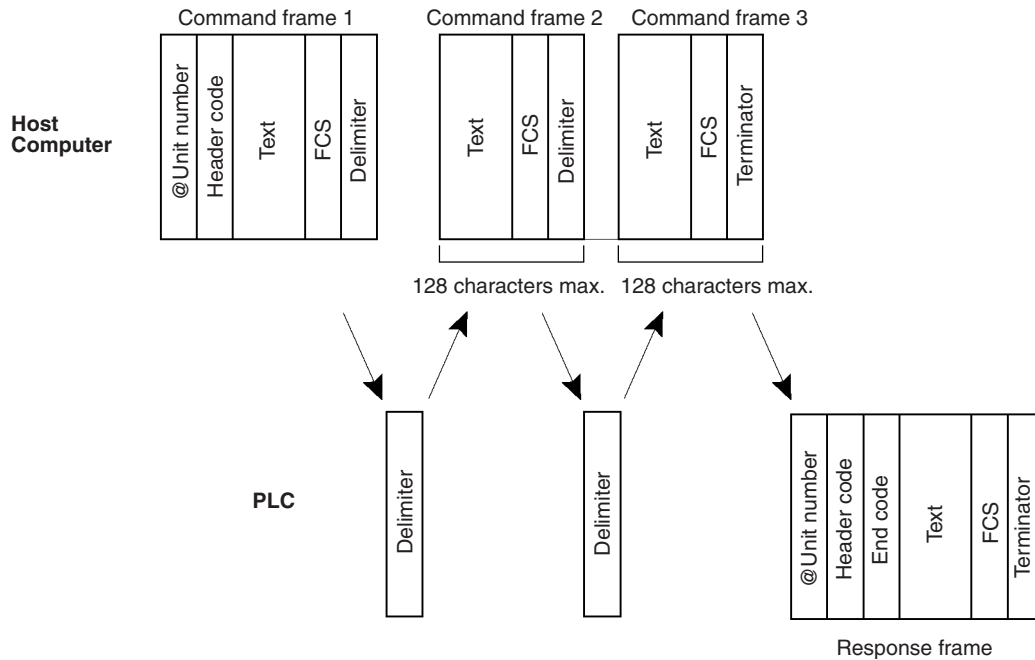

**Note** A “delimiter” is a CR code [CHR\$(13)] sent as a single character to indicate the middle of a command or response.

**Partitioned Responses**

If a response is more than 131 characters long, the response from the PLC is partitioned by returning a delimiter (CR code, CHR\$(13)) instead of a terminator at the end of each frame until the last one. A terminator is returned at the end of the last frame.

In the following example procedure, the response is partitioned into three frames.

- 1,2,3...**
1. When the PLC receives the command frame from the host computer, it returns response frame 1 with a delimiter (CR) at the end to the host computer.
  2. Only a delimiter (CR) is sent from the host computer to the PLC.
  3. When the PLC receives this delimiter (CR), it returns response frame 2 with a delimiter (CR) at the end to the host computer.
  4. Only a delimiter (CR) is sent from the host computer to the PLC.
  5. When the PLC receives this delimiter (CR), it returns response frame 3 with a terminator (\*CR) at the end to the host computer.

The following diagram shows the response format when there are more than 131 characters.

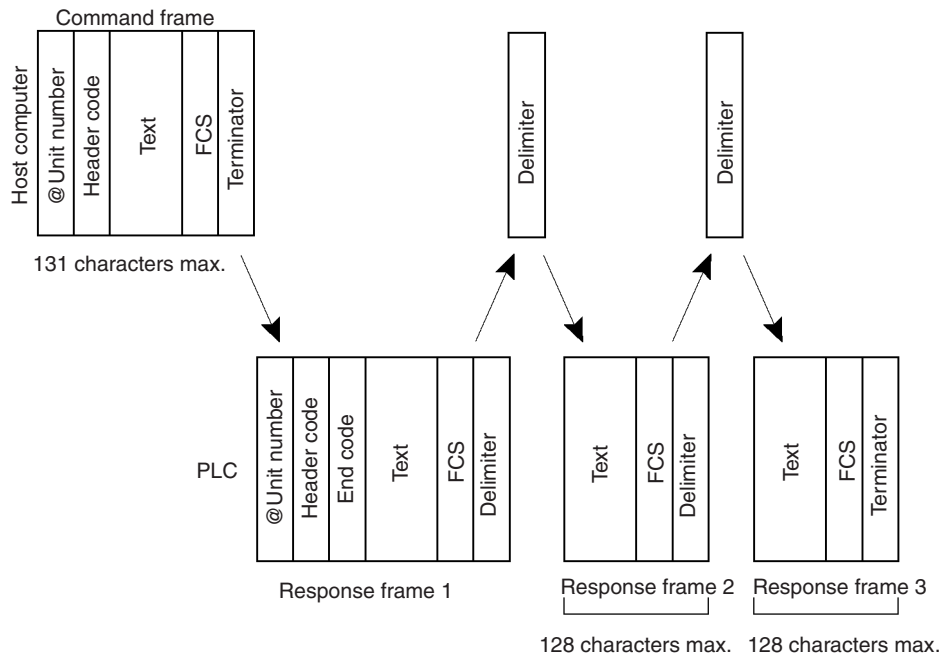

- Note**
1. Frames in partitioned commands or responses must have not more than 128 characters including the delimiter/terminator.
  2. Delimiters from the host computer are detected by the presence of a CR code. The delimiter will be detected even if there is data in front of it.

**FCS Calculations**

The PLC calculates the FCS (Frame Check Sequence) value for each command frame it receives, and it checks for errors by comparing that value with the FCS value sent with the command frame. The host computer must calculate the FCS value when sending a command frame.

Also, when checking for errors in response frames, the host computer must calculate the FCS value for each response frame it receives and compare that value to the FCS value sent in the response frame.

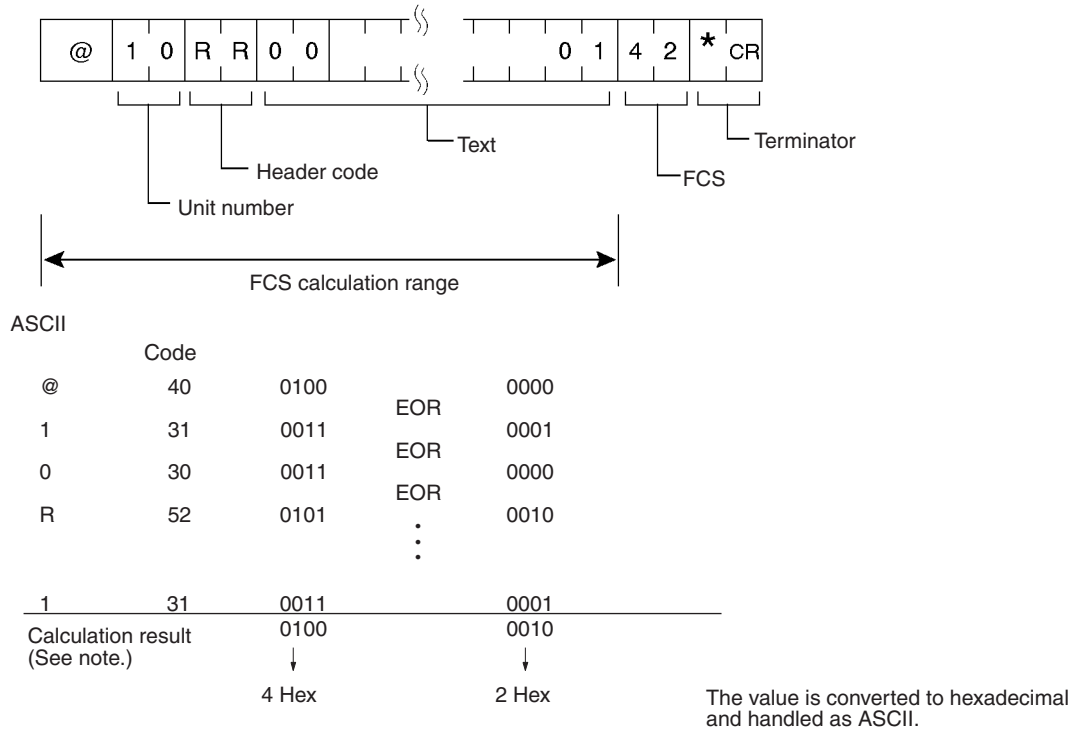

**Note** The FCS is an 8-bit value converted into two ASCII characters. The 8-bit value is the result of an exclusive OR sequentially performed between each character in a transmission, from the first character in the frame to the last character of the text in that frame. Non-ASCII data, however, may sometimes be sent in the text data. If the data length is 7 bits, the leftmost bit of each character is masked before the FCS is calculated.

## 2-3 Application Example

### Sending a Host Link Command from a Host Computer

In this example program, a Host Link command is sent from a host computer and a response is received.

```

10 'CS1 SAMPLE PROGRAM FOR EXCEPTION
20 CLOSE
30 CLS
40 OPEN "COM:E73"AS#1
50 *KEYIIN
60 INPUT "DATA-",S
70 IF S$="" THEN GOTO 190
80 PRINT "SEND DATA=";S$
90 ST$=S$
100 INPUT "SEND OK? Y or N?=",BS
110 IF B$="Y" THEN GOTO 130 ELSE GOTO *KEYIN
120 S$=ST$
130 PRINT #T,S$           Sends command to PLC.
140 INPUT #1,R$           Receives command from PLC.
150 PRINT "RECV DATA=";R$
160 IF MID$(R$,4,2)="EX" THEN GOTO 210   Identifies command.
170 IF RIGHT$(R$,1)<>"*" THEN S$="":GOTO 130
180 GOTO *KEYIN
190 CLOSE 1
200 END
210 PRINT "EXCEPTION!!DATA"
220 GOTO 140

```

#### Explanation

- 1,2,3...**
1. The host computer's transmission/reception program is started up, and the Host Link command is input.
  2. The Host Link command that was input is sent to the PLC, and the data that is received is displayed on the screen.

**Note** The example program up to this point does not include an error processing routine in case reception is not normal (e.g., if there is no FCS). Include error processing routines when creating an actual program.

```

400 *FCSCCHK
410 L=LEN(RESPONSE$)           Transmission/reception data
420 Q=0:FCSP$=""
430 A$=RIGHT$(RESPONSE$,1)
440 PRINT RESPONSE$,A$,L
450 IF A$="*" THEN LENG$=LEN(RESPONSE$)-3
    ELSE LENG$=LEN(RESPONSE$)-2
460 FCSP$=MID$(RESPONSE$,LENG$+1,2)   FCS data that is received
470 FOR I=1 TO LENG$               Number of characters in FCS calculation
480 Q=ASC(MID$(RESPONSE$,I,1))XOR Q
490 NEXT I
500 FCSD$=HEX$(Q)
510 IF LEN(FCSD$) =1 THEN FCSD$="0"+FCSD$   FCS calculation result
520 IF FCSD$<>FCSP$ THEN FCSP$="ERR"
530 PRINT "FCSD$=";FCSD$,"FCSP$=";FCSP$,"FCSD$=";FCSD$,"FCSP$=";FCSP$
    Normal FCS reception: " " (space); abnormal FCS reception: "ERR"
540 RETURN

```

## 2-4 Precautions when Reusing Programs from Earlier Models

Observe the following precautions when reusing host computer programs created for communications with C-series Host Link Units.

### 2-4-1 C-series Host Link Units with 1:N Host Link Format Selected

#### Using the CPU Unit's Built-in Peripheral Port or RS-232C Port

##### Number of Data Words per Frame

When I/O memory data is read with the following commands, the number of data words in each response frame is different for a C-series Host Link Unit compared to the built-in peripheral and RS-232C ports on CS/CJ-series CPU Units, serial port C on NSJ Controllers, built-in serial ports of N-type CP1E CPU Units, and serial ports 1 and 2 on the Option Board for CP-series CPU Units.

With a C-series Host Link Unit, the first frame can contain up to 29 words of data (text) and the following frames can contain up to 30 words of data (text). With the built-in peripheral and RS-232C ports on CS/CJ-series CPU Units, serial port C on NSJ Controllers, built-in serial ports of N-type CP1E CPU Units, and serial ports 1 and 2 on the Option Board for CP-series CPU Units, the first frame can contain up to 30 words of data (text) and the following frames can contain up to 31 words of data (text).

| Header code | Name   |
|-------------|--|
| RR          | CIO AREA READ  |
| RL          | LR AREA READ   |
| RH          | HR AREA READ   |
| RC          | TIMER/COUNTER PV READ  |
| RG          | TIMER/COUNTER STATUS READ<br>Note: The number of data words per response frame is different for the RG command than for the other C-mode commands. For details, see the table Words per Frame for C-mode RG Command below. |
| RD          | DM AREA READ   |
| RJ          | AR AREA READ   |

Because the Units do not have the same number of words per response frame, the data may not be read properly if a host computer program originally used with a C-series Host Link Unit is reused with a CS-series CPU Unit, CJ-series CPU Unit, CP-series CPU Unit, or NSJ Controller. In this case, be sure to edit the host computer program so that it is compatible with the frame format.

**Note** Serial Communications Boards and Units with version numbers 1.2 and later are equipped with a Host Link model compatibility selection function that changes the Host Link function's specifications to match the frame format of other Units in the Host Link. It is not necessary to edit an existing program if the Host Link model compatibility selection function is set to match the Host Link format used in the program. For details, see *Using a Serial Communications Board or Unit with Version Number 1.2 or Later* below.

**Words per Frame for C-mode Commands (Except RG Command)**

| Units                    | C Series   | CS/CJ Series  | CVM1 and CV Series   | Data words per frame  |              |
|--------------------------|--|---|--|-----------------------|--------------|
|                          |  |   |  | 1 <sup>st</sup> frame | Other frames |
| C-series Host Link Units | C200H-LK101/LK201/LK202 Host Link Units<br>C500-LK103/LK203 Host Link Units<br>3G2A5-LK101/LK201 Host Link Units<br>3G2A6-LK101/LK201/LK202 Host Link Units  | ---   | ---  | 29 words              | 30 words     |
| Other Boards and Units   | SRM1 built-in ports<br>CPM1 built-in ports<br>CPM1A built-in ports<br>CQM1-CPU□□ built-in ports<br>C200HS-CPU□□ built-in ports<br>C200HX/HG/HE-CPU□□ built-in ports<br>C200HW-COM□□ Communications Board ports | CS2H-CPU□□(-EIP) built-in ports<br>CJ2M-CPU1□ built-in ports<br>CJ2M-CPU3□ Serial Option Board<br>CS1G/H-CPU□□H built-in ports<br>CS1G/H-CPU□□-EV1 built-in ports<br>CS1D-CPU□□HA/SA/P/H/S built-in ports<br>CJ1G/H-CPU□□H built-in ports<br>CJ1G-CPU□□ built-in ports<br>CJ1M-CPU□□ built-in ports<br>CS1W-SCB21-V1/41-V1 (unit version: Pre-Ver. 1.2) Serial Communications Board ports<br>CS1W-SCU21-V1 (unit version: Pre-Ver. 1.2) Serial Communications Unit ports<br>CJ1W-SCU21/41 (unit version: Pre-Ver. 1.2) Serial Communications Unit ports | CVM1-CPU□□ built-in ports<br>CV-CPU□□ built-in ports<br>CV500-LK201 Host Link Unit | 30 words              | 31 words     |

**Words per Frame for C-mode RG Command**

| Units                    | C Series  | CS/CJ Series  | CVM1 and CV Series   | Data words per frame  |              |
|--------------------------|---|---|--|-----------------------|--------------|
|                          |   |   |  | 1 <sup>st</sup> frame | Other frames |
| C-series Host Link Units | C200H-LK101/LK201/LK202 Host Link Units   | ---   | ---  | 89 words              | 89 words     |
|                          | C500-LK103/LK203 Host Link Units  | ---   | ---  | 89 words              | 60 words     |
|                          | 3G2A5-LK101/LK201 Host Link Units<br>3G2A6-LK101/LK201/LK202 Host Link Units  | ---   | ---  | 89 words              | 60 words     |
| Other Boards and Units   | SRM1 built-in ports<br>CPM1 built-in ports<br>CPM1A built-in ports<br>CQM1-CPU□□ built-in ports<br>CQM1H-CPU□□ built-in ports<br>CQM1H-SCB□□ built-in ports<br>C200HX/HG/HE-CPU□□ built-in ports<br>C200HW-COM□□ Communications Board ports | CS2H-CPU□□(-EIP) built-in ports<br>CJ2M-CPU1□ built-in ports<br>CJ2M-CPU3□ Serial Option Board<br>CS1G/H-CPU□□H built-in ports<br>CS1G/H-CPU□□-EV1 built-in ports<br>CS1D-CPU□□HA/SA/P/H/S built-in ports<br>CJ1G/H-CPU□□H built-in ports<br>CJ1G-CPU□□ built-in ports<br>CJ1M-CPU□□ built-in ports<br>CS1W-SCB21-V1/41-V1 (unit version: Pre-Ver. 1.2) Serial Communications Board ports<br>CS1W-SCU21-V1 (unit version: Pre-Ver. 1.2) Serial Communications Unit ports<br>CJ1W-SCU21/41 (unit version: Pre-Ver. 1.2) Serial Communications Unit ports | CVM1-CPU□□ built-in ports<br>CV-CPU□□ built-in ports<br>CV500-LK201 Host Link Unit | 121 words             | 125 words    |

**Note** There are several exceptions to the number of words per frame values shown in the table above:

The following responses are returned when reading 246 words of Timer/Counter Completion Flags through CS/CJ-series CPU Unit built-in ports, CS/CJ-series Serial Communications Units/Boards, C200HX/HG/HE CPU Unit built-in ports, or C200HS CPU Unit built-in ports.

| 1 <sup>st</sup> frame | 2 <sup>nd</sup> frame | 3 <sup>rd</sup> frame |
|-----------------------|-----------------------|-----------------------|
| 121 words             | 124 words             | 1 word                |

The second-to-last frame contains 124 data words and the last frame contains 1 word. This also applies when the number of words is 246 + a multiple of 125 (i.e., 371 words, 496 words, 621 words, etc.).

The following responses are returned when reading 121 words of Timer/Counter Completion Flags through CS/CJ-series Unit built-in ports.

| 1 <sup>st</sup> frame | 2 <sup>nd</sup> frame |
|-----------------------|-----------------------|
| 120 words             | 1 word                |

The following responses are returned when reading 121 words or 246 words through CVM1 and CV-series CPU Unit built-in ports or CVM1/CV-series Host Link Units.

**Number of Words = 121**

| 1 <sup>st</sup> frame | 2 <sup>nd</sup> frame     |
|-----------------------|---------------------------|
| 121 words             | 0 words (terminator only) |

**Number of Words = 246**

| 1 <sup>st</sup> frame | 2 <sup>nd</sup> frame | 3 <sup>rd</sup> frame     |
|-----------------------|-----------------------|---------------------------|
| 121 words             | 125 words             | 0 words (terminator only) |

The second-to-last frame contains 125 data words and the last frame contains the terminator only. This also applies when the number of words is 246 + a multiple of 125 (i.e., 371 words, 496 words, 621 words, etc.). For responses containing the terminator only, "00\*CR" (00 = FCS, CR = carriage return) is returned.

**Response Format for MS Command**

With the MS command (STATUS READ), the response data format when using CVM1 or CV-series built-in ports or Host Link Units, is different from the response data format when using other Units.

When a CVM1/CV CPU Unit's built-in Host Link port or CVM1/CV Series Host Link Unit is used and an FAL or FALS instruction has not been executed, spaces (ASCII code 20 hex) will be included in the response data for the FAL/FALS message. With all other Host Link Units, the FAL/FALS message data is included in the response only when an FAL or FALS instruction has been executed.

**Using a Pre-Ver. 1.2 Serial Communications Board or Unit**

The response formats are the same as described above under the heading *Using the CPU Unit's Built-in Peripheral Port or RS-232C Port*.

**Using a Serial Communications Board or Unit with Version Number 1.2 or Later**

The Serial Communications Board or Unit's Host Link function can be made completely compatible with the existing PLC's Host Link function by setting the appropriate Host Link mode (1:N or 1:1 Host Link) and the Host Link model compatibility mode.

**Host Link Model Compatibility Selection Function**

Serial Communications Boards and Units with version Ver. 1.2 and later are equipped with a Host Link model compatibility selection function. This function switches the Board or Unit's Host Link specifications to match the specifications of an existing Host Link program that is being reused. The following specifications can be switched by the Host Link model compatibility function.

- Words per Response Frame

Sets the number of data words per response frame when receiving the following I/O memory read commands (RR, RL, RH, RC, RD, RJ, or RG).



- Sets the response frame format for the STATUS READ command (MS), which varies when an FAL or FALS instruction has not been executed.

**Host Link Model Compatibility Modes**

| Host link model compatibility mode | Host link model (Model used as basis for host computer's program)   | RR, RL, RH, RC, RD, and RJ commands |                       | RG command            |                       | MS command (see note) |
|------------------------------------|---|-------------------------------------|-----------------------|-----------------------|-----------------------|-----------------------|
|                                    |   | Data words per response frame       |                       |                       |                       | Response data format  |
|                                    |   | 1 <sup>st</sup> frame               | 2 <sup>nd</sup> frame | 1 <sup>st</sup> frame | 2 <sup>nd</sup> frame |                       |
| A mode (CS, CJ, and C)             | C Series<br>SRM1 built-in ports<br>CPM1 built-in ports<br>CPM1A built-in ports<br>CQM1-CPU□□ built-in ports<br>C200HS-CPU□□ built-in ports<br>C200HX/HG/HE-CPU□□ built-in ports<br>C200HW-COM□□ Communications Board ports<br>CS/CJ Series<br>CS2H-CPU□□(-EIP) built-in ports<br>CJ2M-CPU1□ built-in ports<br>CJ2M-CPU3□ Serial Option Board<br>CS1G/H-CPU□□H built-in ports<br>CS1G/H-CPU□□-EV1 built-in ports<br>CS1D-CPU□□HA/SA/P/H/S built-in ports<br>CJ1G/H-CPU□□H built-in ports<br>CJ1G-CPU□□ built-in ports<br>CJ1M-CPU□□ built-in ports<br>CS1W-SCB21-V1/41-V1 (unit version: Pre-Ver. 1.2) Serial Communications Board ports<br>CS1W-SCU21-V1 (unit version: Pre-Ver. 1.2) Serial Communications Unit ports<br>CJ1W-SCU21/41 (unit version: Pre-Ver. 1.2) Serial Communications Unit ports | 30 words                            | 31 words              | 121 words             | 125 words             | Variable length       |
| B mode (CVM1/CV)                   | CVM1-CPU□□ built-in ports<br>CV-CPU□□ built-in ports<br>CV500-LK201 Host Link Unit  |                                     |                       |                       |                       | Fixed length          |
| C mode (C200H)                     | C200H-LK101/LK201/LK202 Host Link Units   | 29 words                            | 30 words              | 89 words              | 89 words              | Variable length       |
| D mode (C500/C120)                 | C500-LK103/LK203 Host Link Units<br>3G2A5-LK101/LK201 Host Link Units<br>3G2A6-LK101/LK201/LK202 Host Link Units  |                                     |                       | 89 words              | 60 words              |                       |

**Note** When the MS command reads the CPU Unit's status data and an FAL or FALS instruction has not been executed, spaces (ASCII code 20 hex) are included as the FAL/FALS message in the response frame for some models (fixed length response in the table above). In the other models, no data is included as the FAL/FALS message in the response frame (variable length response frame) if an FAL or FALS instruction has not been executed.

**Relationship to the 1:N Host Link/1:1 Host Link Setting**

The following table shows the allowed Host Link format (1:N Host Link/1:1 Host Link) settings for each Host Link model compatibility setting.

| Host link model compatibility mode          | Host link format   |
|---|--|
| A mode (CS, CJ, and C) and B mode (CVM1/CV) | Only the 1:N Host Link format can be used.                               |
| C mode (C500/C120) and D mode (C200H)       | Either the 1:N Host Link format or 1:1 Host Link format can be selected. |

**Settings for an Example Unit Replacement**

Use the following settings when the existing host computer was created for a system with C500-LK103/LK203 Host Link Units and/or 3G2A5-LK101/LK201 Host Link Units, a new Serial Communications Board or Unit (Ver. 1.2 or later) is being used, and the Host Link format is 1:1 Host Link.

- Host link 1:N format/1:1 format setting: 1 (1:1 Host Link format)
- Host link model compatibility mode setting: 3 (C mode (C500/C120))

**2-4-2 C-series Host Link Units with 1:1 Host Link Format Selected**

**Using the CPU Unit's Built-in Peripheral Port or RS-232C Port**

Only the 1:N Host Link format is supported by the CPU Unit's built-in peripheral port and RS-232C port. A host computer program cannot be used if it was developed for a 1:1 Host Link.

**Using a Pre-Ver. 1.2 Serial Communications Board or Unit**

Only the 1:N Host Link format is supported by Pre-Ver. 1.2 Serial Communications Boards and Units. A host computer program cannot be used if it was developed for a 1:1 Host Link.

**Using a Serial Communications Board or Unit with Version Number 1.2 or Later**

The Serial Communications Boards and Units with version number 1.2 or later can be set to operate in 1:1 Host Link mode, so a host computer program developed for a 1:1 Host Link with C-series PLCs (C200H, C1000H, and C2000H) can be reused in a CS/CJ Series Host Link. (The 1:1 Host Link for-

mat can be selected with the 1:N format/1:1 format setting in the allocated DM Area settings.)

| Host link format | Usage  | Applicable PLC models  | Remarks  |
|------------------|--|--|--|
| 1:N format       | With this Host Link format, the connection configuration (host: PLC) can be either 1:1 or 1:N. Earlier versions of these Boards/Units supported only the 1:N format. | <p>C Series</p> <ul style="list-style-type: none"> <li>SRM1 built-in ports</li> <li>CPM1 built-in ports</li> <li>CPM1A built-in ports</li> <li>CQM1-CPU□□ built-in ports</li> <li>C200HS-CPU□□ built-in ports</li> <li>C200HX/HG/HE-CPU□□ built-in ports</li> <li>C200HW-COM□□ Communications Board ports</li> </ul> <p>CS/CJ Series</p> <ul style="list-style-type: none"> <li>CJ2H-CPU□□(-EIP) built-in ports</li> <li>CJ2M-CPU1□ built-in ports</li> <li>CJ2M-CPU3□ Serial Option Board</li> <li>CS1G/H-CPU□□H built-in ports</li> <li>CS1G/H-CPU□□-EV1 built-in ports</li> <li>CS1D-CPU□□HA/SA/P/H/S built-in ports</li> <li>CJ1G/H-CPU□□H built-in ports</li> <li>CJ1G-CPU□□ built-in ports</li> <li>CJ1M-CPU□□ built-in ports</li> </ul> | Only the 1:N Host Link format is supported by the built-in ports on CPU Units of CS/CJ, C200HS, C200HX/HG/HE, CPM□, and CQM1□ PLCs as well as the ports on Host Link Units and Serial Communications Boards. |
|                  |  | <p>Earlier versions (unit version: Pre-Ver. 1.2)</p> <ul style="list-style-type: none"> <li>CS1W-SCB21-V1/41-V1 Serial Communications Board ports</li> <li>CS1W-SCU21-V1 Serial Communications Unit ports</li> <li>CJ1W-SCU21/41 Serial Communications Unit ports</li> </ul>   | Earlier versions of the Serial Communications Boards/Units support only the 1:N Host Link format.  |
|                  |  | <p>CVM1/CV Series</p> <ul style="list-style-type: none"> <li>CVM1-CPU□□ built-in ports</li> <li>CV-CPU□□ built-in ports</li> <li>CV500-LK201 Host Link Unit</li> </ul>   | Only the 1:N Host Link format is supported by the built-in ports on CPU Units of CVM1/CV Series PLCs as well as the ports on Host Link Units and Serial Communications Units/Boards.                         |
|                  |  | <p>C Series</p> <ul style="list-style-type: none"> <li>C500-LK103/LK203 Host Link Units</li> <li>3G2A5-LK101/LK201 Host Link Units</li> <li>3G2A6-LK101/LK201/LK202 Host Link Units</li> </ul>   | Either the 1:N Host Link or 1:1 Host Link format can be selected with these C-series Host Link Units.  |
|                  |  | <p>C Series</p> <ul style="list-style-type: none"> <li>C200H-LK101/LK201/LK202 Host Link Units</li> </ul>  |  |
| 1:1 format       | With this Host Link format, the connection configuration (host: PLC) can be 1:1 only.  | <p>C Series</p> <ul style="list-style-type: none"> <li>C500-LK103/LK203 Host Link Units</li> <li>3G2A5-LK101/LK201 Host Link Units</li> <li>3G2A6-LK101/LK201/LK202 Host Link Units</li> </ul>   | Either the 1:N Host Link or 1:1 Host Link format can be selected with these C-series Host Link Units.  |
|                  |  | <p>C Series</p> <ul style="list-style-type: none"> <li>C200H-LK101/LK201/LK202 Host Link Units</li> </ul>  |  |

**Note** The following diagrams show the differences in the command and response frames with the 1:N Host Link format and 1:1 Host Link format.

**1:N Format**

- Command

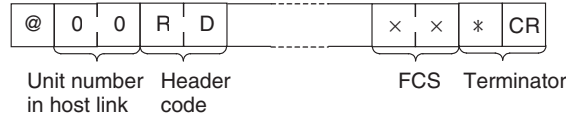

- Response

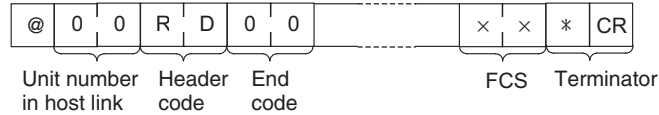

**1:1 Format**

As shown in the following diagrams, the 1:1 format is equivalent to the 1:N format without the @ character, Host Link unit number, and FCS byte.

- Command format

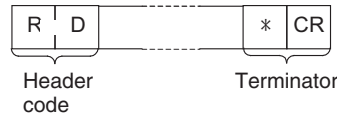

- Response format

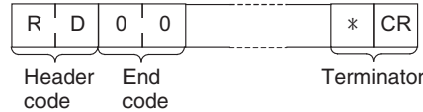

**2-4-3 C-mode Command Support**

Use the following table as reference when reusing programs for host computers developed for earlier Host Link models.

- If a command is not supported for the new model of PLC, consider using another C-mode or FINS command.
- Even if the command is supported, differences may exist in the data sizes that can be processed or in the meaning of the values if the models or Series vary.
- Refer to the applicable operation manuals for details.

**Note** Refer to information on the previous page for commands with “Caution” in the *Frame data size* column.

| Frame data size | Header code | Name                      | CJ2 | CS/CJ Series | C Series                               |   |                                  |                            |                             |                      |                             |         |      |                 | CVM1 and CV Series |     |                      |
|-----------------|-------------|---------------------------|-----|--------------|--|---|----------------------------------|----------------------------|-----------------------------|----------------------|-----------------------------|---------|------|-----------------|--------------------|-----|----------------------|
|                 |             |                           |     |              | C200HE /HG/HX                          | C200HS  | C120                             | C200H C200HS C200HE /HG/HX | C500                        | C1000H C2000H        | C500F                       | C1000HF | CQM1 | SRM1 CPM1 CPM1A | None or V1         | V2  | CV500 Host Link Unit |
|                 |             |                           |     |              | CPU Unit or Serial Communications Unit | CPU Unit or Serial Communications Board or Unit | CPU Unit or Communications Board | CPU Unit                   | C120 (3G2A6) Host Link Unit | C200H Host Link Unit | C500 (3G2A5) Host Link Unit |         |      | CPU Unit        |                    |     |                      |
| --              | --          | --                        | --  | --           | --                                     | --  |                                  |                            | --                          | --                   | --                          | --      |      |                 |                    |     |                      |
| Caution         | RR          | CIO AREA READ             | Yes | Yes          | Yes                                    | Yes   | Yes                              | Yes                        | Yes                         | Yes                  | Yes                         | Yes     | Yes  | Yes             | Yes                | Yes | Yes                  |
| Caution         | RL          | LR AREA READ              | Yes | Yes          | Yes                                    | Yes   | Yes                              | Yes                        | Yes                         | Yes                  | Yes                         | Yes     | Yes  | Yes             | No                 | Yes | No                   |
| Caution         | RH          | HR AREA READ              | Yes | Yes          | Yes                                    | Yes   | Yes                              | Yes                        | Yes                         | Yes                  | Yes                         | Yes     | Yes  | Yes             | No                 | Yes | No                   |
| Caution         | RC          | TIMER/COUNTER PV READ     | Yes | Yes          | Yes                                    | Yes   | Yes                              | Yes                        | Yes                         | Yes                  | Yes                         | Yes     | Yes  | Yes             | Yes                | Yes | Yes                  |
| Caution         | RG          | TIMER/COUNTER STATUS READ | Yes | Yes          | Yes                                    | Yes   | Yes                              | Yes                        | Yes                         | Yes                  | Yes                         | Yes     | Yes  | Yes             | Yes                | Yes | Yes                  |
| Caution         | RD          | DM AREA READ              | Yes | Yes          | Yes                                    | Yes   | Yes                              | Yes                        | Yes                         | Yes                  | Yes                         | Yes     | Yes  | Yes             | Yes                | Yes | Yes                  |
| Caution         | RJ          | AR AREA READ              | Yes | Yes          | Yes                                    | Yes   | No                               | Yes                        | No                          | Yes                  | No                          | Yes     | Yes  | Yes             | Yes                | Yes | Yes                  |
| OK              | RE          | EM AREA READ              | Yes | Yes          | Yes                                    | No  | No                               | No                         | No                          | No                   | No                          | No      | No   | No              | No                 | No  | No                   |
| NA              | RX          | FILE MEMORY DELUXE READ   | No  | No           | No                                     | No  | No                               | No                         | No                          | Yes                  | No                          | Yes     | No   | No              | No                 | No  | No                   |
| NA              | RF          | FILE MEMORY READ          | No  | No           | No                                     | No  | No                               | No                         | No                          | Yes                  | No                          | Yes     | No   | No              | No                 | No  | No                   |
| NA              | CR          | DM AREA READ (FIXED)      | No  | No           | No                                     | No  | No                               | No                         | No                          | Yes                  | No                          | Yes     | No   | No              | No                 | Yes | No                   |
| NA              | GM          | DM SIZE CHANGE            | No  | No           | No                                     | No  | No                               | No                         | No                          | No                   | Yes                         | Yes     | No   | No              | No                 | No  | No                   |
| Caution         | WR          | CIO AREA WRITE            | Yes | Yes          | Yes                                    | Yes   | Yes                              | Yes                        | Yes                         | Yes                  | Yes                         | Yes     | Yes  | Yes             | Yes                | Yes | Yes                  |
| Caution         | WL          | LR AREA WRITE             | Yes | Yes          | Yes                                    | Yes   | Yes                              | Yes                        | Yes                         | Yes                  | Yes                         | Yes     | Yes  | Yes             | No                 | Yes | No                   |
| Caution         | WH          | HR AREA WRITE             | Yes | Yes          | Yes                                    | Yes   | Yes                              | Yes                        | Yes                         | Yes                  | Yes                         | Yes     | Yes  | Yes             | No                 | Yes | No                   |
| Caution         | WC          | TIMER/COUNTER PV WRITE    | Yes | Yes          | Yes                                    | Yes   | Yes                              | Yes                        | Yes                         | Yes                  | Yes                         | Yes     | Yes  | Yes             | Yes                | Yes | Yes                  |
| Caution         | WD          | DM AREA WRITE             | Yes | Yes          | Yes                                    | Yes   | Yes                              | Yes                        | Yes                         | Yes                  | Yes                         | Yes     | Yes  | Yes             | Yes                | Yes | Yes                  |
| Caution         | WJ          | AR AREA WRITE             | Yes | Yes          | Yes                                    | Yes   | No                               | No                         | No                          | Yes                  | No                          | Yes     | Yes  | Yes             | Yes                | Yes | Yes                  |
| OK              | WE          | EM AREA WRITE             | Yes | Yes          | Yes                                    | No  | No                               | No                         | No                          | No                   | No                          | No      | No   | No              | No                 | No  | No                   |
| NA              | R#          | TIMER/COUNTER SV READ 1   | Yes | Yes          | Yes                                    | Yes   | Yes                              | Yes                        | Yes                         | Yes                  | Yes                         | Yes     | Yes  | Yes             | No                 | Yes | No                   |
| NA              | R\$         | TIMER/COUNTER SV READ 2   | Yes | Yes          | Yes                                    | Yes   | Yes                              | Yes                        | Yes                         | Yes                  | Yes                         | Yes     | Yes  | Yes             | No                 | Yes | No                   |
| NA              | R%          | TIMER/COUNTER SV READ 3   | Yes | Yes          | Yes                                    | Yes   | Yes                              | Yes                        | Yes                         | Yes                  | Yes                         | Yes     | Yes  | No              | No                 | Yes | No                   |
| NA              | W#          | TIMER/COUNTER SV CHANGE 1 | No  | Yes          | Yes                                    | Yes   | Yes                              | Yes                        | Yes                         | Yes                  | Yes                         | Yes     | Yes  | Yes             | No                 | Yes | No                   |

| Frame data size | Header code | Name                                  | CJ2 | CS/CJ Series | C Series                               |   |                                  |                            |                             |                      |                             |         |      |                 | CVM1 and CV Series |     |     |
|-----------------|-------------|---------------------------------------|-----|--------------|--|---|----------------------------------|----------------------------|-----------------------------|----------------------|-----------------------------|---------|------|-----------------|--------------------|-----|-----|
|                 |             |                                       |     |              | C200HE /HG/HX                          | C200HS  | C120                             | C200H C200HS C200HE /HG/HX | C500                        | C1000H C2000H        | C500F                       | C1000HF | QCM1 | SRM1 CPM1 CPM1A | None or V1         | V2  | --  |
|                 |             |                                       |     |              | CPU Unit or Serial Communications Unit | CPU Unit or Serial Communications Board or Unit | CPU Unit or Communications Board | CPU Unit                   | C120 (3G2A6) Host Link Unit | C200H Host Link Unit | C500 (3G2A5) Host Link Unit |         |      | CPU Unit        |                    |     |     |
| --              | --          | --                                    | --  | --           | --                                     | --  |                                  |                            | --                          | --                   |                             |         |      |                 |                    |     |     |
| NA              | W\$         | TIMER/COUNTER SV CHANGE 2             | No  | Yes          | Yes                                    | Yes   | Yes                              | Yes                        | Yes                         | Yes                  | Yes                         | Yes     | Yes  | Yes             | No                 | Yes | No  |
| NA              | W%          | TIMER/COUNTER SV CHANGE 3             | No  | Yes          | Yes                                    | Yes   | Yes                              | Yes                        | Yes                         | Yes                  | Yes                         | Yes     | Yes  | No              | No                 | Yes | No  |
| NA              | MS          | STATUS READ                           | Yes | Yes          | Yes                                    | Yes   | Yes                              | Yes                        | Yes                         | Yes                  | Yes                         | Yes     | Yes  | Yes             | Yes                | Yes | Yes |
| NA              | SC          | STATUS CHANGE                         | Yes | Yes          | Yes                                    | Yes   | Yes                              | Yes                        | Yes                         | Yes                  | Yes                         | Yes     | Yes  | Yes             | Yes                | Yes | Yes |
| NA              | MF          | ERROR READ                            | Yes | Yes          | Yes                                    | Yes   | Yes                              | Yes                        | Yes                         | Yes                  | Yes                         | Yes     | Yes  | Yes             | Yes                | Yes | Yes |
| NA              | KS          | FORCED SET                            | Yes | Yes          | Yes                                    | Yes   | Yes                              | Yes                        | Yes                         | Yes                  | Yes                         | Yes     | Yes  | Yes             | Yes                | Yes | Yes |
| NA              | KR          | FORCED RESET                          | Yes | Yes          | Yes                                    | Yes   | Yes                              | Yes                        | Yes                         | Yes                  | Yes                         | Yes     | Yes  | Yes             | Yes                | Yes | Yes |
| NA              | FK          | MULTIPLE FORCED SET/RESET             | Yes | Yes          | Yes                                    | Yes   | No                               | Yes                        | No                          | No                   | No                          | No      | Yes  | Yes             | No                 | Yes | No  |
| NA              | FR          | MULTIPLE FORCED SET/RESET STATUS READ | No  | No           | Yes                                    | Yes   | No                               | Yes                        | No                          | No                   | No                          | No      | No   | No              | No                 | No  | No  |
| NA              | KC          | FORCED SET/RESET CANCEL               | Yes | Yes          | Yes                                    | Yes   | Yes                              | Yes                        | Yes                         | Yes                  | Yes                         | Yes     | Yes  | Yes             | Yes                | Yes | Yes |
| NA              | MM          | PLC MODEL READ                        | Yes | Yes          | Yes                                    | Yes   | Yes                              | Yes                        | Yes                         | Yes                  | Yes                         | Yes     | Yes  | Yes             | Yes                | Yes | Yes |
| NA              | TS          | TEST                                  | Yes | Yes          | Yes                                    | Yes   | Yes                              | Yes                        | Yes                         | Yes                  | Yes                         | Yes     | Yes  | Yes             | Yes                | Yes | Yes |
| NA              | RP          | PROGRAM READ                          | Yes | Yes          | Yes                                    | Yes   | Yes                              | Yes                        | Yes                         | Yes                  | Yes                         | Yes     | Yes  | Yes             | Yes                | Yes | Yes |
| NA              | WP          | PROGRAM WRITE                         | Yes | Yes          | Yes                                    | Yes   | Yes                              | Yes                        | Yes                         | Yes                  | Yes                         | Yes     | Yes  | Yes             | Yes                | Yes | Yes |
| NA              | MI          | I/O TABLE CREATE                      | Yes | Yes          | Yes                                    | Yes   | Yes                              | Yes                        | Yes                         | Yes                  | Yes                         | Yes     | No   | No              | Yes                | Yes | Yes |
| NA              | QQMR/QQIR   | REGISTER/READ I/O MEMORY              | Yes | Yes          | Yes                                    | Yes   | Yes                              | Yes                        | Yes                         | Yes                  | Yes                         | Yes     | Yes  | Yes             | Yes                | Yes | Yes |
| NA              | XZ          | ABORT (command only)                  | Yes | Yes          | Yes                                    | Yes   | Yes                              | Yes                        | Yes                         | Yes                  | Yes                         | Yes     | Yes  | Yes             | Yes                | Yes | Yes |
| NA              | **          | INITIALIZE (command only)             | Yes | Yes          | Yes                                    | Yes   | Yes                              | Yes                        | Yes                         | Yes                  | Yes                         | Yes     | Yes  | Yes             | Yes                | Yes | Yes |
| NA              | IC          | Undefined command (response only)     | Yes | Yes          | Yes                                    | Yes   | Yes                              | Yes                        | Yes                         | Yes                  | Yes                         | Yes     | Yes  | Yes             | Yes                | Yes | Yes |
| NA              | EX          | TXD RESPONSE (response only)          | No  | No           | Yes                                    | No  | No                               | No                         | No                          | No                   | No                          | No      | No   | No              | No                 | No  | No  |
| NA              | FA          | FINS MESSAGE                          | Yes | Yes          | No                                     | No  | No                               | No                         | No                          | No                   | No                          | No      | No   | No              | Yes                | Yes | Yes |
| NA              | OF          | FINS MESSAGE (slave-initiated)        | Yes | Yes          | No                                     | No  | No                               | No                         | No                          | No                   | No                          | No      | No   | No              | Yes                | Yes | Yes |

**Note** When using CVM1 or CV-series built-in ports or Host Link Units, the response data format for the MS command (STATUS READ) is different from the format for other Units. For details, refer to 4-3-23 STATUS READ -- MS.

**Manuals for Host Link Operations**

| PLC                | Product                                   |   | Model (suffixes omitted)   | Manual type      | Catalog No. |
|--------------------|---|---|--|------------------|-------------|
| CS/CJ Series       | Communications commands (C-mode and FINS) | CPU Unit  | CJ2H-CPU□□(-EIP)<br>CJ2M-CPU□□<br>CS1G/H-CPU□□H<br>CS1G/H-CPU□□-EV1<br>CS1D-CPU□□HA<br>CS1D-CPU□□SA<br>CS1D-CPU□□P<br>CS1D-CPU□□H<br>CJ1M-CPU□□<br>CJ1G/H-CPU□□H<br>CJ1G-CPU□□ | Reference Manual | W342-E1     |
|                    |   | Serial Communications Unit/Board  | CS1W-SCB21-V1/41-V1<br>CS1W-SCU21-V1<br>CJ1W-SCU21/41  |                  |             |
|                    | Serial Communications Unit/Board          | CS1W-SCB21-V1/41-V1<br>CS1W-SCU21-V1<br>CJ1W-SCU21/41                           | Operation Manual   | W336-E1          |             |
| C200HX/HG/HE       | CPU Unit                                  | C200HX/HG/HE-CPU□□  | Operation Manual   | W303-E1          |             |
|                    |   | C200HX/HG/HE-CPU□□-Z  | Operation Manual   | W322-E1          |             |
| C200HS             | CPU Unit                                  | C200HS-CPU□□  | Operation Manual   | W235-E1          |             |
| C Series           | Host Link Units                           | C200H-LK101/201/202<br>C500-LK201/203<br>3G2A5-LK101/103<br>3G2A6-LK101/201/202 | System Manual  | W143-E1          |             |
| CQM1               | CPU Unit                                  | CQM1-CPU□□  | Programming Manual   | W228-E1          |             |
| CPM1               | CPU Unit                                  | CPM1-□□□□□  | Operation Manual   | W262-E1          |             |
| CPM1A              | CPU Unit                                  | CPM1A-□□□□□   | Operation Manual   | W317-E1          |             |
| SRM1               | CPU Unit                                  | SRM1-C□□  | Operation Manual   | W318-E1          |             |
| CVM1 and CV Series | CPU Unit                                  | CVM1/CV-CPU□□   | Operation Manual   | W205-E1          |             |
|                    | Host Link Unit                            | CV500-LK201   |  |                  |             |





# SECTION 3

## Overview of FINS Commands

This section provides an overview of FINS commands.

|        |  |    |
|--------|--|----|
| 3-1    | FINS Commands . . . . .  | 28 |
| 3-2    | Using FINS Commands . . . . .  | 31 |
| 3-2-1  | Issuing and using any command (CMND (490) instruction) . .               | 31 |
| 3-2-2  | Using with respect to a host computer connected by Host Link             | 32 |
| 3-3    | FINS Command and Response Frames . . . . .                               | 32 |
| 3-3-1  | FINS Command Frame Configuration . . . . .                               | 32 |
| 3-3-2  | FINS Response Frame Configuration . . . . .                              | 33 |
| 3-3-3  | Individual Items in Command/Response Frames . . . . .                    | 33 |
| 3-4    | Settings for Sending FINS Commands . . . . .                             | 35 |
| 3-4-1  | FINS Command and Response Formats . . . . .                              | 35 |
| 3-4-2  | Addresses in FINS Commands . . . . .                                     | 36 |
| 3-4-3  | Other FINS Command Settings . . . . .                                    | 42 |
| 3-4-4  | CMND(490) Setting Example . . . . .                                      | 43 |
| 3-5    | FINS Commands with Host Link Protocol . . . . .                          | 44 |
| 3-5-1  | Connection Configurations . . . . .                                      | 44 |
| 3-5-2  | Overview of Command and Response Frames . . . . .                        | 45 |
| 3-5-3  | Sending Commands from the Computer to the CPU Unit. . . . .              | 46 |
| 3-5-4  | Sending FINS Commands to the Host Computer<br>from the CPU Unit. . . . . | 50 |
| 3-5-5  | Sending Commands from the CPU Unit . . . . .                             | 51 |
| 3-5-6  | Command Format Received by the Host Computer . . . . .                   | 56 |
| 3-5-7  | Response Format Returned by the Host Computer . . . . .                  | 58 |
| 3-5-8  | Flags for Network Communications . . . . .                               | 59 |
| 3-5-9  | Timing of Commands to Host Computers . . . . .                           | 60 |
| 3-5-10 | Programming Example . . . . .  | 63 |
| 3-6    | Serial Gateway Overview. . . . .   | 67 |
| 3-6-1  | Overview . . . . .   | 67 |
| 3-6-2  | Types of Protocol Conversion . . . . .                                   | 68 |
| 3-6-3  | Converting FINS to CompoWay/F. . . . .                                   | 68 |
| 3-6-4  | Converting FINS to Modbus-RTU . . . . .                                  | 71 |
| 3-6-5  | Converting from FINS to Modbus-ASCII . . . . .                           | 74 |
| 3-6-6  | Converting from FINS to Host Link FINS . . . . .                         | 75 |
| 3-6-7  | Treating Serial Communications Paths as Networks . . . . .               | 79 |
| 3-6-8  | Using a PLC as the Target . . . . .                                      | 80 |
| 3-6-9  | Using a non-PLC Component as the Target . . . . .                        | 82 |
| 3-6-10 | Explanation . . . . .  | 85 |
| 3-7    | Communications Frames . . . . .  | 87 |
| 3-7-1  | CompoWay/F . . . . .   | 87 |
| 3-7-2  | Modbus-RTU . . . . .   | 88 |
| 3-7-3  | Modbus-ASCII . . . . .   | 89 |
| 3-7-4  | Host Link FINS . . . . .   | 90 |
| 3-7-5  | Sending Commands Using the CMND(490) Instruction . . . . .               | 91 |

### 3-1 FINS Commands

FINS commands form a command system for message services across different OMRON networks. They can be used for various control operations, such as sending and receiving data, changing operating modes, executing forced set and forced reset operations, performing file operations, and so on. FINS commands make it possible to freely communicate with Units in various networks and on CPU Racks by simply specifying the network, node, and unit.

FINS commands have the following features:

- 1,2,3...
1. They are defined in the application level and do not depend on lower levels (i.e., the physical and data link levels). This allows them to be used across a variety of networks and CPU buses. Specifically, they can be used with Ethernet, Controller Link, and Host Link networks, and between CPU Units and CPU Bus Units.

Note FINS commands can be sent with UDP/IP headers when using Ethernet and with Host Link command headers when using Host Link.

2. FINS commands can be used to access various kinds of devices besides CPU Units. Devices such as CPU Units, CPU Bus Units, personal computers (boards), and Inner Boards can be identified and specified by their unit addresses.

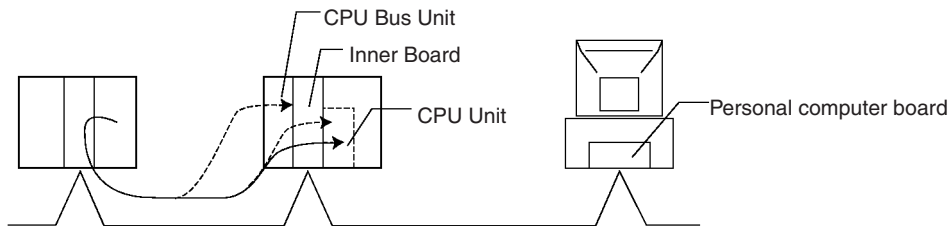

3. FINS commands support network relay operations, so they can pass through a network hierarchy to access devices on up to three network levels (including the local network).

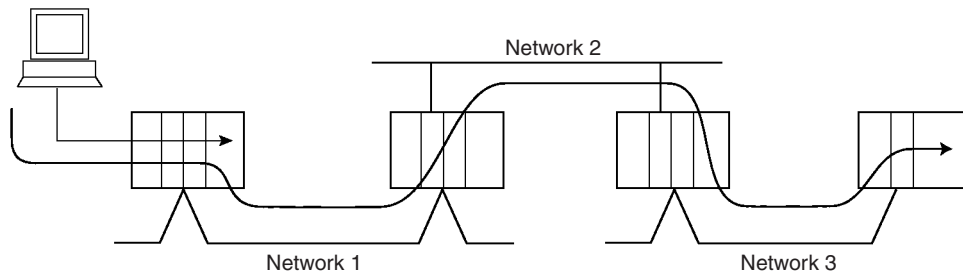

**Note** With CS1-H CPU Units, CJ1-H CPU Units, CJ1M CPU Units, CS1D CPU Units (for Single CPU Systems) with unit version 2.0 or later, CP-series CPU Units, or NSJ Controllers, devices can be accessed on up to 8 network levels. When the destination of a FINS command is a CPU Unit, the command can be sent through as many as 8 network levels. When the destination of a FINS command is a node other than a CPU Unit, the command can be sent through a maximum of 3 network levels.

- The following table shows the maximum number of network levels that can be crossed by various PLC models.

| PLC model  | Network levels<br>(Gateway counter setting)   |
|--|---|
| CS1-H CPU Units, CJ1-H CPU Units, CJ1M CPU Units with unit version 3.0 or later,<br>CS1D CPU Units (for Single CPU Systems) with unit version 4.0 or later,<br>CP-series CPU Units*1,<br>NSJ Controllers | It is possible to select a maximum of either 8 levels or 3 levels. (Set with CX-Programmer Ver. 5.0.) |
| CS1-H CPU Units, CJ1-H CPU Units, CJ1M CPU Units, and CS1D CPU Units (for Single CPU Systems) with unit version 2.0  | Setting fixed at 8 levels max.  |
| Pre-Ver. 20. CS/CJ-series CPU Units,<br>CS1D CPU Units (for Duplex-CPU Systems),<br>CVM1/CV-series CPU Units   | Setting fixed at 3 levels max.  |

\*1: Not possible with a CP1E CPU unit.

- When crossing up to 3 network levels, the CS1-H CPU Units, CJ1-H CPU Units, CJ1M CPU Units, CS1D CPU Units (for Single CPU Systems) with unit version 2.0 and later, CP-series CPU Units, or NSJ Controllers can be combined with other models.

When crossing 4 to 8 network levels, configure the system with only CS1-H CPU Units, CJ1-H CPU Units, CJ1M CPU Units, CS1D CPU Units (for Single CPU Systems) with unit version 2.0 and later, CP-series CPU Units, or NSJ Controllers. (Other models cannot be combined in the network with CS1-H CPU Units, CJ1-H CPU Units, CJ1M CPU Units, CS1D CPU Units (for Single CPU Systems) with unit version 2.0 and later, CP-series CPU Units, or NSJ Controllers.)

If earlier models are used, a routing error (end codes 0501 to 0504) will occur and the response may not be returned to the node that sent the command.

For details, refer to *1-4-2 Communications through a Maximum of 8 Network Levels* in the *CS Series PLC Operation Manual* or the *CJ Series PLC Operation Manual*.

**Types of FINS Commands**

There are basically two kinds of FINS commands: Those addressed to CPU Units and those addressed to CPU Bus Units. Among FINS commands for CPU Units, there are commands addressed to the various models of CPU Unit, such as the CS/CJ/CP-series CPU Units, NSJ Controllers, CV-series CPU Units, C200HX/HG/HE CPU Units, and so on. The basic code system is the same, but the detailed specifications vary according to the CPU Unit.

Among FINS commands for CPU Bus Units, there are commands addressed to Controller Link Units, to DeviceNet Master Units, to Ethernet Units, and so on.

**FINS Commands Addressed to CS/CJ/CP-series CPU Units and NSJ Controllers**

CS/CJ/CP-series CPU Units and NSJ Controllers can receive FINS commands from a PLC (CS/CJ, CVM1/CV, or C200HX/HG/HE(-Z) CPU Unit) or computer on another network or from a host computer connected directly to the local network.

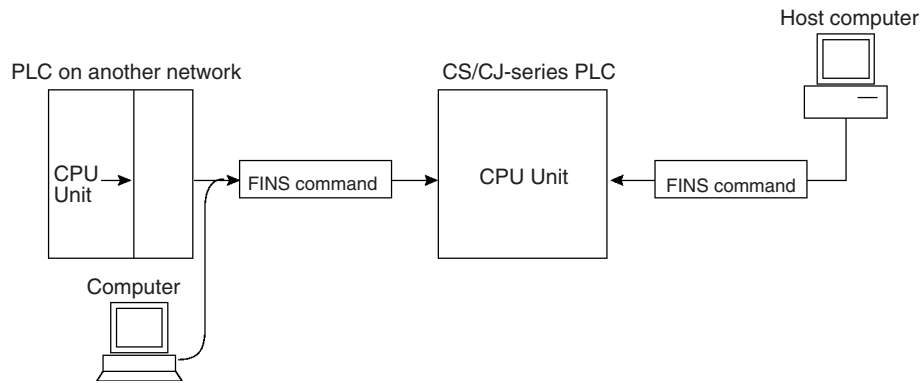

- 1,2,3...
1. A FINS command sent from a PLC or computer on another network is transmitted to the CPU Unit from the Backplane of the CPU Rack, via a Communications Unit (Controller Link Unit, Ethernet Unit, etc.)
  2. FINS commands sent from a host computer to a CPU Unit are sent with a Host Link header code and a terminator (as in the Host Link communications mode).

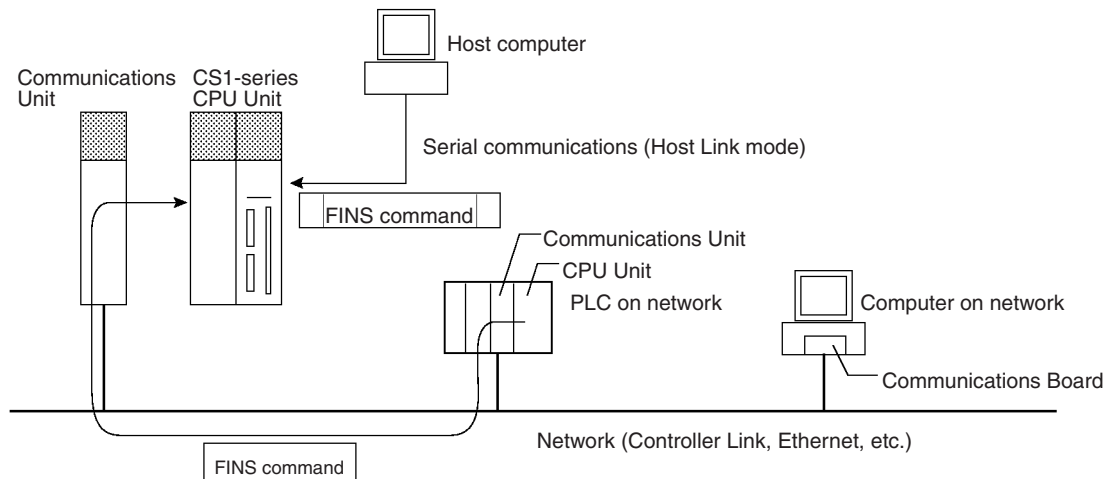

The FINS commands available for CS/CJ/CP-series CPU Units and NSJ Controllers fall into the following broad categories. (Refer to the relative operation manuals for FINS commands addressed to other Units and Boards.)

- I/O memory area reading and writing
- Parameter area reading and writing
- Program area reading and writing
- Operating mode changes
- Machine configuration reading
- CPU Unit status reading
- Time data access
- Message reading and clearing
- Access rights acquisition and release
- Error log reading and clearing
- File operations
- Forced set/reset

**Note** When the Ethernet option board (CP1W-CIF41) is used, a FINS command issued from a PLC or computer on the network can be received via the Ethernet option board, but cannot be issued via the Ethernet option board.

### 3-2 Using FINS Commands

FINS commands addressed to CPU units are issued to CS/CJ/CP-series CPU units and NSJ Controllers by executing the instruction for the FINS command (SEND/RCV/CMND instruction) from a program of another PLC (CPU unit) on the network.

Executing a FINS command addressed to a CPU unit can be used for the following:

- Issuing and using any command (CMND instruction)
- Using with respect to a host computer connected by Host Link

#### 3-2-1 Issuing and using any command (CMND (490) instruction)

The procedure for execution by CMND instruction is described below.

- 1,2,3...
1. Store the command format of the FINS command (i.e., the command data) in an I/O memory area, such as the DM area.
  2. In the same way, store the control data (number of bytes of transmission data, destination address, etc.) in an I/O memory area, such as the DM area.
  3. Designate S (first command word), D (first response word), and C (first control word) for the CMND(490) operands, and execute the instruction.
  4. When the FINS response is returned from the destination node (a CS/CJ/CP-series CPU Unit or an NSJ Controller), the data will be stored according to the response format beginning at the first response word.

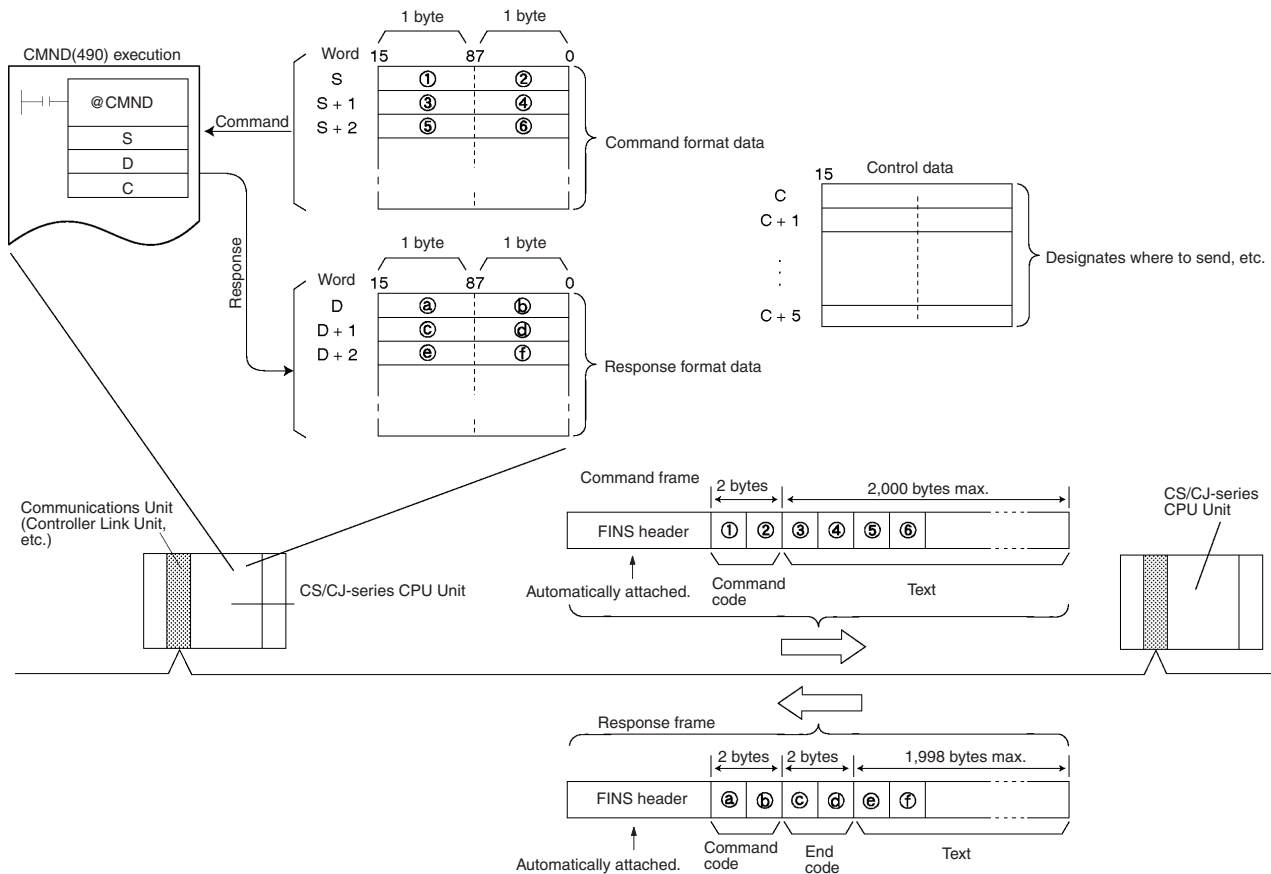

**Note** FINS commands and responses are handled as binary data, and data is sent and received in binary format. (Host Link communications, however, are basically in ASCII.)

### 3-2-2 Using with respect to a host computer connected by Host Link

With Host Link communications, a FINS command frame with a Host Link header and a terminator is sent from a host computer to a CS/CJ/CP-series CPU Unit or NSJ Controller. The basic frame formats are shown below.

**Note** Host Link communications handle ASCII data, so data is sent and received in ASCII. For that reason, FINS command and response frames must also be sent and received in ASCII when they are handled using Host Link communications.

#### Command Frame

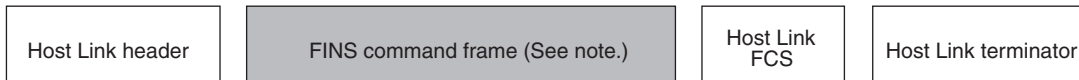

**Note** A FINS command frame also consists of the destination node address, the source node address, and other FINS command format data.

The CS/CJ/CP-series CPU Unit or NSJ Controller that receives the command will return the following response frame to the host computer.

#### Response Frame

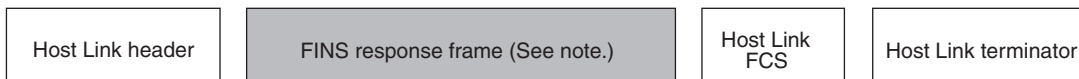

**Note** A FINS response frame also consists of the contents set (e.g., requested) at the time of transmission and the FINS command response format data.

It is also possible to send a FINS command frame with a Host Link header and terminator from a CS/CJ/CP-series (not possible from a CP1E CPU unit) CPU Unit or NSJ Controller to a host computer connected by Host Link System (unsolicited communications initiated by a slave).

## 3-3 FINS Command and Response Frames

If the data from the command code onwards is set in the words specified with S when a FINS command is sent by means of CMND(490), a FINS header will be generated automatically and attached, and the FINS command frame will be sent. When the FINS response frame is received, the FINS header will be automatically removed and the response data from the command code onwards will be stored as specified in the words specified with operand D.

When a FINS command is sent by Host Link communications, the header is attached before the FINS frame, and the FCS and terminator are attached after it.

### 3-3-1 FINS Command Frame Configuration

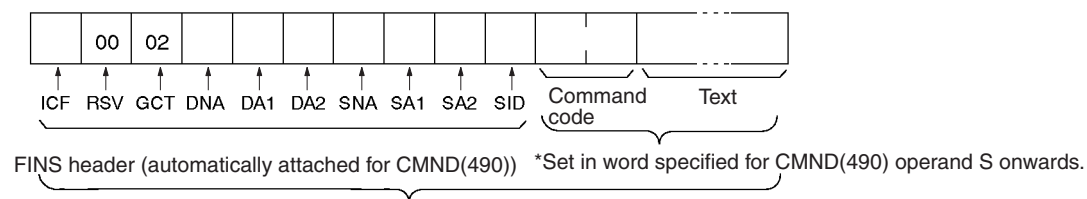

\*With Host Link communications, the header, FCS, and terminator are attached before and after the frame.

### 3-3-2 FINS Response Frame Configuration

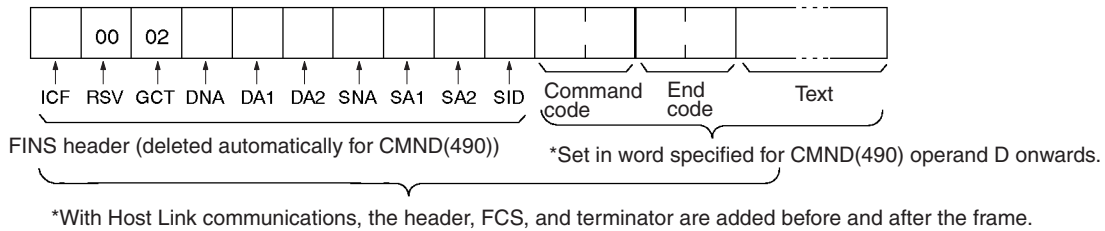

### 3-3-3 Individual Items in Command/Response Frames

#### ICF

The ICF (Information Control Field) is configured as shown in the following diagram.

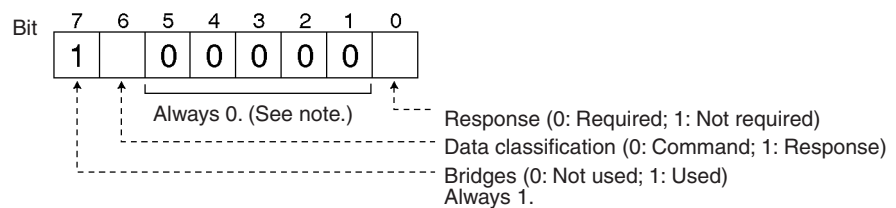

**Note** Set bits 01 to 05 to 0 when sending a FINS command. Do not access these bits when receiving a FINS response.

#### RSV

RSV (Reserved) is always 00 hex. These bits are used by the system. Do not access them in the response.

#### GCT

When communicating across up to 8 network layers with CS1-H CPU Units, CJ1-H CPU Units, CJ1M CPU Units, and CS1D CPU Units (for Single CPU Systems) with unit version 2.0 or later, set the GCT (Gateway Count: Number of Bridges Passed Through) to 07 hex when sending a FINS command. Otherwise, set the GCT to 02 hex (see note) when sending. When receiving a FINS response, GCT is decremented one for each bridge (network) that is passed through and the resulting value is received. This value is for system use; do not access it.

**Note** For CS1-H CPU Units, CJ1-H CPU Units, CJ1M CPU Units, CS1D CPU Units (for Single CPU Systems) with unit version 2.0 or later, CP-series CPU Units, or NSJ Controllers, CX-Programmer version 4.0 or later can be used to set routing tables that start the GCT at 07 Hex. For CS1-H CPU Units, CJ1-H CPU Units, CJ1M CPU Units with unit version 3.0 or later, CS1D CPU Units (for Single CPU Systems) with unit version 4.0 or later, CX-Programmer (CX-Net) Ver. 5.0 or higher can be used to set routing tables that start the GCT at either 07 Hex or 02 Hex. For details, refer to *1-4-2 Communications through a Maximum of 8 Network Levels* in the *CS Series PLC Operation Manual* or the *CJ Series PLC Operation Manual*.

#### DNA

Destination network address. Specify within the following ranges (hex).

- 00: Local network
- 01 to 7F: Remote network address (decimal: 1 to 127)

#### DA1

Destination node address. Specify within the following ranges (hex).

- 00: Internal communications in local PLC
- 01 to 20: Node address in Controller Link Network (1 to 32 decimal)
- 01 to FE: Ethernet (1 to 254 decimal,  
for Ethernet Units with model numbers ending in ETN21)
- FF: Broadcast transmission

**DA2**

Destination unit address. Specify within the following ranges (hex).

- 00: CPU Unit
- FE: Controller Link Unit or Ethernet Unit connected to network
- 10 to 1F: CPU Bus Unit
- E1: Inner Board

**SNA**

Source network address. Specify within the following ranges (hex).

- 00: Local network
- 01 to 7F: Remote network (1 to 127 decimal)

**SA1**

Source node address. Specify within the following ranges (hex).

- 00: Internal communications in PLC
- 01 to 20: Node address in Controller Link Network (1 to 32 decimal)
- 01 to FE: Ethernet (1 to 254 decimal,  
for Ethernet Units with model numbers ending in ETN21)

**SA2**

Source unit address. Specify within the following ranges (hex).

- 00: CPU Unit
- 10 to 1F: CPU Bus Unit

**SID**

Service ID. Used to identify the process generating the transmission. Set the SID to any number between 00 and FF

- Note**
1. The unit address for a CPU Bus Unit is 10 (hexadecimal) plus the unit number set on the front panel of the CPU Bus Unit.
  2. With CS1-H CPU Units, CJ1-H CPU Units, CJ1M CPU Units, CS1D CPU Units (for Single CPU Systems) with unit version 2.0 or later, CP-series CPU Units, or NSJ Controllers, the GCT (Gateway Count: Number of Bridges Passed Through) in FINS command/response frames is decremented from 07 hex (variable). The GCT was previously decremented from 02 hex. For CS/CJ-series CPU Unit with unit version 3.0 or later, the GCT (Gateway Count: Number of Bridges Passed Through) in FINS command/response frames is decremented from 02 hex by default. If the user specified CX-Net for this CPU Unit version, the GCT will be decremented from 07 hex. With a CS1-H CPU Units, CJ1-H CPU Units, CJ1M CPU Units with unit version 3.0 or later, CS1D CPU Units (for Single CPU Systems) with unit version 4.0 or later, NSJ Controllers, or CP-series CPU Units, the GCT will be decremented from 02 hex by default and from 07 hex if the user selects CX-Net.
  3. The GCT (Gateway Count: Number of Bridges Passed Through) in the FINS header in FINS command/response frames should not be checked in the user applications, e.g., in the host computer. The GCT is for system use only and verification may fail if attempted from a user application. This is particularly important for CS1-H CPU Units, CJ1-H CPU Units, CJ1M CPU Units, CS1D CPU Units (for Single CPU Systems) with unit version 2.0 or later, CP-series CPU Units, or NSJ Controllers.



### 3-4 Settings for Sending FINS Commands

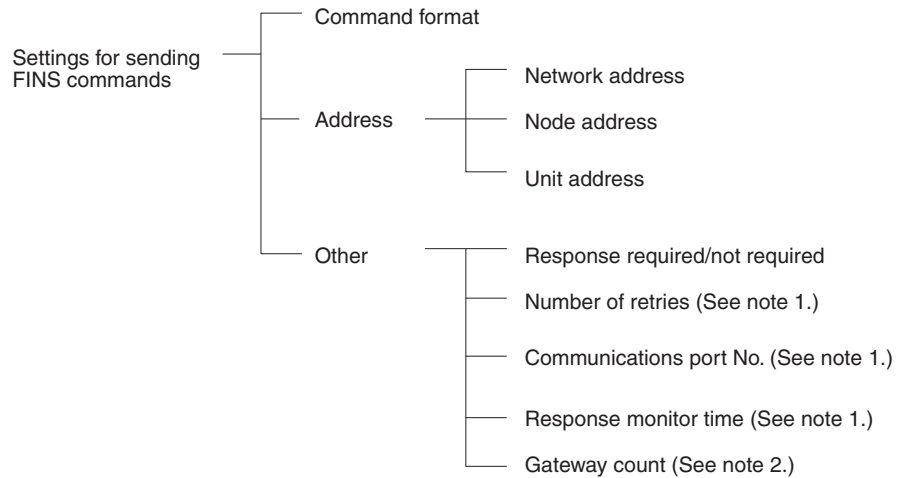

- Note**
1. Set these as operands when executing CMND(490).
  2. Do not set the gateway count when using CMND(490).

#### 3-4-1 FINS Command and Response Formats

##### Command Format

As shown below, the command format basically consists of the command code (four digits hexadecimal) and parameters (text).

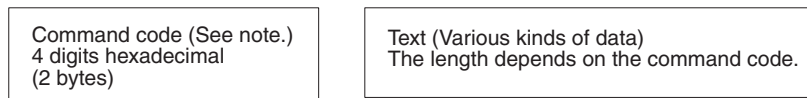

**Note** The command code is a 2-byte code that expresses the content of the command. A FINS command must begin with a 2-byte command code. If there is also text, it is added after the command code.

##### Example: Command for Reading I/O Memory

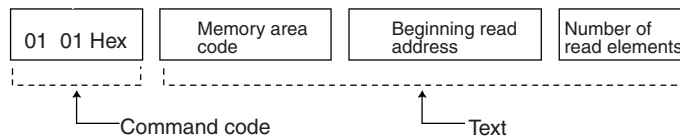

The following data would read 10 words starting from D00010.

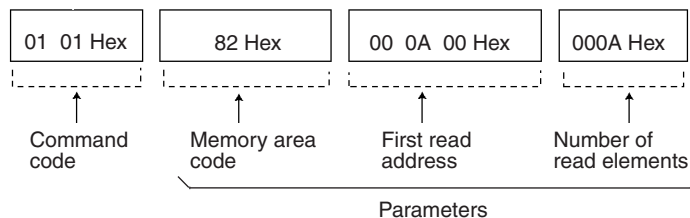

##### Response Format

As shown below, the response format basically consists of the command code (four digits hexadecimal), end code, and parameters (text).

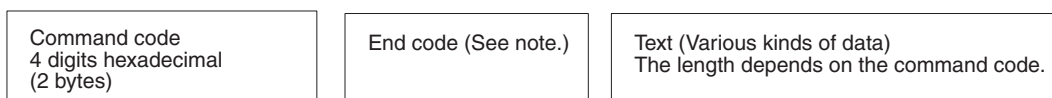

**Note** The end code is a 2-byte code that shows the command execution result. (The first byte shows the general category, and the second byte shows the detailed results.)

**Example: Response from Reading I/O Memory**

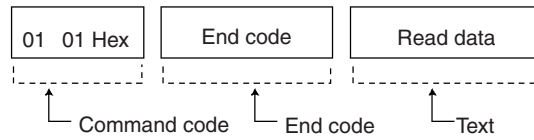

Actual response data would be as follows:

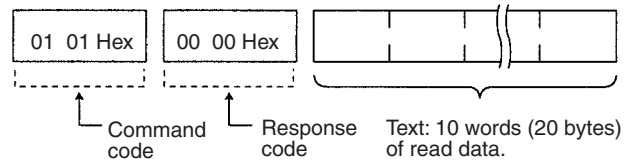

**3-4-2 Addresses in FINS Commands**

FINS commands are transmitted across networks and to various devices (via network nodes). Designate the addresses as follows:

- Designate the device from which the command is to be sent, the network that the device is on, and the node through which the command is to transit.
- Designate the device to which the command is to be sent, the network the device is on, and the node through which command is to transit.

Addresses must be provided for the network, node, and device (unit) to identify them. FINS commands include these addresses (the transmission source and destination addresses) in the command/response frames.

Addresses for FINS Commands

| Address         | Values  | Designation method            |  |
|-----------------|---|-------------------------------|--|
|                 |   | CMND(490) operand designation | Designation in frame when frame is created |
| Network address | 1 to 127 (01 to 7F Hex)<br>Local node address: 00 Hex   | Yes                           | Yes  |
| Node address    | 1 to 254 (01 to FE Hex) (See note.)<br><b>Note</b> The node addresses differ for each network.<br>Internal Communications in PLC: 00 Hex<br>For Controller Link: 01 to 3E Hex (1 to 62)<br>For Ethernet Units with model numbers ending in ETN21: 01 to FE Hex (1 to 254)<br>For Ethernet Units with other model numbers: 01 to 7E Hex (1 to 126) | Yes                           | Yes  |
| Unit address    | <ul style="list-style-type: none"> <li>•CPU Unit: 00 Hex</li> <li>•CPU Bus Unit: Unit No.+ 10 Hex</li> <li>•Special I/O Unit: Unit No.+ 20 Hex</li> <li>•Inner Board: E1 Hex</li> <li>•Computer: 01 Hex</li> <li>•Unit connected to network: FE Hex</li> </ul>  | Yes                           | Yes  |

Devices on the Same Network

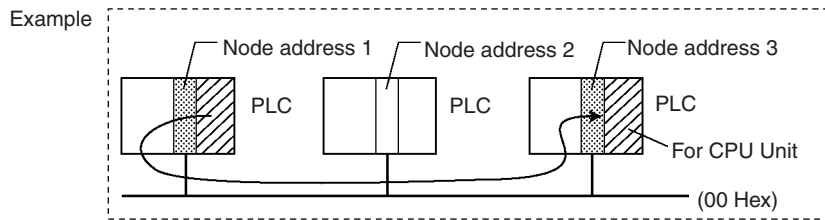

| Address         | Source address (See note 1.) |               | Destination address (See note 2.) |               |
|-----------------|------------------------------|---------------|-----------------------------------|---------------|
|                 | FINS command symbol          | Example value | FINS command symbol               | Example value |
| Network address | SNA                          | 00 Hex        | DNA                               | 00 Hex        |
| Node address    | SA1                          | 01 Hex        | DA1                               | 03 Hex        |
| Unit address    | SA2                          | 00 Hex        | DA2                               | 00 Hex        |

- Note**
1. The transmission source address will be automatically incorporated into the frame if the FINS command is sent with CMND(490). If sending the FINS command by Host Link communications, then put the source address in the message.
  2. Set the transmission destination address in the control code (C) operand if sending the FINS command with CMND(490). If sending the FINS command by Host Link communications, then put the destination address in the message.

Devices on Different Networks

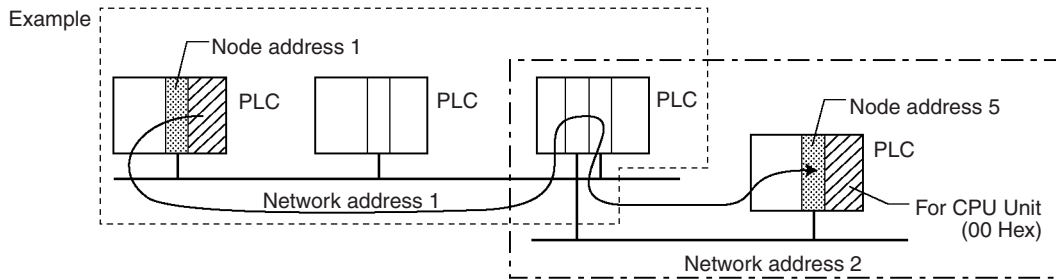

| Address level   | Source address (See note 1.) |               | Destination address (See note 2.) |               |
|-----------------|------------------------------|---------------|-----------------------------------|---------------|
|                 | FINS command symbol          | Example value | FINS command symbol               | Example value |
| Network address | SNA                          | 01 Hex        | DNA                               | 02 Hex        |
| Node address    | SA1                          | 01 Hex        | DA1                               | 05 Hex        |
| Unit address    | SA2                          | 00 Hex        | DA2                               | 00 Hex        |

- Note**
1. The transmission source address will be automatically incorporated into the frame if the FINS command is sent with CMND(490). If sending the FINS command by Host Link communications, then put the source address in the message.
  2. Set the transmission destination address in the control code (C) operand if sending the FINS command with CMND(490). If sending the FINS command by Host Link communications, then put the destination address in the message.

Unit Addresses

Set the unit address for the following purposes:

- To identify the Unit when there is more than one device connected at the same node on a network.
- To identify the type of device (CPU Unit, CPU Bus Unit, etc.) at the destination.

**Note** The meanings of FINS commands will vary depending on the Unit at the destination even when the commands have the same command code. This is why the Unit at the destination must be identified by the unit address.

Unit addresses are as follows:

- CPU Unit: 00 Hex
- CPU Bus Unit: Unit number + 10 hex
- Special I/O Unit: Unit number + 20 hex
- Inner Board: E1 Hex (CS Series only)
- Computer: 01 Hex
- Communications Unit with the specified node address connected to network with the specified network address (Controller Link or Ethernet): FE Hex

| Unit address | 00 Hex | Unit No. + 10 Hex | E1 Hex | 01 Hex |
|--------------|--------|-------------------|--------|--------|
| Contents     |        |                   |        |        |

**Note** It is also possible to set the serial port (No. 1 to 4) for the destination device.

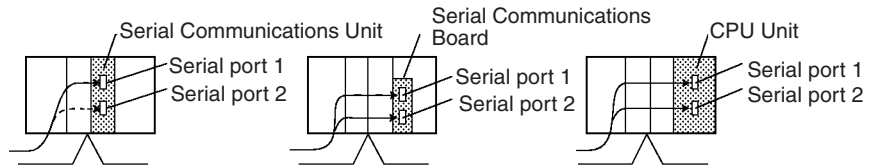

**Unit Addresses for Computers Connected to Serial Ports**

The unit addresses for host computers connected to a CS/CJ/CP/NSJ serial port (e.g., on a CPU Unit, Option Board, Serial Communications Unit, or Serial Communications Board) are shown in the following table.

| Unit/Board                                     | Peripheral port      | RS-232C port                                 |
|--|----------------------|--|
| CS/CJ-series CPU Unit                          | FD Hex (253 decimal) | FC Hex (252 decimal)                         |
| NSJ Controller                                 | ---                  | FC Hex (Serial port C on Controller Section) |
| Built-in serial ports of N-type CP1E CPU Units | ---                  | ---(See note.)                               |

| Unit/Board                                | Serial port 1                 | Serial port 2                 |
|---|-------------------------------|-------------------------------|
| CS/CJ -series Serial Communications Board | E4 Hex                        | E5 Hex                        |
| CS/CJ-series Serial Communications Unit   | 80 Hex + 04 Hex x unit number | 81 Hex + 04 Hex x unit number |
| CP-series Option Board (See Note.)        | FD Hex                        | FC Hex                        |

**Note** A FINS command to a host computer cannot be issued from a CP1E CPU unit.

For the SEND, RECV, and CMND instructions, the CPU Unit will add the proper unit address based on the unit address of the Unit/Board and the specified serial port. It is not necessary to consider these addresses in the ladder-diagram program.

**Unit Addresses for Serial Ports on Serial Communications Boards and Units**

The network address and serial port's unit address must be allocated and the routing table's local network table must be created for Several settings are required when making network settings (FINS command system settings) for serial communications through a serial port on a CS Series Serial Communications Board or CS/CJ Series Serial Communications Unit. The network address and the serial port's unit address (permanent) must be allocated and the routing table's local network table must be created. The following diagrams show serial port's unit address.

- Example 1: Serial Communications Board

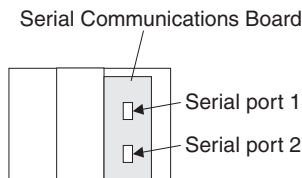

| Serial port on Board | Serial port's unit address |
|----------------------|----------------------------|
| Serial port 1        | E4 hex (228 decimal)       |
| Serial port 2        | E5 hex (229 decimal)       |

• Example 2: Serial Communications Unit

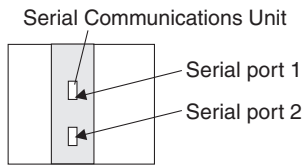

| Serial port on Unit | Serial port's unit address    | Example: Unit number 1                     |
|---------------------|-------------------------------|--|
| Serial port 1       | 80 hex + 04 hex × unit number | 80 hex + 04 hex × 1 = 84 hex (132 decimal) |
| Serial port 2       | 81 hex + 04 hex × unit number | 81 hex + 04 hex × 1 = 85 hex (132 decimal) |

Unit addresses for serial port 1:

| Unit number | 0   | 1   | 2   | 3   | 4   | 5   | 6   | 7   | 8   | 9   | A   | B   | C   | D   | E   | F   |
|-------------|-----|-----|-----|-----|-----|-----|-----|-----|-----|-----|-----|-----|-----|-----|-----|-----|
| Hexadecimal | 80  | 84  | 88  | 8C  | 90  | 94  | 98  | 9C  | A0  | A4  | A8  | AC  | B0  | B4  | B8  | BC  |
| Decimal     | 128 | 132 | 136 | 140 | 144 | 148 | 152 | 156 | 160 | 164 | 168 | 172 | 176 | 180 | 184 | 188 |

Unit addresses for serial port 2:

| Unit number | 0   | 1   | 2   | 3   | 4   | 5   | 6   | 7   | 8   | 9   | A   | B   | C   | D   | E   | F   |
|-------------|-----|-----|-----|-----|-----|-----|-----|-----|-----|-----|-----|-----|-----|-----|-----|-----|
| Hexadecimal | 81  | 85  | 89  | 8D  | 91  | 95  | 99  | 9D  | A1  | A5  | A9  | AD  | B1  | B5  | B9  | BD  |
| Decimal     | 129 | 133 | 137 | 141 | 145 | 149 | 153 | 157 | 161 | 165 | 169 | 173 | 177 | 181 | 185 | 189 |

**Summary of Addresses**

The three addresses used in FINS commands can be summarized as follows (refer to the following diagram):

**Network Address**

An address that identifies the entire network. All nodes on the same network have the same network address.

**Node Address**

An address that identifies an individual node on a network, such as a PLC or host computer.

**Unit Address**

For a PLC, an address that identifies the specific Unit that is participating in the communication in the PLC. For a host computer, an address that identifies the specific application that is participating in the communication in the computer.

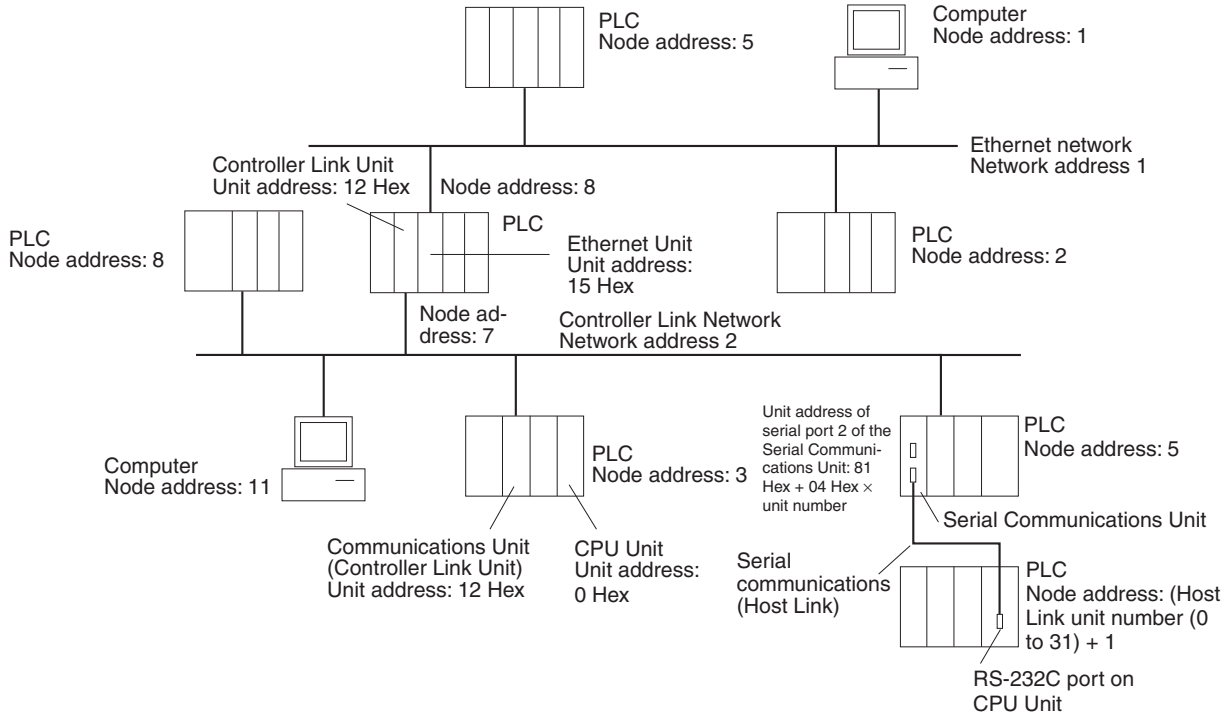

### 3-4-3 Other FINS Command Settings

Aside from the addresses, the following data must be set.

| Setting                                     | Content  | Values   | Designation method            |  |
|---|--|--|-------------------------------|--|
|   |  |  | CMND(490) operand designation | Designation in frame when frame is created |
| Number of retries                           | Number of times to retry sending the command.  | 0 to F Hex (0 to 15 times)   | Yes                           | No   |
| Port No.                                    | Logical communications port. CS/CJ/CP-series CPU Units have 8 communications ports, so 8 communications commands can be executed simultaneously. To execute 9 or more commands, simultaneously, it is necessary to set up exclusive control. | 0 to 7 Hex   | Yes                           | No   |
| Serial port No.                             | Specifies the number of the serial port of the Unit with Host Link capabilities.   | 0: Unit/Board<br>1: Serial port 1 for Serial Communications Board/Unit or Peripheral port for CPU Unit<br>2: Serial port 2 for Serial Communications Board/Unit or RS-232C port for CPU Unit | Yes                           | No   |
| Response monitor time                       | Monitors the time it takes to return a response. If a response is not returned within the designated time, a response timeout is generated.  | 0001 to FFFF Hex (0.1 to 6,553.5 seconds)  | Yes                           | No   |
| Response required/ not required (ICF bit 0) | Designates whether or not a response is required.  | 0 or 1 (bit)   | Yes                           | Yes  |
| Gateway count                               | Designates the number of networks that can be accessed.  | 00 to 07 Hex   | No                            | Yes  |

- Note**
- Unit address are fixed for Units and Boards, as well as for serial ports. For the SEND(090), RECV(098), and CMND(490) instructions, the CPU Unit will add the proper unit address based on the unit address of the Unit/Board and the specified serial port. It is not necessary to consider these addresses in the ladder-diagram program.  
 Serial Port 1:  
 80 Hex + 04 Hex x unit number for Serial Communications Units, E4 Hex for Serial Communications Boards, and FC Hex (CPU Unit's RS-232C or serial port 2 on CP1H Option Board)  
 Serial Port 2:  
 81 Hex + 04 Hex x unit number for Serial Communications Units, E5 Hex for Serial Communications Boards, and FD Hex (CPU Units peripheral port or serial port 1 on CP1H Option Board)
  - The gateway count is decremented one for each bridge (network) that is passed through.





### 3-5 FINS Commands with Host Link Protocol

FINS commands can be sent and received using the Host Link protocol between interconnected host computers and PLCs.

#### 3-5-1 Connection Configurations

One of the following two methods can be used to send and receive FINS commands using the Host Link protocol.

##### Sending from a Computer to a CPU Unit

**Note** The host computer can be connected to the peripheral port or RS-232C port on the CPU Unit or to a serial ports on a Serial Communications Unit/Board. The Host Link protocol must be used regardless of the point of connection.

##### CPU Unit Directly Connected to Host Computer

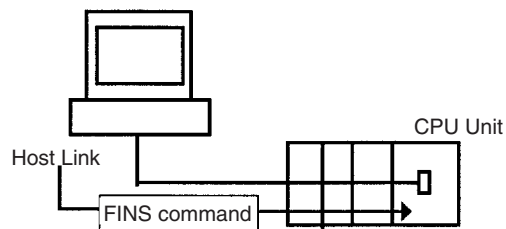

##### CPU Units on a Network

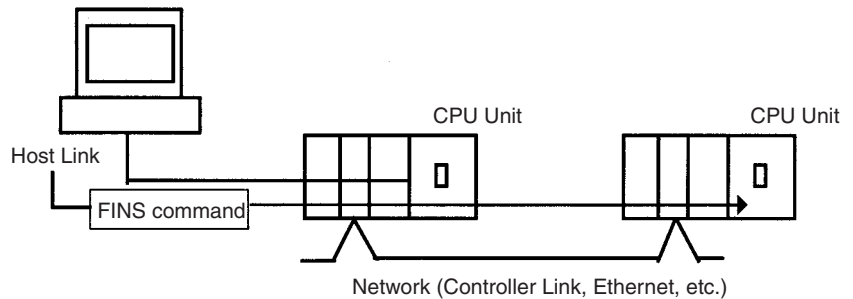

##### Sending from a CPU Unit to a Computer (Slave Initiation)

- Note**
1. Slave initiation is not possible from a CP1E CPU.
  2. The host computer can be connected to the peripheral port or RS-232C port on the CPU Unit or to a serial ports on a Serial Communications Unit/Board. The Host Link protocol must be used regardless of the point of connection.

##### CPU Unit Directly Connected to Host Computer

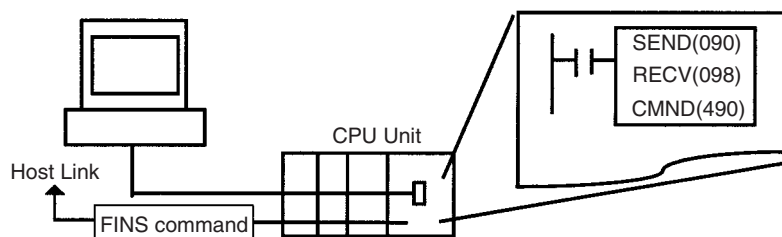

CPU Unit Directly Connected to Host Computer on a Network

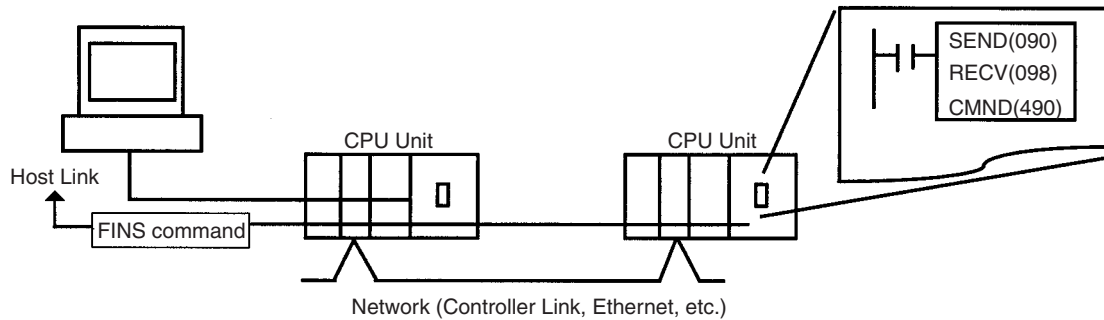

- Note**
1. Host Link communications handle ASCII data, so data is sent and received in ASCII. Hexadecimal values in FINS command and response frames must, therefore, also be sent and received in ASCII when they are handled using Host Link communications.
  2. When a FINS command sent from a host computer or the CPU Unit (with the CMND instruction) is received by a Serial Communications Board or Unit with version number Ver. 1.2 or later, that PLC acts as the Host Link Master and it can send the FINS command to a Slave PLC through the Host Link system.
  3. When the Ethernet option board (CP1W-CF41) is used, a FINS command cannot be issued to Host Link via the Ethernet option board.

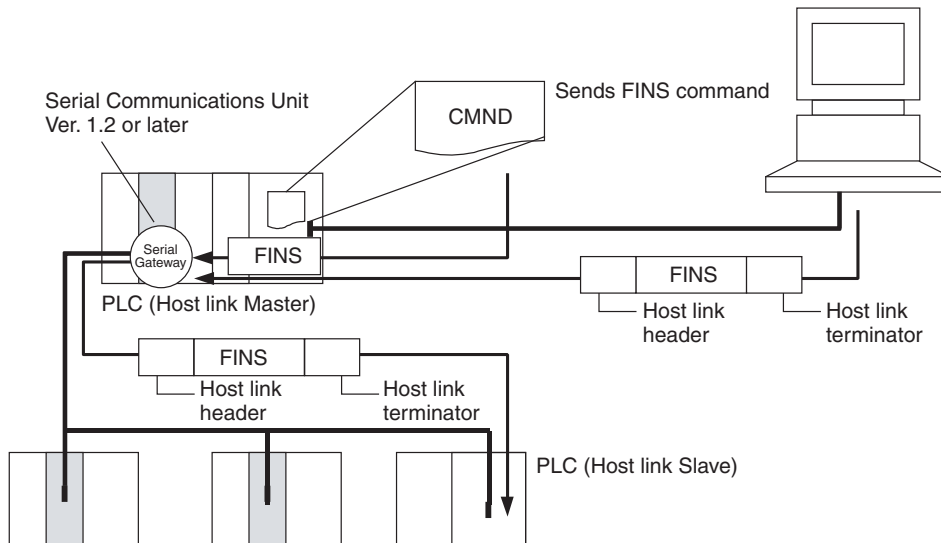

3-5-2 Overview of Command and Response Frames

When FINS commands and responses are sent or received using Host Link communications, the frame must be preceded by a Host Link header and followed by a Host Link FCS and terminator as shown below.

Command Frame

Use the following format to send FINS command frames.



**Note** A FINS command frame also consists of the response wait time, the destination node address, the source node address, and other FINS command format data.

**Response Frame** The CS/CJ/CP-series CPU Unit or NSJ Controller that receives the command will return the following response frame to the host computer.



**Note** A FINS response frame also consists of the contents set at the time of transmission and the FINS command response format data.

### 3-5-3 Sending Commands from the Computer to the CPU Unit

#### Command Format from Host Computer

Use the following command format to send FINS commands from the host computer to the CPU Unit.

**Note** The length of the command must be not more than 1,114 characters. FINS commands cannot be partitioned into separate frames for sending.

#### Sending Commands to a CPU Unit Directly Connected to the Host Computer

**Note** The following format is also applicable for a host computer connected to a Serial Communications Board or a Serial Communications Unit.

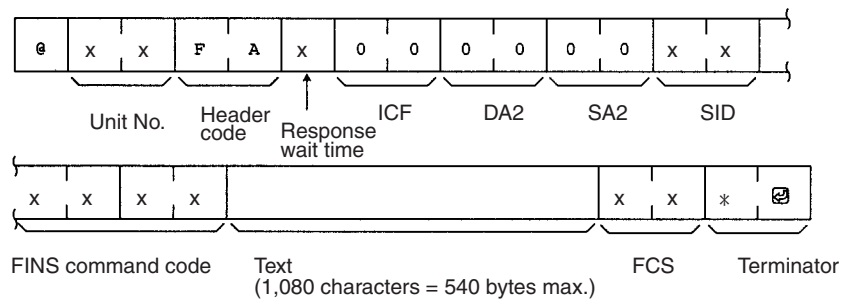

#### Sending Commands to a CPU Unit on a Network

**Note** The following format can also be used to send FINS commands to a CPU Unit connected to the host computer.

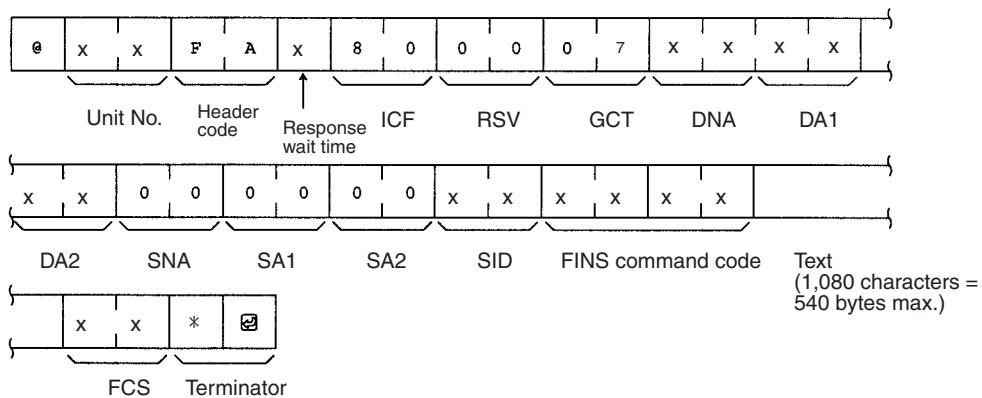

#### Host Link Settings

**@** The @ symbol must be attached to the beginning of the command.

#### Unit Number

The unit number set is that of the destination CPU Unit connected to the host

computer. When the host computer is connected to a CPU Unit, the unit number is designated in the PLC Setup.

When the host computer is connected to a Serial Communications Board or a Serial Communications Unit, the unit number is the designated in the Setup for the Board or Unit.

**Header Code**

The header code distinguishes between different types of commands. Set “FA” (ASCII: 46, 41) when using FINS commands.

**Response Wait Time**

The response wait time sets the time from when the CPU Unit receives a command block until it starts to return a response. It can be set from 0 to F in hexadecimal, in units of 10 ms.

Example:

If F(15) is set, the response will begin to be returned 150 ms (15 × 10 ms) after the command block was received.

**ICF (Information Control Field)**

Specifies whether or not there are network relays. Set “80” (ASCII: 38,30) when sending an FINS command to a CPU Unit on a network. Set “00” (ASCII: 30,30) when sending to a CPU Unit connected directly to the host computer.

**RSV (Reserved)**

Set “00” (ASCII: 30,30). Setting RSV is required only when sending to a CPU Unit on a network.

**GCT (Gateway Count)**

This is the number of networks through which the transmission can be relayed. Set “07” (ASCII: 30, 37). Setting GCT is required only when sending to a CPU Unit on a network.

**DNA, DA1, DA2**

Set the destination network, node, and unit addresses.

**DNA (Destination Network Address)**

Set between 00 and 7F Hex (0 and 127 decimal). Setting DNA is required only when sending to a CPU Unit on a network.

**DA1 (Destination Node Address)**

Set within the following ranges. Setting DA1 is required only when sending to a CPU Unit on a network.

Ethernet Units with model numbers ending in ETN21:  
01 to FE hex (1 to 254)

Ethernet Units with other model numbers:  
01 to 7E hex (1 to 126)

Controller Link Unit: 01 to 20 hex (1 to 32 decimal)

SYSMAC NET: 01 to 7E hex (1 to 126 decimal)

SYSMAC LINK: 01 to 3E hex (1 to 62 decimal)

**DA2 (Destination Unit Address)**

Refer to *3-4-2 Addresses in FINS Commands* for details on unit addresses.

In Host Link mode, it is assumed that the destination unit is the CPU Unit, so set “00” (ASCII: 30, 30).

**SNA (Source Network Address), SA1 (Source Node Address)**

Set the source network and node addresses. Set both to “00” (ASCII: 30, 30) regardless of whether or not there is a network relay.

Setting SNA and SN1 is required only when sending to a CPU Unit on a network.

**SA2 (Source Unit Address)**

Set the unit address of the Unit physically connected to the host computer. The setting changes depending on the connected Unit.

When connected to the CPU Unit, Serial Communications Board, or a Serial Communications Unit, set "00" to indicate the CPU Unit (ASCII: 30, 30).

**SID (Source ID)**

The SID is used as a counter when resending. It should normally be set to "00" (ASCII: 30, 30).

**Command Code, Text**

Set the command code and text according to the FINS command and response formats.

**FCS (Frame Check Sequence)**

Set a 2-character FCS. Refer to *FCS Calculations* under *2-2 Command/Response Formats* for the FCS calculation method.

**Terminator**

The terminator is a required delimiter at the end of a command. Set the terminator to \*CR (ASCII: 2A, 0D).

**Response Format from a CPU Unit**

The following response format is used to return responses from the CPU Unit to the host computer.

**Note** The length of the response must be not more than 1,115 characters. Of this, the response data without the response code is 1,076 characters (538 bytes).

**Responses from a CPU Unit Directly Connected to the Host Computer**

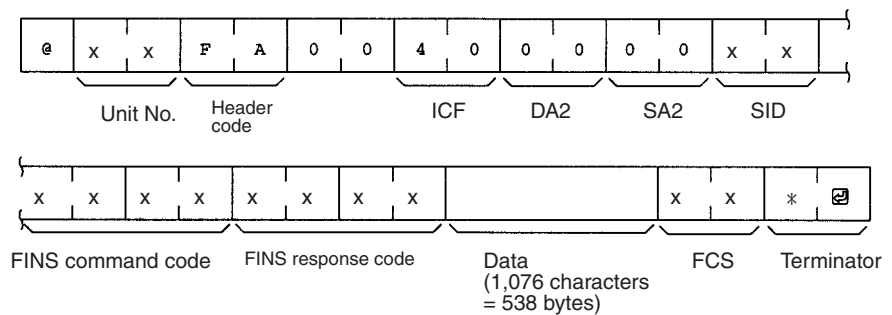

**Responses from a CPU Unit on a Network**

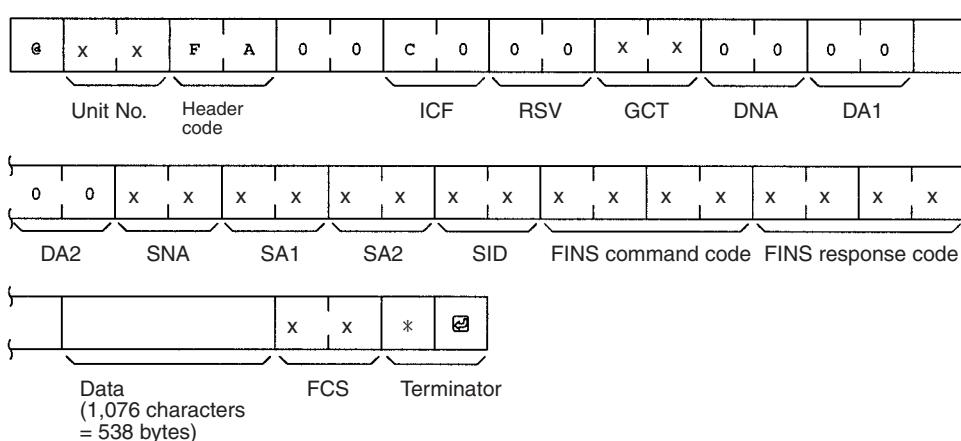

## Host Link Settings

**@**

The @ symbol must be attached to the beginning of the response.

**Unit Number and Header Code**

The same unit number and header code specified in the FINS command that was received will be returned.

**ICF (Information Control Field)**

For a CPU Unit on a network, "C0" (ASCII: 43, 30) will be returned. For a CPU Unit connected directly to the host computer, "40" (ASCII: 34,30) will be returned.

**RSV (Reserved)**

This section is reserved for the system. Do not access the RSV.

**GCT (Gateway Count)**

This section is reserved for the system. Do not access the GCT. The same GCT that was specified in the command that was received will be returned. Setting GCT is required in the response format only from a CPU Unit on a network.

**DNA (Destination Network Address), DA1 (Destination Node Address), DA2 (Destination Unit Address)**

The same contents specified for SNA, SA1, and SA2 in the command that was received will be returned.

Setting DNA and DA1 is required for response formats only from a CPU Unit on a network.

**SNA (Source Network Address), SA1 (Source Node Address), SA2 (Source Unit Address)**

The same contents specified for DNA, DA1, and DA2 in the command that was received will be returned.

Setting SNA and SN1 is required for response formats only from a CPU Unit on a network.

**SID (Source ID)**

The SID that was specified in the command that was received will be returned.

**Command Code, Response Code, Text**

The command code, response code, and text corresponding to the FINS command and response formats will be returned.

**FCS (Frame Check Sequence)**

A 2-character FCS will be returned. Refer to *FCS Calculations* under *2-2 Command/Response Formats* for the FCS calculation method.

**Terminator**

The terminator is a required delimiter at the end of a command. The terminator \*CR (ASCII: 2A, 0D) will be returned.

**Example: FINS Command Settings for Sending to CPU Unit on a Network**

With Host Link communications, FINS command transmissions and receptions are handled in ASCII, so hexadecimal values in FINS command frames must be sent as ASCII. For example, the hexadecimal value "0" would be "30 Hex" in ASCII, and the hexadecimal value "A" would be "41 Hex" in ASCII.

The destination network address, node address, and unit number address are explained using the following network as an example.

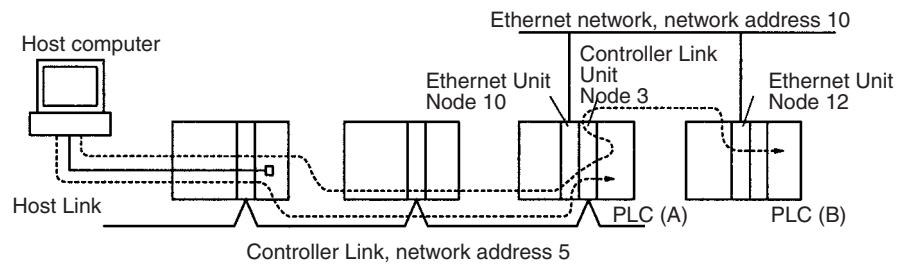

**Sending a Command from a Host Computer to PLC (A)**

The following addresses are specified to the CPU Unit at network address 5, node address 3:

- Destination network address (DNA): 05 (30, 35)
  - Destination node address (DA1): 03 (30, 33)
  - Destination unit address (DA2): 00 (30, 30)
- (Command addressed to CPU Unit)

**Sending a Command from a Host Computer to PLC (B)**

The following addresses are specified to the CPU Unit at network address 10, node address 12:

- Destination network address (DNA): 0A (30, 41)
  - Destination node address (DA1): 0C (30, 43)
  - Destination unit address (DA2): 00 (30, 30)
- (Command addressed to CPU Unit)

**3-5-4 Sending FINS Commands to the Host Computer from the CPU Unit**

With normal Host Link communications, FINS commands are sent from the host computer to the CPU Unit. Commands can also be sent, however, from the CPU Unit to the host computer. Any FINS command can be sent to the host computer using SEND(090), which sends CPU Unit data to the host computer, RECV(098), which receives data from the host computer, or CMND(490).

Slave-initiated communications allows the host computer to be notified (unsolicited communications) when an error is generated, for example, on a production line controlled by a CPU Unit. Since the host computer no longer needs to regularly communicate with the CPU Unit, the load on the host computer is reduced.

When an Ethernet Unit or Controller Link Unit are mounted to the Backplane of the CPU Unit, commands can be sent to the host computer from a CPU Unit on a network on another level (up to three network levels).

**Note** In principle, send commands to the host computer only when one host computer is connected to one CPU Unit. If more than one CPU Unit is connected to the host computer, the commands may collide with each other and prevent normal communications. Create a program that will exclusively control commands that are being sent to a host computer to which multiple CPU Units are connected.

**Considerations when Sending Commands from a CPU Unit**

Consider the following items when using instructions (SEND(090), RECV(098), and CMND (490)) to send commands from the CPU Unit.



- 1,2,3...
1. SEND(090), RECV(098), and CMND (490) executed by the CPU Unit are converted to the same format for FINS commands that are sent to CPU Units on networks.
  2. A program must be created to process the commands received by the host computer.
  3. When instructions (SEND(090), RECV(098), and CMND (490)) are executed in a CPU Unit, some of the control data settings will be different. Refer to the relevant instruction specifications.

### 3-5-5 Sending Commands from the CPU Unit

When controls are being implemented by sending commands from the local CPU Unit or another CPU Unit on a network to a host computer, three instructions can be used in the user program: SEND(090), RECV(098), and CMND(490).

#### Send(090)

Memory area data can be sent from the CPU Unit to the host computer by using SEND(090).

#### Command Format Received by the Host Computer

The FINS command transmitted to the host computer when SEND(090) is executed is MEMORY AREA WRITE (command code 0102). The command format received by the host computer is as shown in the following diagram. Refer to MEMORY AREA WRITE: 0102 in Section 5 FINS Commands for details.

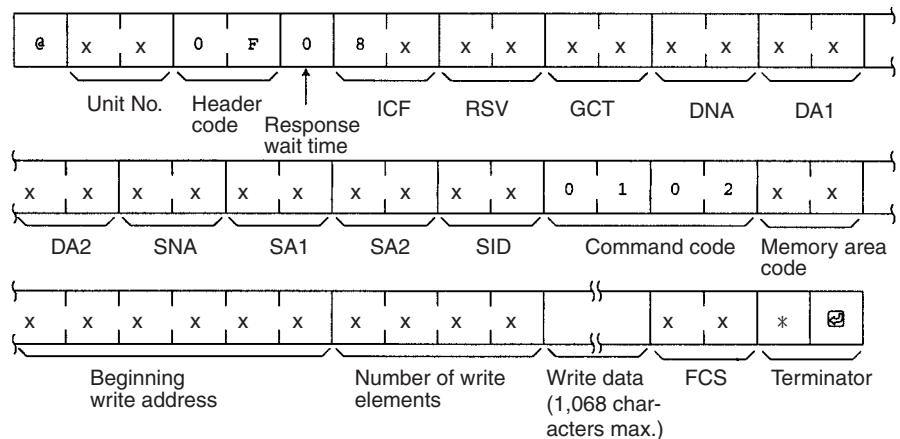

#### Control Words

Control data must be set before SEND(090) is executed. The control data is written in the following format, starting from the first control word.

| Word | Bits 00 to 07                       | Bits 08 to 15  |
|------|-------------------------------------|--|
| C    | Number of send words                |  |
| C+1  | Destination network address         | Bits 08 to 10: Serial port number                            |
| C+2  | Destination unit address            | Destination node address                                     |
| C+3  | Bits 00 to 03: No. of retries       | Bits 08 to 10: Comm. port number<br>Bit 15: Response setting |
| C+4  | Response monitor time (unit: 0.1 s) |  |

#### Number of Send Words

Set the total number of words of data to be transferred to the host computer.

**Serial Port Number**

Set the serial port number to which the host computer is connected.

**Destination Network Address**

Set the network address of the destination node. Set “00” to send communications within the local network.

**Destination Node Address**

Set the node address of the destination node. Set “00” when transmitting within the local PLC.

**Destination Unit Address**

Set the unit address of the Unit to which the host computer is connected.

**Response Setting**

Normally this bit is set to 0 to require a response. When a response is not required, set this bit to 1.

**Communications Port Number**

Set the port number in the CPU Unit which will transmit SEND(090).

**Number of Retries**

Set the maximum number of times SEND(090) is to be resent if no response is returned.

**Response Monitor Time**

If the Response Setting is set to require a response, set the response monitor time.

**Control Word Settings**

The setting range for each item is shown on the following table.

| <b>Item</b>                 | <b>Setting</b>   |
|-----------------------------|--|
| Number of send words        | 0001 to 010B (1 to 267 words)  |
| Serial port number          | 00: Do not set.<br>01: Port 1<br>02: Port 2  |
| Destination network address | 00: Local network<br>01 to 7F: Network address (1 to 127)  |
| Destination node address    | 00: Internal communications in PLC<br>01 to FE: Node address of Ethernet Unit with model number ending in ETN21 (1 to 254)<br>01 to 7E: Node address of Ethernet Unit with other model number (1 to 126)<br>01 to 20: Node address (1 to 32) for Controller Link |
| Destination unit address    | 00: CPU Unit<br>10 to 1F: Serial Communications Unit (unit address 0 to 15)<br>E1: Inner Board (Serial Communications Board)   |
| Response setting            | 0: Required<br>1: Not required   |
| Communications port number  | 0 to 7 (0 to 7)  |
| Number of retries           | 0 to F (0 to 15)   |
| Response monitor time       | 0000: Default<br>0001 to FFFF: 0.1 to 6,553.5 s (unit 0.1 s)   |

**Note** To execute SEND(090) normally, programming needs to be written to process the data received by the host computer and return the proper response.

**RECV(098)**

By using RECV(098), data from the host computer can be written to a memory area in the CPU Unit.

**Command Format Received by the Host Computer**

The FINS command transmitted to the host computer when RECV(098) is executed is MEMORY AREA READ (command code 0101). The command format received by the host computer is shown in the following diagram.

Refer to *MEMORY AREA READ: 0101* in *Section 5 FINS Commands* for details

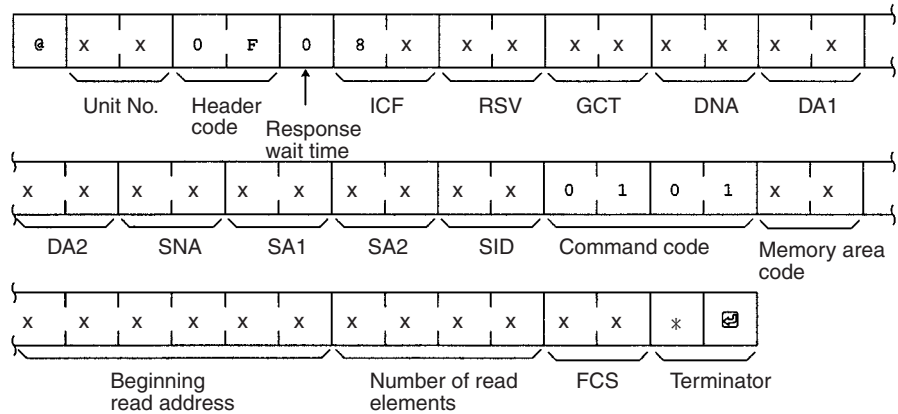

**Control Words**

Control data must be set before RECV(098) is executed. The control data is written in the following format, starting from the first control word.

| Word | Bits 00 to 07                       | Bits 08 to 15                     |
|------|-------------------------------------|-----------------------------------|
| C    | Number of read words                |                                   |
| C+1  | Destination network address         | Bits 08 to 10: Serial port number |
| C+2  | Destination unit address            | Destination node address          |
| C+3  | Bits 00 to 03: No. of retries       | Bits 08 to 10: Comm. port number  |
| C+4  | Response monitor time (unit: 0.1 s) |                                   |

**Number of Read Words**

Set the total number of words of data to be read from the host computer.

**Serial Port Number**

Set the serial port number to which the host computer is connected.

**Destination Network Address**

Set the network address of the destination node (i.e., the computer). Set "00" to send communications within the local network.

**Destination Node Address**

Set the node address of the destination node (i.e., the computer). Set "00" when transmitting within the local PLC.

**Destination Unit Address**

Set the unit address of the Unit to which the host computer is connected.

**Communications Port Number**

Set the port number in the CPU Unit which will transmit RECV(098).

**Number of Retries**

Set the maximum number of times RECV(098) is to be resent if no response is returned.

**Response Monitor Time**

Set the time to wait for a response

**Control Word Settings**

The setting range for each item is shown on the following table.

| Item                           | Setting  |
|--------------------------------|--|
| Number of read words           | 0001 to 010D (1 to 269 words)  |
| Serial port number             | 00: CPU Unit, Inner Board, CPU Bus Unit<br>01: Port 1<br>02: Port 2  |
| Destination network address    | 00: Local network<br>01 to 7F: Network address (1 to 127)  |
| Destination node address       | 00: Internal communications in PLC<br>01 to FE: Node address of Ethernet Unit with model number ending in ETN21 (1 to 254)<br>01 to 7E: Node address of Ethernet Unit with other model number (1 to 126)<br>01 to 3E: Node address (1 to 62) for Controller Link |
| Destination unit address       | 00: CPU Unit<br>10 to 1F: Serial Communications Unit (unit address 0 to 15)<br>E1: Inner Board (Serial Communications Board)   |
| Response required/not required | 0: Response required<br>1: Response not required   |
| Communications port number     | 0 to 7 (0 to 7)  |
| Number of retries              | 0 to F (0 to 15)   |
| Response monitor time          | 0000: Default<br>0001 to FFFF: 0.1 to 6,553.5 s (unit 0.1 s)   |

**Note** To execute RECV(098) normally, programming needs to be written to process the command received by the host computer and return the proper data.

**CMND(490)**

By using CMND(490), controls can be implemented by sending FINS commands to the host computer.

**Command Format Received by the Host Computer**

CMND(490) can be used to send any FINS command to the host computer. The command format received by the host computer is shown in the following diagram.

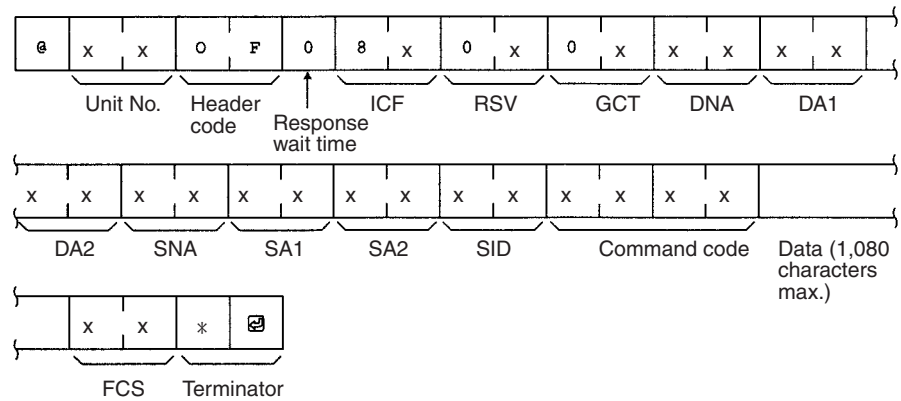

**Control Words**

Control data must be set before CMND(490) is executed. The control data is written in the following format, starting from the first control word.

| Word | Bits 00 to 07                    | Bits 08 to 15   |
|------|----------------------------------|---|
| C    | Number of bytes of command data  |   |
| C+1  | Number of bytes of response data |   |
| C+2  | Destination network address      | Bits 08 to 10: Serial port number                             |
| C+3  | Destination unit address         | Destination node address                                      |
| C+4  | Bits 00 to 03: No. of retries    | Bits 08 to 10: Comm. port number<br>Bits 15: Response setting |
| C+5  | Response monitor time            |   |

**Number of Bytes of Command Data**

Set the number of bytes of command data (including the command code) that are stored from the first command word

**Number of Bytes of Response Data**

Set the number of bytes of response data (including command code and end code) that are stored from the first response word.

**Serial Port Number**

Set the serial port number to which the host computer is connected.

**Destination Network Address**

Set the network address of the destination node (i.e., the computer). Set "00" to send communications within the local network.

**Destination Node Address**

Set the node address of the destination node (i.e., the computer). Set "00" when transmitting within the local PLC.

**Destination Unit Address**

Set the unit address of the Unit to which the host computer is connected.

**Response Setting**

Normally this bit is set to 0 to require a response. When a response is not required, set this bit to 1.

**Communications Port Number**

Set the port number in the CPU Unit which will transmit CMND(490).

**Number of Retries**

Set the maximum number of times CMND(490) is to be resent if no response is returned.

**Response Monitor Time**

If the Response Setting is set to require a response, set the response monitor time.

**Note** If response data longer than that set in the Number of Bytes of Response Data is returned, all extra response data will not be stored. If response data shorter than that set in the Number of Bytes of Response Data is returned, the response data will be stored, and the remaining area will stay at its previous values.

**Control Word Settings**

The setting range for each item is shown on the following table.

| Item                             | Setting  |
|----------------------------------|--|
| Number of bytes of command data  | 0002 to 021E (2 to 542 bytes)  |
| Number of bytes of response data | 0002 to 021E (2 to 542 bytes)  |
| Serial port number               | 00: CPU Unit, Inner Board, CPU Bus Unit<br>01: Port 1<br>02: Port 2  |
| Destination network address      | 00: Local network<br>01 to 7F: Network address (1 to 127)  |
| Destination node address         | 00: Internal communications in PLC<br>01 to FE: Node address of Ethernet Unit with model number ending in ETN21 (1 to 254)<br>01 to 7E: Node address of Ethernet Unit with other model number (1 to 126)<br>01 to 3E: Node address (1 to 62) for Controller Link |
| Destination unit address         | 10 to 1F: Serial Communications Unit (unit address 0 to 15)  |
| Response setting                 | 0: Required<br>1: Not required   |
| Communications port number       | 0 to 7 (0 to 7)  |
| Number of retries                | 0 to F (0 to 15)   |
| Response monitor time            | 0000: Default (2 s)<br>0001 to FFFF: 0.1 to 6,553.5 s (unit: 0.1 s)  |

**Note** To execute CMND(490) normally, programming needs to be written to process the command received by the host computer and return the proper response.

**3-5-6 Command Format Received by the Host Computer**

FINS commands sent to the host computer are received at the host computer in the format shown below.

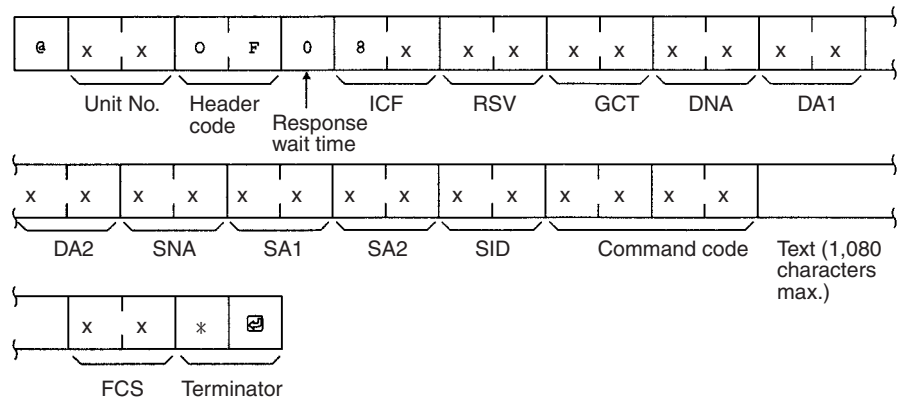

**Unit Number**

The unit number of the Host Link port connected to the host computer is set.

**Header Code**

The header code in FINS commands sent to the host computer is always set to "OF" (ASCII: 4F, 46).

**Response Wait Time**

The response wait time in FINS commands sent to the host computer is fixed at to "0" (ASCII: 4F, 46).

**ICF (Information Control Field)**

Specifies whether or not a response is required.

Response required: "80" (ASCII: 38,30)

Response not required: "81" (ASCII: 38,31)

**RSV (Reserved)**

Always set to "00" (ASCII: 30,30) in commands sent to the host computer.

**GCT (Gateway Count)**

The number of networks through which the command is relayed subtracted from 2 is set. (See note.)

Number of networks = 0: "02" (ASCII: 30, 32)

Number of networks = 1: "01" (ASCII: 30, 31)

Number of networks = 2: "00" (ASCII: 30, 30)

Number of networks = 7: "07" (ASCII: 30, 37)

**Note** The number of networks is subtracted from 7 for CS1-H CPU Units, CJ1-H CPU Units, CJ1M CPU Units, CS1D CPU Units (for Single CPU Systems) with unit version 2.0 or later, CP-series CPU Units, or NSJ Controllers.

**DNA, DA1, DA2**

The addresses for the Host Link Unit connected to the host computer are set.

**DNA (Destination Network Address)**

The network address (00 to 7F Hex) of the CPU Unit is set in hexadecimal.

**DA1 (Destination Node Address)**

The node address (01 to 7E Hex) of the CPU Unit is set in hexadecimal.

**DA2 (Destination Unit Address)**

The unit address of the Host Link port is set.

**SNA, SA1, SA2**

The addresses for the source node (e.g., PLC, FA computer) are set.

**SNA (Source Network Address)**

The network address (00 to 7F Hex) of the source is set in hexadecimal.

**SA1 (Source Node Address)**

The node address (01 to 7E Hex) of the source is set in hexadecimal.

**SA2 (Source Unit Address)**

The unit address of the source is set.

**SID (Source ID)**

Automatically set by the CPU Unit using SEND(090), RECV(098), and CMND(490).

**3-5-7 Response Format Returned by the Host Computer**

Responses to FINS commands received by the host computer are returned in the format shown below.

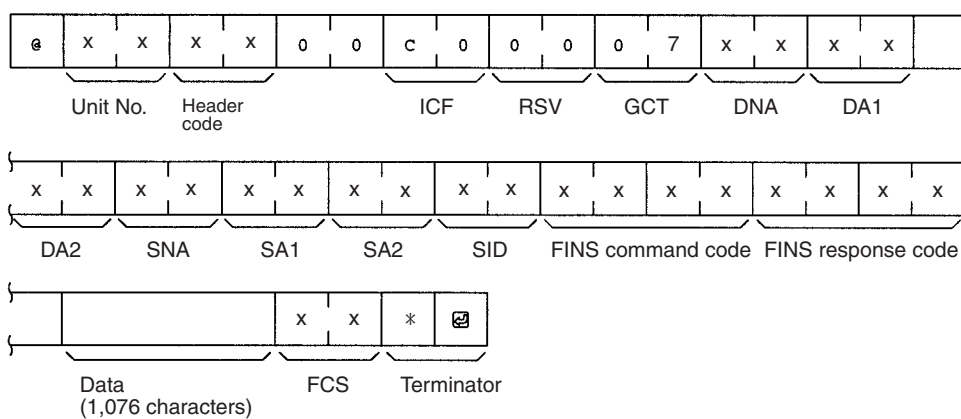

**ICF (Information Control Field)**

“C0” (ASCII: 43, 30) will be returned.

**RSV (Reserved)**

“00” (ASCII: 30, 30) is returned.

**GCT (Gateway Count)**

“07” (ASCII: 30, 37) is returned.

**DNA (Destination Network Address), DA1 (Destination Node Address), DA2 (Destination Unit Address)**

The same contents specified for SNA, SA1, and SA2 in the command that was received will be returned.

**SNA (Source Network Address), SA1 (Source Node Address), SA2 (Source Unit Address)**

The same contents specified for DNA, DA1, and DA2 in the command that was received will be returned.

**SID (Source ID)**

The SID that was specified in the command that was received will be returned.

**Command Code**

The command code that was specified in the command that was received will be returned.

**Note** The length of the response cannot exceed 1,115 characters. Create responses so that the response data without the response code is less than 1,076 characters (538 bytes).



**3-5-8 Flags for Network Communications**

This section describes the flags in the Auxiliary Area that are used when executing SEND(090), RECV(098), and CMND(490).

**Communications Port Enabled Flags**

A Communications Port Enabled Flag turns ON when SEND(090), RECV(098), and CMND(490) can be executed. The Flag will turn OFF during execution of these commands and turn ON again when the command execution is completed. When creating the ladder diagram, use these Flags as input conditions when executing these instructions.

| Word | Bit      | Content  |
|------|----------|--|
| A202 | 15       | Network Communications Automatic Allocation Enabled Flag |
|      | 09 to 14 | Reserved   |
|      | 08       | CJ2 Network Communications Instruction Enabled Flag      |
|      | 07       | Communications Port Enabled Flag, Port No. 7             |
|      | 06       | Communications Port Enabled Flag, Port No. 6             |
|      | 05       | Communications Port Enabled Flag, Port No. 5             |
|      | 04       | Communications Port Enabled Flag, Port No. 4             |
|      | 03       | Communications Port Enabled Flag, Port No. 3             |
|      | 02       | Communications Port Enabled Flag, Port No. 2             |
|      | 01       | Communications Port Enabled Flag, Port No. 1             |
|      | 00       | Communications Port Enabled Flag, Port No. 0             |

**Communications Port Error Flags**

A Communications Port Error Flag will turn ON in the following cases.

- When an error is generated during execution of SEND(090), RECV(098), or CMND(490).
- When an error response or retry error has been generated for the port.

These Flags will turn OFF when the corresponding Communications Port Enabled Flag is turned OFF at the start of operation or at the start of executing the SEND(090), RECV(098), or CMND(490).

| Word | Bit      | Content                                    |
|------|----------|--|
| A219 | 15 to 08 | Reserved                                   |
|      | 07       | Communications Port Error Flag, Port No. 7 |
|      | 06       | Communications Port Error Flag, Port No. 6 |
|      | 05       | Communications Port Error Flag, Port No. 5 |
|      | 04       | Communications Port Error Flag, Port No. 4 |
|      | 03       | Communications Port Error Flag, Port No. 3 |
|      | 02       | Communications Port Error Flag, Port No. 2 |
|      | 01       | Communications Port Error Flag, Port No. 1 |
|      | 00       | Communications Port Error Flag, Port No. 0 |

**Communications Port Completion Codes**

The Communication Port Completion Code words will contain the FINS end code after SEND(090), RECV(098), or CMND(490) has been executed. If the Communications Port Enabled Flag turns OFF when operation is started or SEND(090), RECV(098), or CMND(490) are executed, the contents of these words will be cleared.

| Word         | Content   |
|--------------|---|
| A203         | Communications Port Completion Code, Port No. 0 |
| A204         | Communications Port Completion Code, Port No. 1 |
| A205         | Communications Port Completion Code, Port No. 2 |
| A206         | Communications Port Completion Code, Port No. 3 |
| A207         | Communications Port Completion Code, Port No. 4 |
| A208         | Communications Port Completion Code, Port No. 5 |
| A209         | Communications Port Completion Code, Port No. 6 |
| A210         | Communications Port Completion Code, Port No. 7 |
| A211 to A218 | Reserved  |

**Flag Transitions**

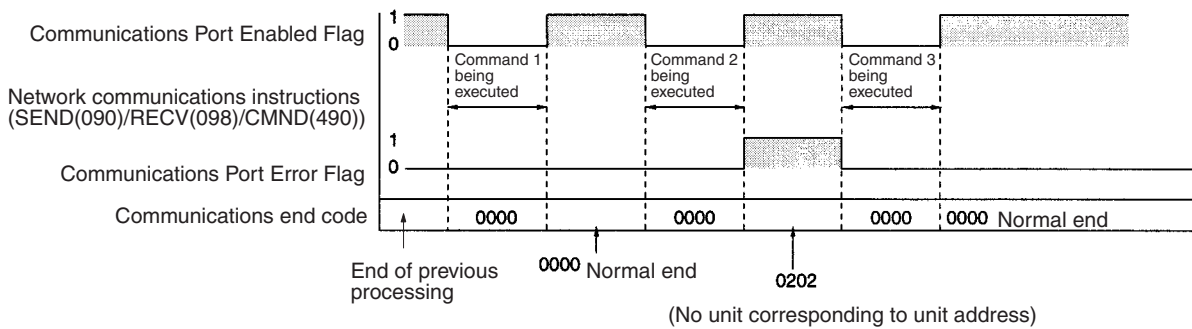

**3-5-9 Timing of Commands to Host Computers**

Commands sent to a host computer are transmitted with the timing shown below.

**Data Received from Host Computer**

**Response Required**

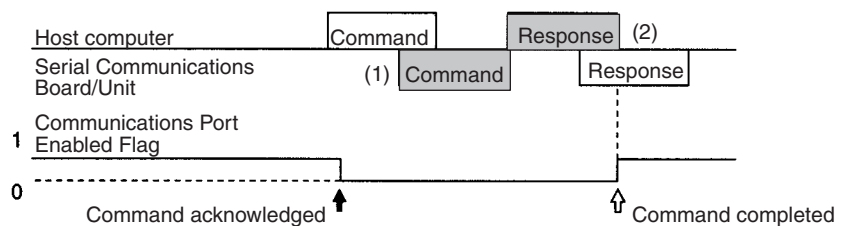

**No Response Required**

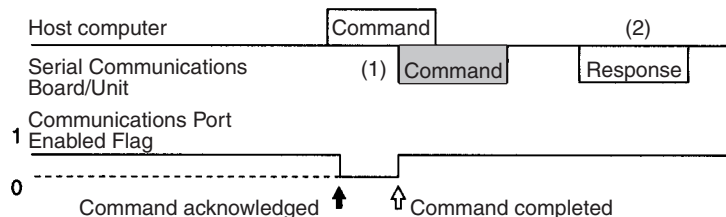

Command transmission to the host computer can commence even when the port is receiving a command from the host computer (1). The transmission of a response to the command from the host computer is postponed until the transmission of the command to the host computer is completed (2).

When a response is not required from the host computer, the Communications Port Enabled Flag will turn ON when the command to the host computer has passed from the CPU Unit to the port.

**Host Computer Receiving Data**

**Response Required**

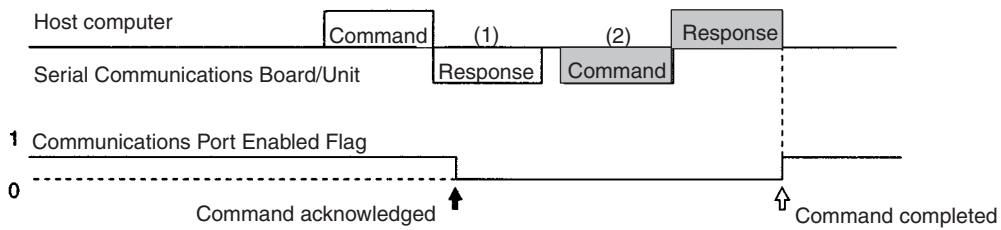

**No Response Required**

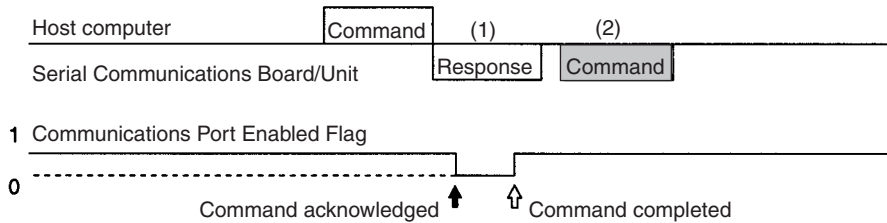

At (1) in the diagram, the response to a command sent from the host computer is being transmitted from the port. In this case, the command transmission to the host computer is postponed until the response transmission is completed (2).

When a response is not required from the host computer, the Communications Port Enabled Flag will turn ON when the command to the host computer has passed from the CPU Unit to the port.

**Response Wait Time**

**Response Required**

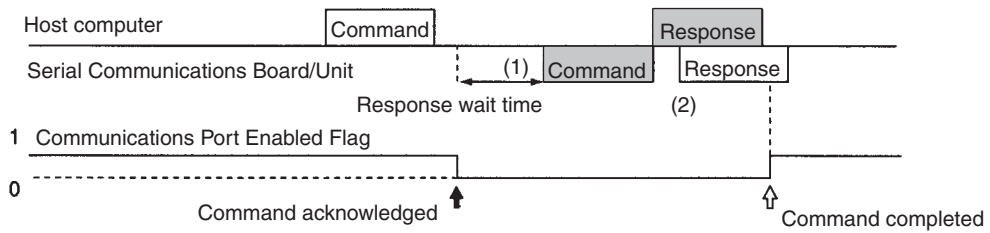

**No Response Required**

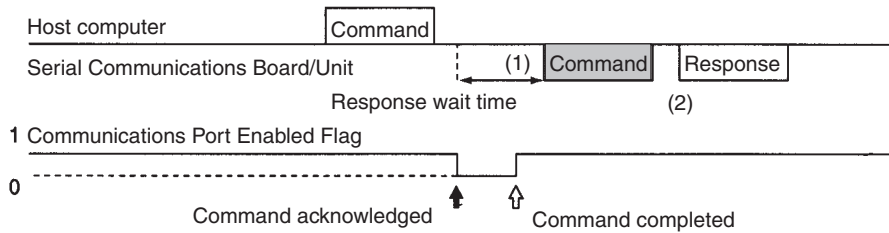

When response wait time has been set in the command format from the host computer, commands to the host computer will not be transmitted until the response time has elapsed (1). Transmission of responses to commands from the host computer will be postponed until the command transmission to the host computer has been completed.

When a response is not required from the host computer, the Communications Port Enabled Flag will turn ON when the command to the host computer has passed from the CPU Unit to the port.

3-5-10 Programming Example

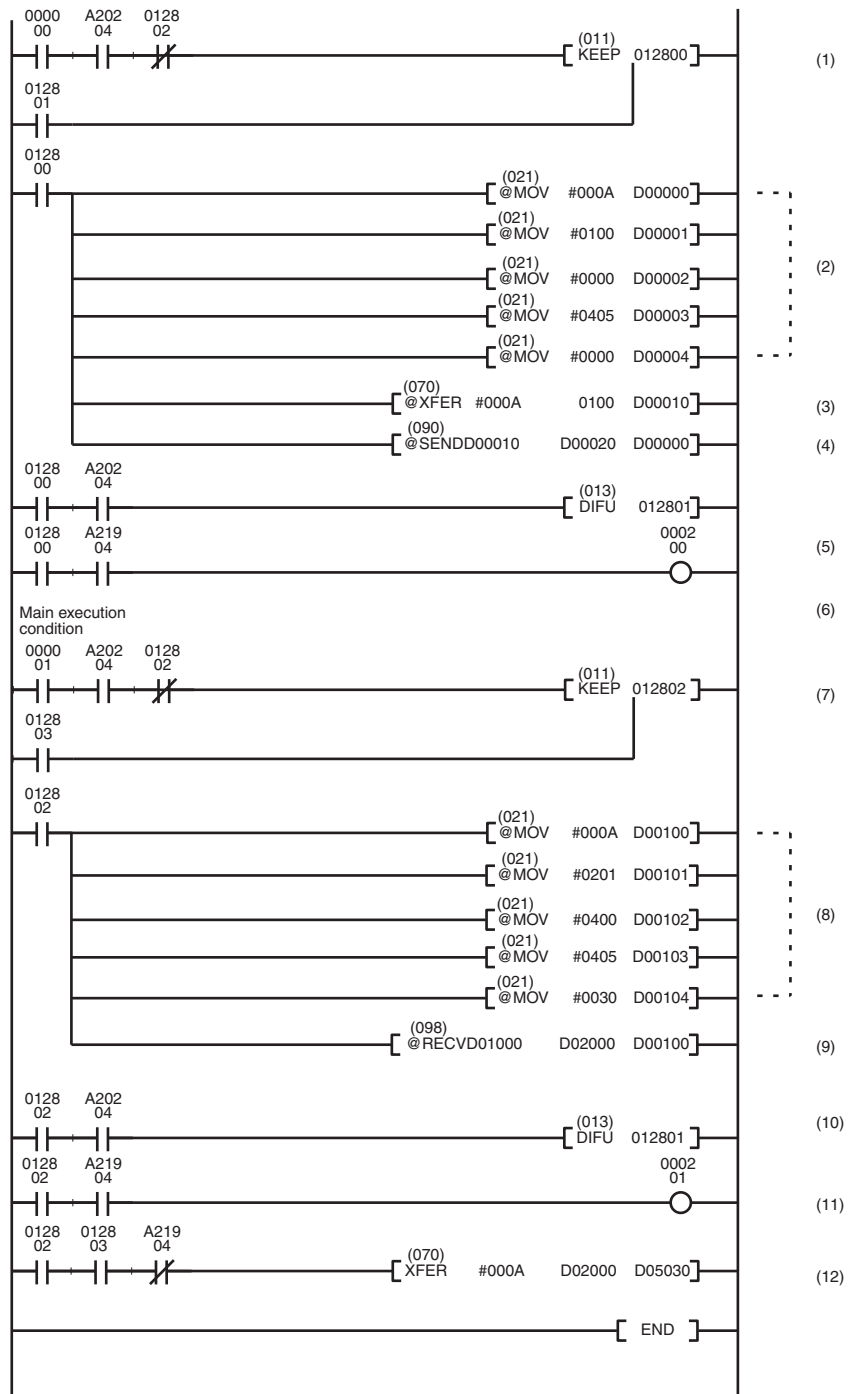

- 1,2,3...** 1. When the SEND(090)/RECV(098) Enabled Flag is ON, and the execution condition CIO 000000 is ON, execution of the instructions for network transmissions are started. CIO 0128.00 will remain ON from when SEND(090) is started until execution has been completed.

2. Set the control data.

|        |    |    |  |
|--------|----|----|--|
| D00000 | 00 | 0A | ← Number of send words: 10   |
| D00001 | 01 | 00 | ← Serial port 1 (peripheral port)<br>Destination network address \$00 (B network)    |
| D00002 | 00 | 00 | ← Destination node address \$00 (B node)<br>Destination unit address \$00 (CPU Unit) |
| D00003 | 04 | 05 | ← Response required, Communications port No. 4<br>Number of retries: 5               |
| D00004 | 00 | 00 | ← Response monitor time: 2 s (\$0000: Default)                                       |

3. Transmit Data Stored  
Stores 10 words of data starting from CIO 0100 to D00010 and later.
4. Execute SEND(090).
5. When the instruction for network communications has been completed (A202.04: ON), CIO 0128.01 will turn ON, and the instruction for sending on the network is completed.
6. Turns ON when an error is generated during execution of network communications.
7. When the Communications Port Enabled Flag is ON and execution condition CIO 0000.01 is ON, execution of the instruction for receiving via the network (RECV(098)) is started.
8. Set the control data.

|        |    |    |  |
|--------|----|----|--|
| D00100 | 00 | 0A | ← Number of receive words: 10<br>Serial port 2   |
| D00101 | 02 | 01 | ← Source network address \$01<br>Source node address \$04                                |
| D00102 | 04 | 00 | ← Source unit address \$01 (Inner Board)<br>Response required, Communications port No. 4 |
| D00103 | 04 | 05 | ← Number of retries: 5   |
| D00104 | 00 | 30 | ← Response monitor time: 4.8 s (\$0030)  |

9. Execute RECV(098).
10. When the execution of network communications instructions has been completed (A202.04: ON), CIO 0128.03 will turn ON, and the instruction for receiving via the network is completed.
11. Turns ON when an error is generated during execution of network communications.
12. Reception data processing  
When there is no reception error, 10 words of data (starting from D02000) are stored from D05030 onwards.

**Programming Example for Host Computer Side (BASIC): Send**

```

10 ' *****
20 ' **** CS1W-SCU21 Serial Communications Unit ****
30 ' **** Command to Host Computer (SEND(090)) ****
40 ' **** Sample Send Program ****
50 ' *****
60 '
70 ' ===== Initial Settings =====
80 CLOSE 1
90 ON ERROR GOTO *EROPE
100 DIM CHDATA$ (300)           : ' Data array declaration
110 OPEN "COM:E73" AS #1       : ' Opens port.
120 '
130 ' ===== Main Process =====
140 INPUT #1, COMMAND$         : ' Receives data from PLC (line) .
150 T$=LEFT$(COMMAND$, LEN (COMMAND$) -3) : ' Checks FCS.
160 GOSUB *FCS
170 IF FCS$<>MID$(COMMAND$, LEN (COMMAND$) -2, 2) THEN ENDCODE$="1004":GOTO *RESPONSE
180 CMNDCODE$=MID$(COMMAND$, 27, 4)      : ' Checks command code.
190 IF CMNDCODE$<>"0102" THEN ENDCODE$="0401" :GOTO *RESPONSE
200 FOR I=0 TO VAL ("&H"+MID$(COMMAND$, 39, 4) ) -1 : ' Sets No. of write elements.
210   CHDATA$(I) =MID$(COMMAND$, 43+I*4, 4)
220   PRINT "Data";";";CHDATA$(I)
230 NEXT I
240 ENDCODE$="0000"           : ' Sets end code to "0000".
250 ' =====
260 *RESPONSE                 : ' Creates a response frame .
270 RSV$=MID$(COMMAND$, 9, 2) : ' Returns received RSV, SID
280 DA$=MID$(COMMAND$, 19, 6) : ' without change.
290 SA$=MID$(COMMAND$, 13, 6) : ' Swaps DNA, DA1, DA2
300 SID$=MID$(COMMAND$, 25, 2) : ' with SNA, SA1, and SA2.
310 T$="@000F00C0"+RSV$+"02"+DA$+SA$+SID$+CMNDCODE$+ENDCODE$
320 GOSUB *FCS
330 RESPONSE$=T$+FCS$+"*"
340 PRINT #1, RESPONSE$      : ' Transmits data to PLC (line) .
350 GOTO 140
360 '
370 ' ===== FCS Calculation Subroutine =====
380 *FCS                       : ' Adds FCS.
390 L=LEN (T$)
400 A=0
410 FOR J=1 TO L
420   TJ$=MID$(T$, J, 1)
430   A+ASC (TJ$) XOR A
440 NEXT J
450 FCS$=HEX$(A)
460 IF LEN (FCS$) =1 THEN FCS$="0"+FCS$
470 RETURN
480 '
490 ' ===== Error processing =====
500 *EROPE
510 PRINT "ERL=":ERL, "ERR":ERR
520 CLOSE 1
530 END

```

**Programming Example for Host Computer Side (BASIC): Reception**

```

10  '*****
20  '**** CS1W-SCU21 Serial Communications Unit ****
30  '**** Command to Host Computer (RECV(098)) ****
40  '**** Sample Reception Program ****
50  '*****
60  '
70  '===== Initial Settings =====
80  CLOSE 1
90  ON ERROR GOTO *EROPE
100 DIM CHDATA$ (300)                                :' Data array declaration
110 CHDATA$ (0) ="0000":CHDATA$ (1) ="1111":CHDATA$ (2) ="2222"
120 CHDATA$ (3) ="3333":CHDATA$ (4) ="4444":CHDATA$ (5) ="5555"
130 OPEN "COM:E73" AS #1                              :' Opens port.
140 '
150 '===== Main Process =====
160 RESPDATA$=""
170 INPUT #1, COMMAND$                                :' Receives data from PLC (line) .
180 T$=LEFT$ (COMMAND$, LEN (COMMAND$) -3)           :' Checks FCS .
190 GOSUB *FCS
200 IF FCS$<>MID$ (COMMAND$, LEN (COMMAND$) -2, 2) THEN ENDCODE$="1004":GOTO *RESPONSE
210 CMNDCODE$=MID$ (COMMAND$, 27, 4)                  :' Checks command code .
220 IF CMNDCODE$<>"0101" THEN ENDCODE$="0401" :GOTO *RESPONSE
230 FOR I=0 TO VAL ("&H"+MID$ (COMMAND$, 39, 4) ) -1 :' Sets No. of read elements .
240     RESPDATA$=RESPDATA$+CHDATA$ (I)
250 NEXT I
260 PRINT "Send data";RESPDATA$
270 ENDCODE$="0000"                                  :' Sets end code to "0000".
280 '=====
290 *RESPONSE                                        :' Creates a response frame .
300 RSV$=MID$ (COMMAND$, 9, 2)                        :' Returns received RSV, SID
310 DA$=MID$ (COMMAND$, 19, 6)                        :' without change.
320 SA$=MID$ (COMMAND$, 13, 6)                        :' Swaps DNA, DA1, DA2
330 SID$=MID$ (COMMAND$, 25, 2)                       :' with SNA, SA1, and SA2.
340 T$="@000F00C0"+RSV$+"02"+DA$+SA$+SID$+CMNDCODE$+ENDCODE$+RESPDATA$
350 GOSUB *FCS
360 RESPONSE$=T$+FCS$+"*"
370 PRINT #1, RESPONSE$                              :' Transmits data to PLC (line) .
380 GOTO 160
390 '
400 '===== FCS Calculation Subroutine =====
410 *FCS                                              :' Adds FCS .
420 L=LEN (T$)
430 A=0
440 FOR J=1 TO L
450     TJ$=MID$ (T$, J, 1)
460     A+ASC (TJ$) XOR A
470 NEXT J
480 FCS$=HEX$ (A)
490 IF LEN (FCS$) =1 THEN FCS$="0"+FCS$
500 RETURN
510 '
520 '===== Error processing =====
530 *EROPE
540 PRINT "ERL=":ERL, "ERR":ERR
550 CLOSE 1
560 END

```



### 3-6 Serial Gateway Overview

#### 3-6-1 Overview

FINS messages (commands) that are received are automatically converted into the corresponding protocol and then sent via serial communications. The responses are also automatically converted. FINS messages can be converted into the following protocols.

- CompoWay/F
- Modbus-RTU
- Modbus-ASCII
- Host Link FINS (FINS commands enclosed in Host Link header and terminator)

**Note** Serial Communications Boards/Units can receive FINS commands via a FINS network (including Host Link FINS) or via the CPU bus.

#### Applicable Units and Serial Communications Ports

| Command after conversion | Applicable Units and serial communications ports   |
|--------------------------|--|
| CompoWay/F               | CS1-H CPU Units, CJ1-H CPU Units, CJ1M CPU Units with unit version 3.0 or later, serial port C on the Controller Section of an NSJ Controller, or serial port 1 or 2 on Option Board of CP-series CPU Unit (See note)<br><br>Serial communications port on Serial Communications Board/Unit with unit version 1.2 or later |
| Modbus-RTU               | Serial communications port on Serial Communications Board/Unit with unit version 1.2 or later or serial port 1 or 2 on Option Board of CP-series CPU Unit (See note)   |
| Modbus-ASCII             | Serial communications port on Serial Communications Board/Unit with unit version 1.2 or later  |
| Host Link FINS           | Serial communications port on Serial Communications Board/Unit with unit version 1.2 or later  |

**Note** Not possible when a CP1E CPU unit is used.

#### Using the CPU Unit

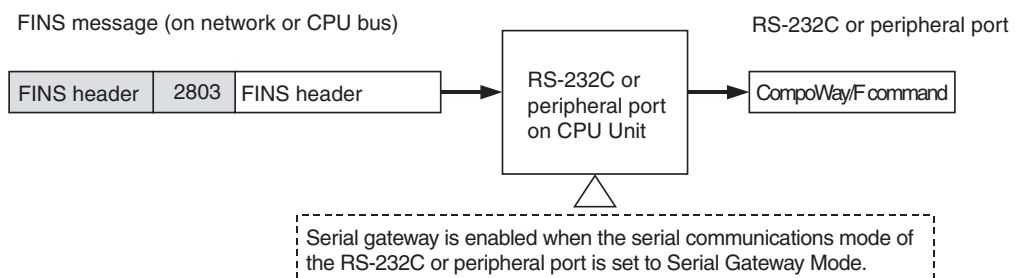

### Using a Serial Communications Board/Unit

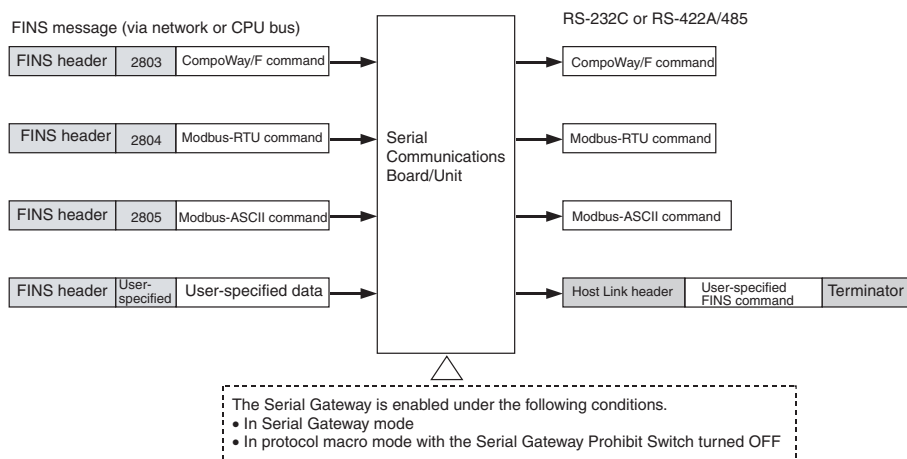

### 3-6-2 Types of Protocol Conversion

| Type of conversion (from FINS) | Frame before conversion                             |                |                      | Processing at Board/Unit   | Protocol after conversion (using serial communications) | Target (communications partner)  |
|--------------------------------|---|----------------|----------------------|--|---|--|
|                                | Destination address                                 | FINS command   | FINS data            |  |   |  |
| Converting to CompoWay/F       | Serial port number on Board/Unit                    | 2803 hex       | CompoWay/F command   | CompoWay/F command with FINS header removed sent to serial port.   | CompoWay/F command                                      | OMRON Component (e.g., Temperature Controller, Digital Panel Meter, or Smart Sensor)             |
| Converting to Modbus-RTU       |   | 2804 hex       | Modbus-RTU command   | Modbus-RTU command with FINS header removed sent to serial port.   | Modbus-RTU command                                      | Modbus-RTU Slave-compatible device (including OMRON 3G3JV, 3G3MV, and 3G3RV Inverters)           |
| Converting to Modbus-ASCII     |   | 2805 hex       | Modbus-ASCII command | Modbus-ASCII command with FINS header removed sent to serial port. | Modbus-ASCII command                                    | Modbus-ASCII Slave-compatible device (e.g., temperature controller, indicator, or power monitor) |
| Converting to Host Link FINS   | Any address except Board/Unit's serial port number. | User-specified | User-specified       | Transfers FINS command inside Host Link header and terminator.     | FINS command for Host Link communications               | OMRON PLC (CS/CJ/CP/NSJ Series, or CVM1/CV Series)   |

### 3-6-3 Converting FINS to CompoWay/F

OMRON Components connected serially to a PLC via CompoWay/F can be accessed from the CPU Unit or PT using CompoWay/F commands enclosed in FINS messages.

- Sent FINS message: FINS header + FINS command code 2803 hex + CompoWay/F command
- Message after conversion: CompoWay/F command

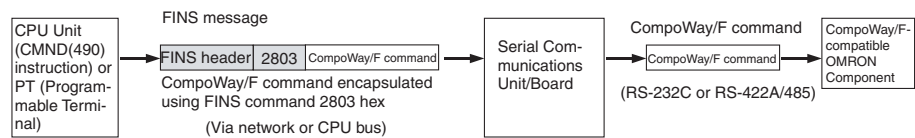

**CompoWay/F Slave-compatible Components**

| Component                          | Model series                      |                      |
|------------------------------------|-----------------------------------|----------------------|
| Temperature Controllers            | Thermac NEO                       | E5GN (G components)  |
|                                    |                                   | E5CN                 |
|                                    |                                   | E5EN                 |
|                                    |                                   | E5AN                 |
|                                    | Thermac R                         | E5AR                 |
|                                    |                                   | E5ER                 |
|                                    | Plug-in Temperature Controllers   | E5ZN                 |
| Digital Controller Boards          | E5ZM                              |                      |
| Digital Controllers                | ES100X                            |                      |
| Timer/Counters                     | Timers/Counters                   | H8GN (G components)  |
| Digital Panel Meters               | Digital Panel Meters              | K3GN (G components)  |
|                                    |                                   | K3NX                 |
|                                    | Digital Load Cell Meters          | K3NV                 |
|                                    | Digital Rotary/Pulse Meters       | K3NR                 |
|                                    | Digital Incrementing Panel Meters | K3NP                 |
|                                    | Digital Time Interval Meters      | K3NC                 |
| Digital Temperature/Process Meters | K3NH                              |                      |
| Smart Sensors                      | ZX Communications Interface Units | ZX-SF11              |
| Cam Positioners                    | ---                               | 3F88L-160, 3F88L-162 |
| Safety Controllers                 | ---                               | F3SX                 |

**System Configuration Patterns**

**Sending FINS Messages Using CMND(490) in CPU Unit’s Ladder Program**

The Board/Unit converts the FINS messages to CompoWay/F protocol for sending in this operation.

**Access from CPU Unit (on the Same PLC)**

| CPU Bus-to-Serial | Details  | Routing tables to treat serial communications path as network |
|-------------------|--|---|
|                   | <p>OMRON components connected serially to the Serial Communications Board/Unit using CompoWay/F can be accessed from a CPU Unit in the same PLC.</p> | <p>Optional</p>   |

**Access from CPU Unit (PLC on the Network)**

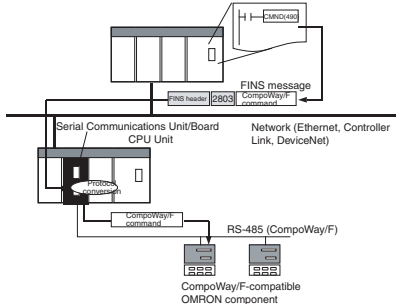
| FINS message-to-Serial  | Details  | Routing tables to treat serial communications path as network |
|---|--|---|
|  | <p>OMRON components connected serially to the Serial Communications Board/Unit using CompoWay/F can be accessed from a CPU Unit in a PLC connected to the network.</p> | <p>Optional</p>   |

**Executing Smart Active Parts Using an NS-series PT (Sending Internal FINS Messages)**

The Board/Unit converts the FINS messages to CompoWay/F protocol for sending in this operation.

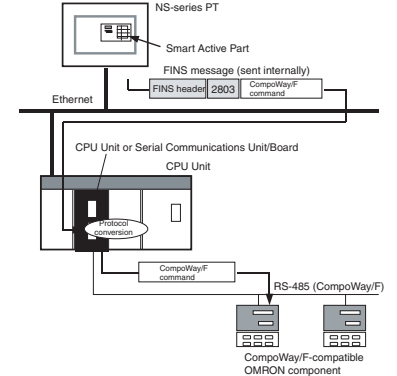
| Access from PT on Ethernet or serial NT Link  | Details  | Routing tables to treat serial communications path as network |
|---|--|---|
|  <p><b>Note</b> When the NS-series PT is connected serially to the PLC using serial communications mode (1:N NT Links), and the NS-series PT sends FINS commands encapsulated in NT Link commands using Smart Active Parts, the CPU Unit removes the NT Link header, etc. from the received command, converting it to a FINS command, and transfers the command to the Serial Communications Board/Unit. The Serial Communications Board/Unit uses the Serial Gateway to convert the command into the specified protocol. This operation enables serially connected devices to access the Serial Communications Board/Unit from Smart Active Parts using an NS-series PT.</p> | <p>Access via serial communications using CompoWay/F is possible from a PT connected to the network by executing a Smart Active Part that is connected serially, which automatically sends an internal FINS command.</p> | <p>Optional</p>   |

- Note** (1) The FINS header contains the following information.
- Remote destination network address (DNA)

- With routing tables that treat serial communications path as a network: Network address corresponding to serial port in the routing tables.
  - Without routing tables that treat serial communications path as a network: Network address for specifying actual remote PLC.
  - Remote destination node address (DA1)
    - With routing tables that treat serial communications path as a network: 00 hex (local PLC's internal communications) (For serial-to-serial-to-serial conversion, increment the Host Link unit number by 1.)
    - Without routing tables that treat serial communications path as a network: Node address for specifying actual remote PLC (For serial-to-serial-to-serial conversion, increment the Host Link unit number by 1.)
  - Remote destination unit address (DA2)  
Unit address of serial port
- (2) The contents of the CompoWay/F command enclosed in the FINS message that is sent is as follows:  
Node number + subaddress + SID + command text (ASCII must be used.)  
STX, ETX+BCC are not required when sending FINS. They are added automatically for serial communications.

### 3-6-4 Converting FINS to Modbus-RTU

Modbus-RTU Slave-compatible devices (including OMRON Inverters) connected serially to a PLC via Modbus-RTU can be accessed from the PLC or PT using Modbus-RTU commands enclosed in FINS messages.

- Sent FINS message: FINS header + FINS command code 2804 hex + Modbus-RTU command
- Message after conversion: Modbus-RTU command

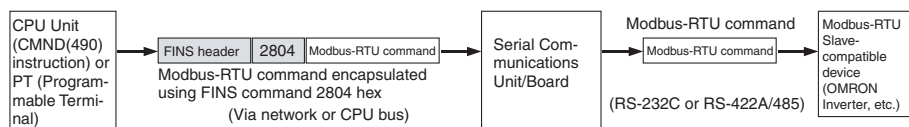

#### Modbus-RTU Slave-compatible OMRON Devices

| Type                    | Model series       |
|-------------------------|--------------------|
| Inverters               | 3G3JV              |
|                         | 3G3MV              |
|                         | 3G3RV              |
| Temperature Controllers | E5CN (New version) |

**System Configuration Patterns**

**Sending FINS Messages Using CMND(490) in CPU Unit's Ladder Program**

The Board/Unit converts the FINS messages to Modbus-RTU protocol for sending in this operation.

**Access from CPU Unit (on the Same PLC)**

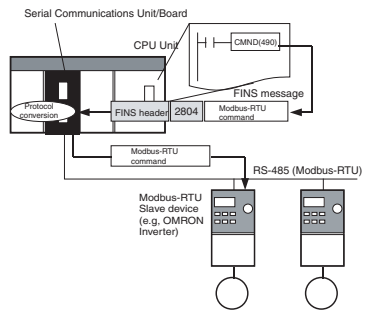
| CPU Bus-to-Serial   | Details   | Routing tables to treat serial communications path as network |
|---|---|---|
|  | <p>OMRON Inverters connected serially to the Serial Communications Board/Unit using Modbus-RTU can be accessed from a CPU Unit in the same PLC.</p> | <p>Optional</p>   |

**Access from CPU Unit (on Network PLC)**

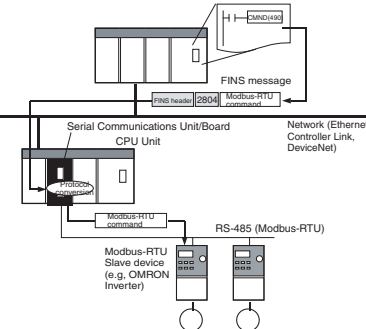
| FINS message-to-Serial   | Details   | Routing tables to treat serial communications path as network |
|--|---|---|
|  | <p>OMRON Inverters connected serially to the Serial Communications Board/Unit using Modbus-RTU can be accessed from a CPU Unit in a PLC connected to the network.</p> | <p>Optional</p>   |

**Executing Smart Active Parts Using an NS-series PT (Sending Internal FINS Messages)**

The Board/Unit converts the FINS messages to Modbus-RTU protocol for sending in this operation.

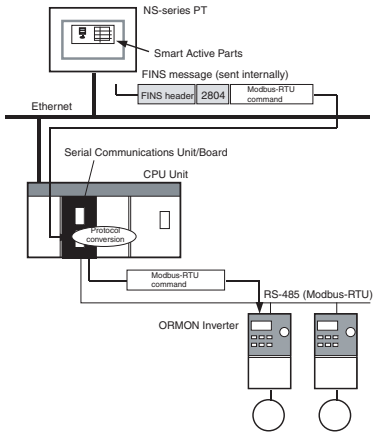
| Access from PT on Ethernet or serial NT Link   | Details  | Routing tables to treat serial communications path as network |
|--|--|---|
|  <p><b>Note</b> When the NS-series PT is connected serially to the PLC using serial communications mode (1:N NT Links), and the NS-series PT sends FINS commands encapsulated in NT Link commands using Smart Active Parts, the CPU Unit removes the NT Link header, etc. from the received command, converting it to a FINS command, and transfers the command to the Serial Communications Board/Unit. The Serial Communications Board/Unit uses the Serial Gateway to convert the command into the specified protocol. This operation enables serially connected devices to access the Serial Communications Board/Unit from Smart Active Parts using an NS-series PT.</p> | <p>Access via serial communications using Modbus-RTU is possible from a PT connected to the network by executing a Smart Active Part that is connected serially, which automatically sends an internal FINS command.</p> | <p>Optional</p>   |

**Note**

- (1) The FINS header contains the following information.
  - Remote destination network address (DNA): Same as for CompoWay/F.
  - Remote destination node address (DA1): Same as for CompoWay/F.
  - Remote unit address (DA2): Same as for CompoWay/F.
- (2) The contents of the Modbus-RTU command enclosed in the FINS message that is sent is as follows:
  - Slave address (binary) + FUNCTION code (binary) + Communications data (binary)

Start and CRC+End are not required when sending FINS. They are added automatically for serial communications.

### 3-6-5 Converting from FINS to Modbus-ASCII

Modbus-ASCII Slave-compatible devices connected serially to a PLC via Modbus-ASCII can be accessed from the PLC using Modbus-ASCII commands enclosed in FINS messages.

- Sent FINS message: FINS header + FINS command code 2805 hex + Modbus-ASCII command
- Message after conversion: Modbus-ASCII command

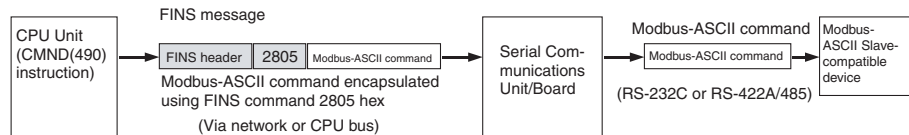

### System Configuration Patterns

#### Sending FINS Messages Using CMND(490) in CPU Unit's Ladder Program

The Board/Unit converts the FINS messages to Modbus-ASCII protocol for sending in this operation.

#### Access from CPU Unit (on the Same PLC)

| CPU Bus-to-Serial | Details   | Routing tables to treat serial communications path as network |
|-------------------|---|---|
|                   | Slaves connected serially to the Serial Communications Board/Unit using Modbus-ASCII can be accessed from a CPU Unit in the same PLC. | Optional  |

#### Access from CPU Unit (on Network PLC)

| FINS message-to-Serial | Details   | Routing tables to treat serial communications path as network |
|------------------------|---|---|
|                        | Slaves connected serially to the Serial Communications Board/Unit using Modbus-ASCII can be accessed from a CPU Unit in a PLC on the network. | Optional  |

**Note**

- (1) The FINS header contains the following information.
  - Remote destination network address (DNA): Same as for CompoWay/F.
  - Remote destination node address (DA1): Same as for CompoWay/F.
  - Remote unit address (DA2): Same as for CompoWay/F.
- (2) The contents of the Modbus-ASCII command enclosed in the FINS message that is sent is as follows:  
Slave address (ASCII) + FUNCTION code (ASCII) + Communications data (ASCII)



The header “:” (3A hex) and LRC+CR/LF are not required when sending FINS. They are added automatically for serial communications.

### 3-6-6 Converting from FINS to Host Link FINS

A PLC slave that is connected serially to the PLC master via Host Link can be accessed from the PLC master or personal computer (see note) using FINS messages. Accessing a device on another network via Host Link (serial communications) is also possible by using FINS messages. By converting the FINS to Host Link FINS, the PLC can function as a Host Link master.

**Note** Applications such as CX-Programmer or CX-Protocol that use CX-Server as a communications driver.

- Sent FINS message: FINS header + User-specified FINS command (see note 1)
- Message after conversion: FINS command enclosed in Host Link header and terminator (see note 2)

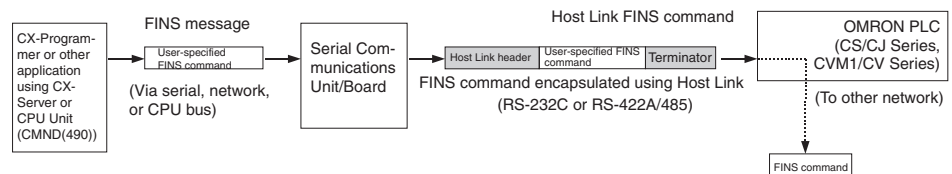

## System Configuration Patterns

### Access from CX-Programmer (Sending Internal FINS Messages)

The Board/Unit converts the FINS messages to Host Link FINS for sending in this operation.

#### Access from Serially Connected CX-Programmer

| Serial-to-Serial | Details   | Routing tables to treat serial communications path as network |
|------------------|---|---|
|                  | <p>Personal computers (e.g., CX-Programmer) connected serially (via tool bus or Host Link) to the PLC master can access a PLC slave that is connected serially to the PLC master via Host Link.</p> | <p>Optional</p>   |

Use the following method to access the serially (serial-to-serial) connected PLC from the CX-Programmer.

System Configuration Example

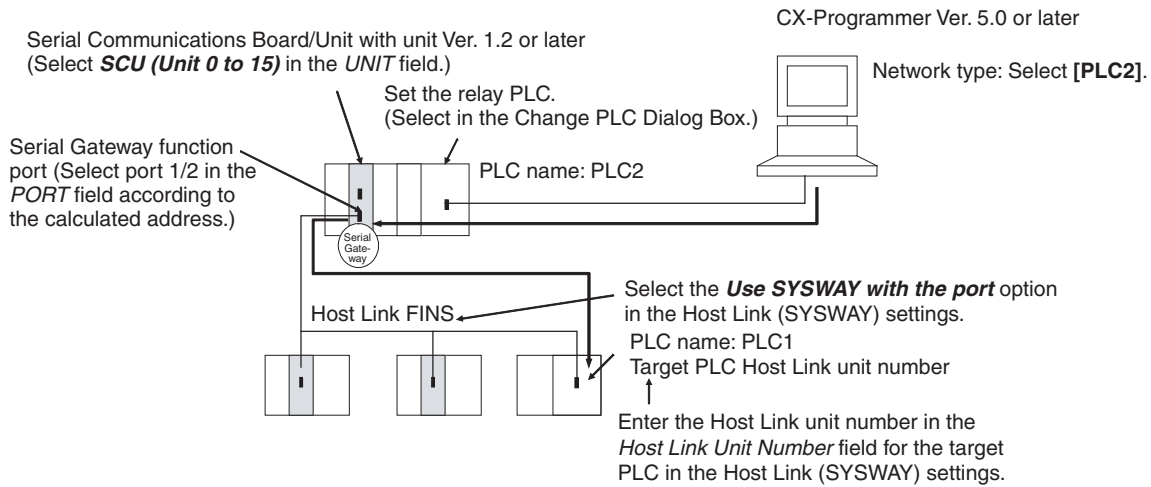

- 1,2,3...**
1. Register the PLC to be connected serially (using Host Link FINS) in the project gateway (e.g., PLC2).
  2. In the Change PLC Dialog Box of the target PLC (e.g., PLC1), select the relay PLC (gateway PLC) in the Network Type pull-down menu (e.g., [PLC2]) (See note.) and click the **Settings** Button to the right of the Network Type pull-down menu.

**Note** The PLC name enclosed in square brackets (e.g., [PLC2]) indicates the gateway PLC.

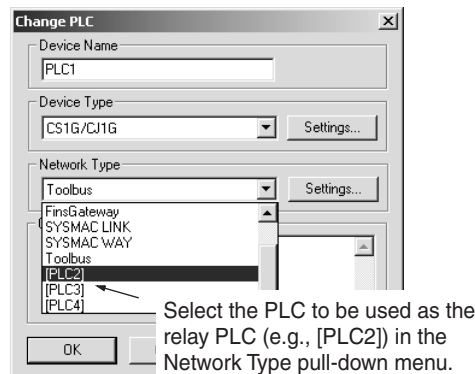

3. The Network Settings Dialog Box will be displayed. Click the **Guide for Serial Gateway** Button.
4. The **Serial Gateway Guide** Dialog Box will be displayed. Select the unit and the port number under the *Calculate Address Area*, the serial port number address is automatically calculated in the *Calculated Address Field*. Select the *Use SYSWAY with the port* option, and enter the actual Host Link unit number for the target (communications partner) PLC in the *Host Link Unit Number field* (see note). Finally, click the **Apply** Button.

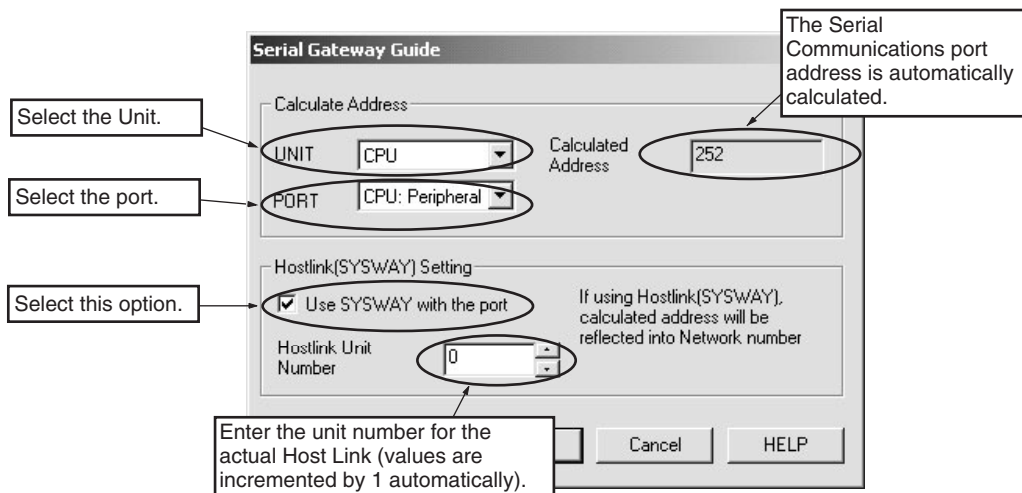

**Note** When using the CX-Programmer, enter the actual Host Link unit number. Do not add 1 to the value. The CX-Programmer will automatically add 1 internally.

**Access from CX-Programmer Connected to Network**

| Network-to-Serial  | Details  | Routing tables to treat serial communications path as network |
|--|--|---|
| <p>The diagram shows a PC (CX-Programmer, etc.) connected to a 'Network (Ethernet, Controller Link, DeviceNet)'. A 'FINS message (User-specified FINS command)' is sent from the PC to the 'Serial Communications Unit/Board' on the 'CPU Unit'. The CPU Unit is connected to a 'Host Link' (RS-422A/485) which is terminated. The Host Link connects to a 'Host Link Slave' (CS/CJ-series or CVM1/CV-series PLC). The CPU Unit is labeled 'Used as Host Link Master'.</p> | <p>Personal computers (e.g., CX-Programmer) connected through the network to the PLC master can access a PLC slave that is connected serially to the PLC master via Host Link.</p> | <p>Required</p>   |

**Note** This configuration can be connected to other networks, as shown below.

| Network-to-Serial-to-Network  | Details   | Routing tables to treat serial communications path as network |
|---|---|---|
| <p>The diagram shows a PC (CX-Programmer, etc.) connected to a 'Network (Ethernet, Controller Link, DeviceNet)'. A 'FINS message (User-specified FINS command)' is sent from the PC to the 'Serial Communications Unit/Board' on the 'CPU Unit'. The CPU Unit is connected to a 'Host Link' (RS-422A/485) which is terminated. The Host Link connects to a 'Host Link Slave' (CS/CJ-series or CVM1/CV-series PLC). The CPU Unit is labeled 'Used as Host Link Master'. The Host Link Slave is also connected to another 'Network (Ethernet, Controller Link, DeviceNet)'.</p> | <p>Personal computers (e.g., CX-Programmer) connected through the network to the PLC master can access a PLC on another network via a PLC slave that is connected serially to the PLC master via Host Link.</p> | <p>Required</p>   |

**Sending FINS Messages or Sending/Receiving Data Using CMND(490), RECV(098), SEND(090) in the CPU Unit's Ladder Program**

The Board/Unit converts the FINS messages to Host Link FINS in this operation.

**Access from CPU Unit (on the Same PLC)**

| CPU bus-to-Serial | Details   | Routing tables to treat serial communications path as network |
|-------------------|---|---|
|                   | <p>Slave PLCs connected serially to the Serial Communications Board/Unit using Host Link can be accessed from the CPU Unit in the same PLC.</p> | <p>Optional</p>   |

**Access from CPU Unit (on Network PLC)**

| Network-to-Serial | Details   | Routing tables to treat serial communications path as network |
|-------------------|---|---|
|                   | <p>Slave PLCs connected serially to the Serial Communications Board/Unit using Host Link can be accessed from a CPU Unit in a PLC connected to the network.</p> | <p>Required</p>   |

**Note** This configuration can be connected to other networks, as shown below

| Network-to-Serial-to-Network | Details   | Routing tables to treat serial communications path as network |
|------------------------------|---|---|
|                              | <p>CPU Units in PLCs connected to the network can access a PLC on another network via a PLC slave that is connected serially to the Serial Communications Board/Unit via Host Link.</p> | <p>Required</p>   |

**Note** (1) The FINS header contains the following information.

- Remote destination network address (DNA)
    - With routing tables that treat serial communications path as a network: Network address corresponding to serial port in the routing tables.
    - Without routing tables that treat serial communications path as a network: Unit address of serial port.
  - Remote destination node address (DA1)
    - With routing tables that treat serial communications path as a network: Unit number for Host Link incremented by 1 (1 to 32)
    - Without routing tables that treat serial communications path as a network: Unit number for Host Link incremented by 1 (1 to 32)
  - Remote destination unit address (DA2)  
Any unit address except that for the serial port (The destination for the FINS message must not be the serial port of the Board/Unit.)
  - FINS command code: Any
- (2) When creating Host Link FINS command frames using the CMND(490) instruction, always set the unit number for Host Link incremented by one (1 to 32) for the remote destination (send destination) node address (word C+3, bits 08 to 15 of the CMND(490) instruction). Do not set the unit number of the actual Host Link slave (0 to 31). Using the Host Link unit number without incrementing by one will access the PLC with the entered Host Link unit number less one.  
For example, specify the remote PLC with Host Link unit number 2 by entering **3** for the remote destination node address. If 2 is entered, the PLC with Host Link unit number 1 will be accessed.  
To access a PLC on a Host Link FINS network using the Serial Gateway from CX-Programmer, however, enter the actual Host Link unit number, without incrementing by one. (Select **Change PLC**, click the **Display Serial Gateway Guide** Button, and set unit number in the **Host Link SYS-WAY Settings** field of the Serial Gateway Guide Dialog Box.)
- (3) The contents of the FINS command enclosed by the Host Link header and terminator is as follows:  
@+Host Link unit number + Host Link header FA + FINS header + FINS command + Text + FCS + \* + CR

### 3-6-7 Treating Serial Communications Paths as Networks

When the Serial Gateway is executed, routing tables are either required or optional as follows:

- Routing tables are required to treat a serial communications path as a network when converting FINS messages to Host Link FINS for serial conversion via the network.
- Under other conditions, routing tables are optional.

The details are provided in the following tables.

Conditions Requiring Routing Tables According to Target

| Target                                    |   | Protocol conversion | Case   | Example                      | Routing tables for treating serial communications path as network |
|---|---|---------------------|--|------------------------------|---|
| PLC (CS/CJ/CP/NSJ Series, CVM1/CV Series) |   | Host Link FINS      | Routing FINS network including serial communications path (for Serial Gateway) | Network-to-serial conversion | Required  |
|   |   |                     | Serial communications path connection only                                     | Serial-to-serial conversion  | Optional  |
| Any component except PLC                  | OMRON Component                             | CompoWay/F          | Routing FINS network including serial communications path (for Serial Gateway) | Network-to-serial conversion | Optional  |
|   | Modbus-RTU Slave (including OMRON Inverter) | Modbus-RTU          | Serial communications path connection only                                     | Serial-to-serial conversion  | Optional  |
|   | Modbus-ASCII Slave                          | Modbus-ASCII        |  |                              |   |

Specifying Address in FINS Command Source

| Target                                    |   | Protocol conversion | Routing tables for treating serial communications path as network | FINS header   |  |  |
|---|---|---------------------|---|---|--|--|
|   |   |                     |   | Remote network address  | Remote node address  | Remote unit address                                      |
| PLC (CS/CJ/CP/NSJ Series, CVM1/CV Series) |   | Host Link FINS      | Created   | Network address assigned to the serial port according to the routing tables | Host Link unit number incremented by 1 (1 to 32) (See note.) | Must be the actual unit address of the destination unit. |
|   |   |                     | Not created   | Serial port unit address  |  |  |
| Any component except PLC                  | OMRON Component                             | CompoWay/F          | Created   | Network address assigned to the serial port according to the routing tables | 00 hex (indicates communications in local PLC)               | Must be the unit address of the serial port.             |
|   | Modbus-RTU Slave (including OMRON Inverter) | Modbus-RTU          | Not created   | Network address for specifying the actual remote PLC                        | Node address for specifying the actual remote PLC            |  |
|   | Modbus-ASCII Slave                          | Modbus-ASCII        |   |   |  |  |

**Note** To access from a CX-Programmer, Select **Change PLC - Serial Gateway Guide**, and enter the actual Host Link unit number, The CX-Programmer will automatically increment the value by one.

3-6-8 Using a PLC as the Target

Network-to-Serial Conversion

Routing tables are required to enable the serial communications path to be treated as a network.

Required Routing Tables

Specify the addresses as shown in the following example.

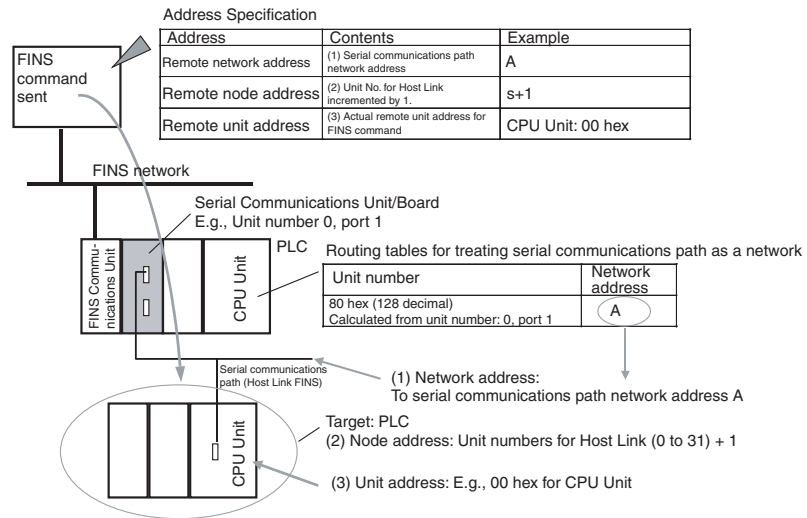

Serial-to-Serial Conversion

Routing tables to enable the serial communications path to be treated as a network are optional.

Without Routing Tables

Specify the addresses as shown in the following example.

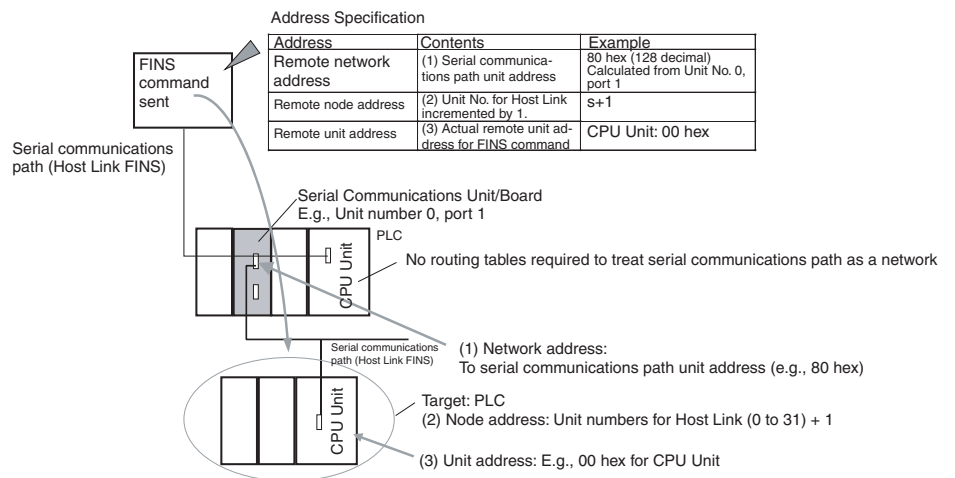

With Routing Tables

Specify the addresses as shown in the following example.

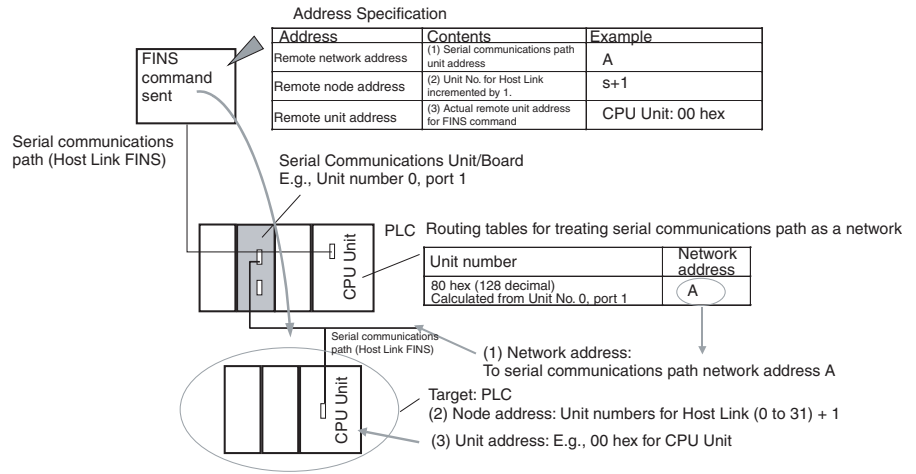

3-6-9 Using a non-PLC Component as the Target

Network-to-Serial Conversion

Routing tables to enable the serial communications path to be treated as a network are optional.

Without Routing Tables

Specify the addresses as shown in the following example.

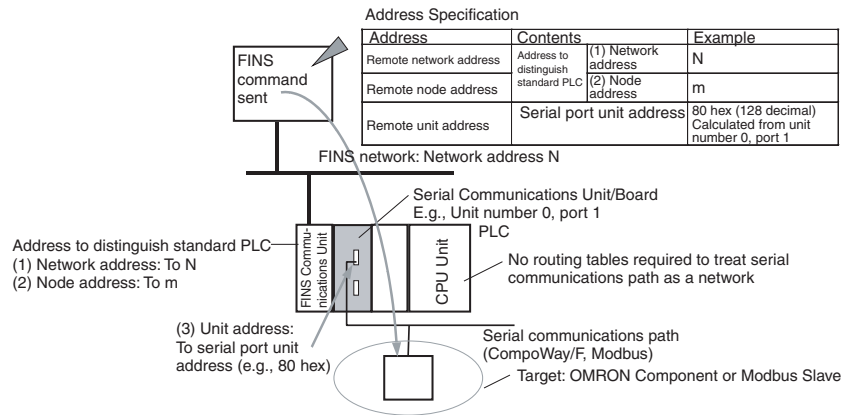



With Routing Tables

Specify the addresses as shown in the following example.

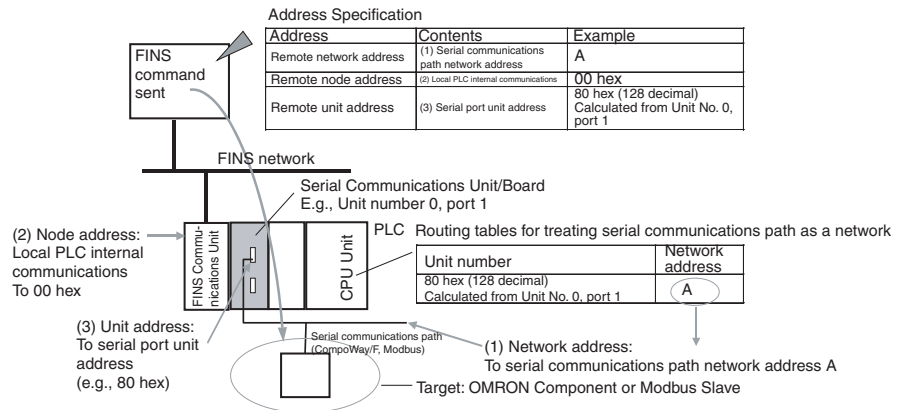

Serial-to-Serial Conversion

Routing tables to enable the serial communications path to be treated as a network are optional.

Without Routing Tables

Specify the addresses as shown in the following example.

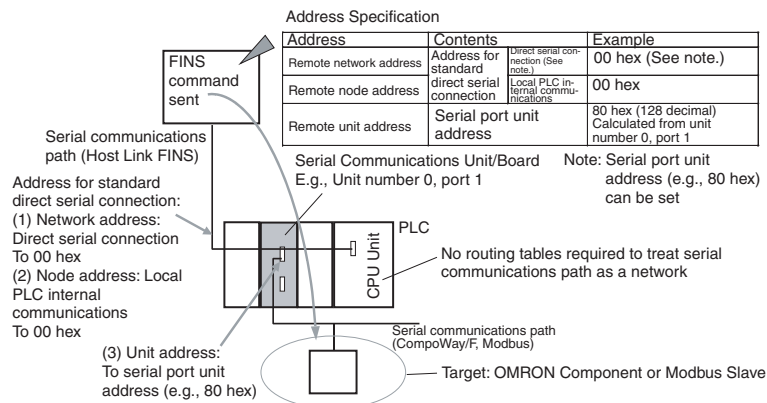

With Routing Tables

Specify the addresses as shown in the following example.

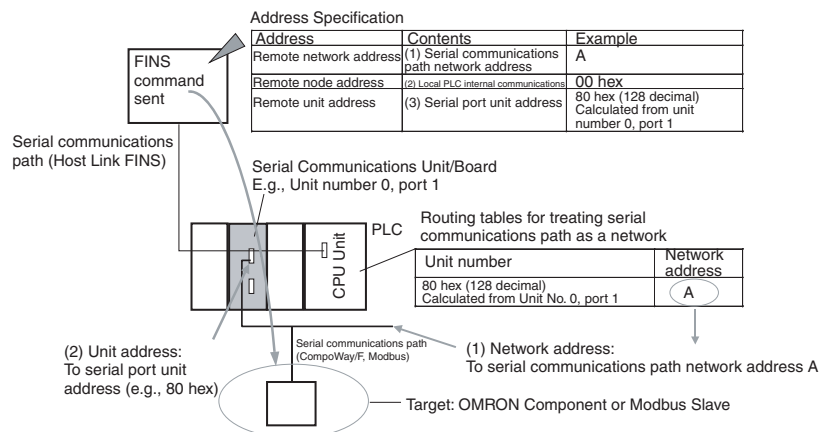

**Serial-to-Serial-to-Serial Conversion**

Routing tables to enable the serial communications path to be treated as a network are optional.

**Without Routing Tables**

Specify the addresses as shown in the following example.

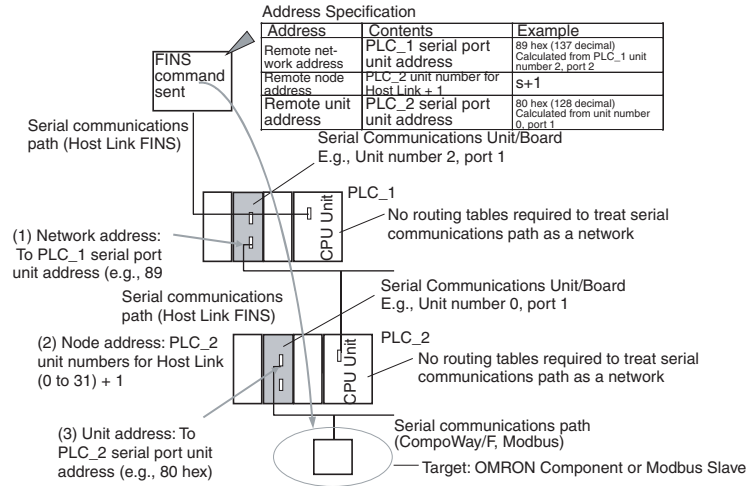

**With Routing Tables**

Specify the addresses as shown in the following example.

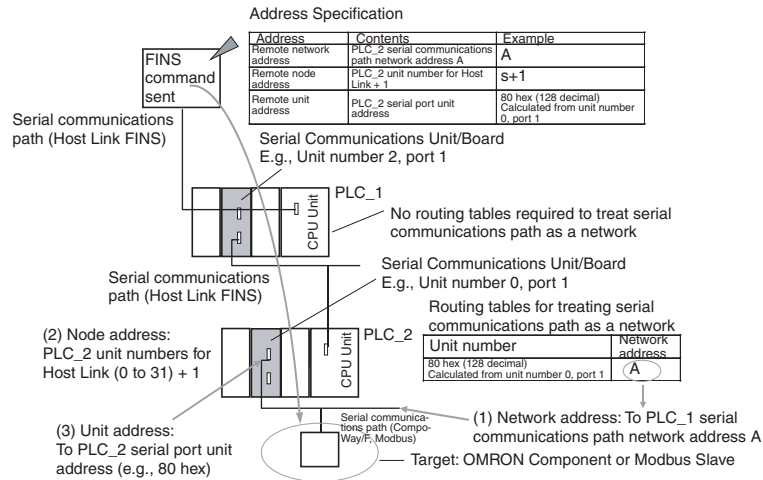

### 3-6-10 Explanation

To treat the serial communications path as a network, the serial port itself is recognized as a Communications Unit and is allocated a network address.

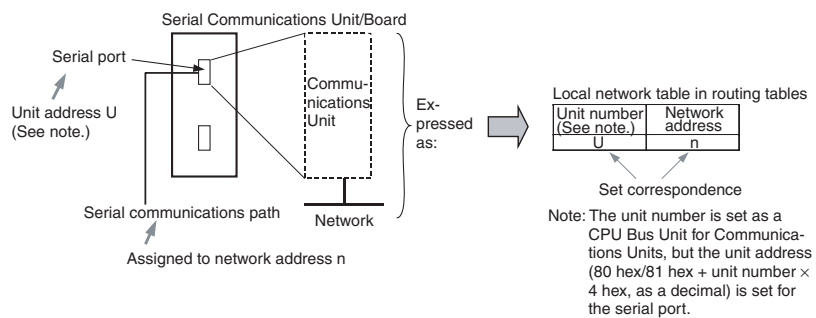
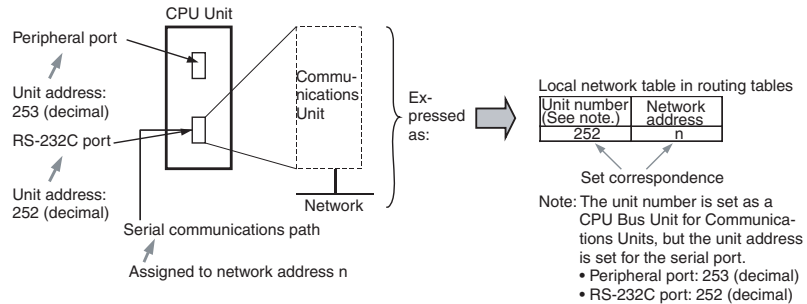

The CX-Net in the CX-Programmer is used to set the relationship between the serial port's unit address and the allocated network address in the local network tables of the routing tables. These settings are then transferred to the CPU Unit to which the Serial Communications Unit/Board is mounted.

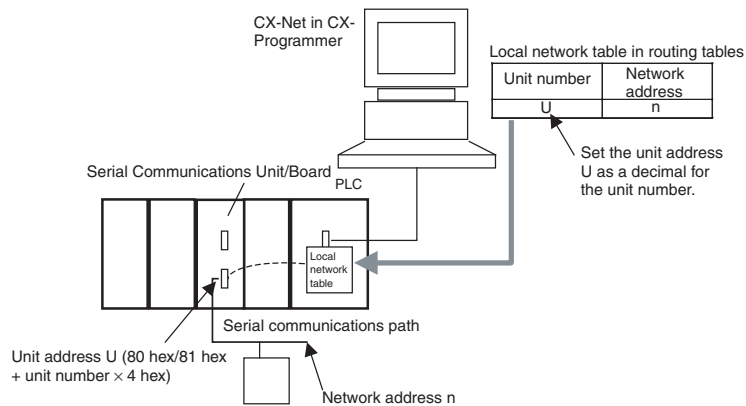

#### Unit Addresses for Serial Communications Ports

#### CS/CJ Series CPU Unit

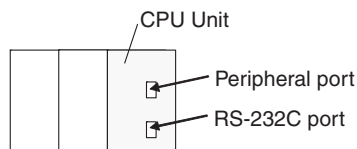

| Serial communications port on CPU Unit | Unit address         |
|--|----------------------|
| Peripheral port                        | FD hex (253 decimal) |
| RS-232C port                           | FC hex (252 decimal) |

**CP-series CPU Unit**

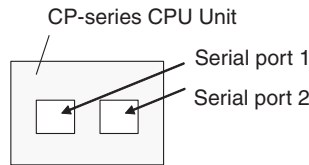

| Serial communications port on Option Board of CPU Unit | Unit address         |
|--|----------------------|
| Serial port 1  | FD hex (253 decimal) |
| Serial port 2  | FC hex (252 decimal) |

**NSJ Controller**

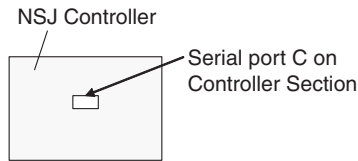

| Serial communication port on NSJ Controller | Unit address         |
|---|----------------------|
| Serial port C                               | FC hex (252 decimal) |

**Serial Communications Unit/Board**

• Serial Port 1 Unit Addresses

| Unit number | 0   | 1   | 2   | 3   | 4   | 5   | 6   | 7   | 8   | 9   | A   | B   | C   | D   | E   | F   | Board |
|-------------|-----|-----|-----|-----|-----|-----|-----|-----|-----|-----|-----|-----|-----|-----|-----|-----|-------|
| Hexadecimal | 80  | 84  | 88  | 8C  | 90  | 94  | 98  | 9C  | A0  | A4  | A8  | AC  | B0  | B4  | B8  | BC  | E4    |
| Decimal     | 128 | 132 | 136 | 140 | 144 | 148 | 152 | 156 | 160 | 164 | 168 | 172 | 176 | 180 | 184 | 188 | 228   |

• Serial Port 2 Unit Addresses

| Unit number | 0   | 1   | 2   | 3   | 4   | 5   | 6   | 7   | 8   | 9   | A   | B   | C   | D   | E   | F   | Board |
|-------------|-----|-----|-----|-----|-----|-----|-----|-----|-----|-----|-----|-----|-----|-----|-----|-----|-------|
| Hexadecimal | 81  | 85  | 89  | 8D  | 91  | 95  | 99  | 9D  | A1  | A5  | A9  | AD  | B1  | B5  | B9  | BD  | E5    |
| Decimal     | 129 | 133 | 137 | 141 | 145 | 149 | 153 | 157 | 161 | 165 | 169 | 173 | 177 | 181 | 185 | 189 | 229   |

These settings enable the serial communications path to be treated as a single FINS network. Further, the network address allocated to the serial port can be specified in the destination network address part of the FINS message. This enables messages to be passed on to serial ports in a system comprised of multiple networks connected to a single PLC (including the serial communications path).

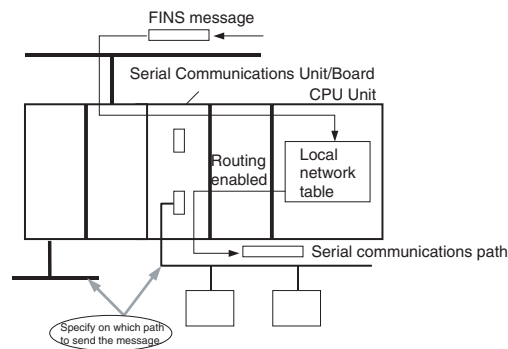

Reasons for Routing Tables

**CompoWay/F, Modbus-RTU, Modbus-ASCII Protocol Conversion**

Routing tables are not required to enable serial communications paths to be treated as networks. (The serial port can be specified in the node without using routing tables by specifying the node to which the Board/Unit is connected, and specifying the unit address as that of the serial port.)

**Host Link FINS Protocol Conversion and Use of Network**

Routing tables are required to enable the serial communications path to be treated as a network. This is because with Host Link FINS, the FINS remote node address is used to specify the target (communications partner PLC that is the Host Link slave). Therefore, the node to which the Board/Unit is mounted cannot always be specified, depending on the FINS remote node address. To specify the Unit at the target requires the FINS remote unit address. Therefore, the serial port cannot always be specified depending on the FINS unit address.

The network address for the serial communications path is used to specify from the network the node to which the Board/Unit is mounted and the serial port. Therefore, routing tables must be used to enable the serial communications path to be treated as a network.

**Host Link FINS Protocol Conversion and Use of Serial Connection**

Routing tables are not required to enable serial communications paths to be treated as networks. The serial port in the node can be specified without routing tables by specifying the network address as the unit address of the serial port.

3-7 Communications Frames

3-7-1 CompoWay/F

Command Frame

Frame before Conversion

| FINS header   |   |                           |      | FINS command |     | CompoWay/F<br>(See note.)  |   |                                   |  |                   |
|---|---|---------------------------|------|--------------|-----|--|---|-----------------------------------|--|-------------------|
| Remote network address (DNA)                              | Remote node address (DA1)               | Remote unit address (DA2) | Etc. | MRC          | SRC |  |   |                                   |  |                   |
| Serial port allocated address<br>or local network address | 00 hex<br>or local network node address | Serial port unit address  |      | 28           | 03  | Node No.<br>( $\times 10^1$ )<br>( $\times 10^2$ )<br>(ASCII code 2 bytes) | Sub-address<br>"00"<br>(ASCII code 3030 hex) etc. | SID<br>"0"<br>(ASCII code 30 hex) | Command (MRC, SRC)<br>(ASCII code 4 bytes) | Text (ASCII code) |



Frame after Conversion

| CompoWay/F   |  |   |                                   |  |                   |              |     |
|--------------|--|---|-----------------------------------|--|-------------------|--------------|-----|
| STX (02 hex) | Node No.<br>( $\times 10^1$ )<br>( $\times 10^2$ )<br>(ASCII code 2 bytes) | Sub-address<br>"00"<br>(ASCII code 3030 hex) etc. | SID<br>"0"<br>(ASCII code 30 hex) | Command (MRC, SRC)<br>(ASCII code 4 bytes) | Text (ASCII code) | ETX (03 hex) | BCC |

**Note** CompoWay/F commands use ASCII as the transmission code. Therefore, be sure to use ASCII for the CompoWay/F command after the FINS command code 2803 hex (from node number to text) using CMND(490) or other instruction.

Example: If the CompoWay/F command MRC SRC is "01" "02" (where the quotation marks ( " ") indicate ASCII characters), 0, 1, 0, 2 must be treated as ASCII characters. Therefore, set "01" as 3031 hex (not 01 hex), and "02" as 3032 hex (not 02 hex).

Further, to write the CompoWay/F command to the command storage area using CMND(490) in frame order (without creating empty bytes), the SID component of the CompoWay/F command requires 1 byte of ASCII as 30 hex, so the subsequent components (s+3 and afterwards) must be set in one byte each.

**Response Frame**

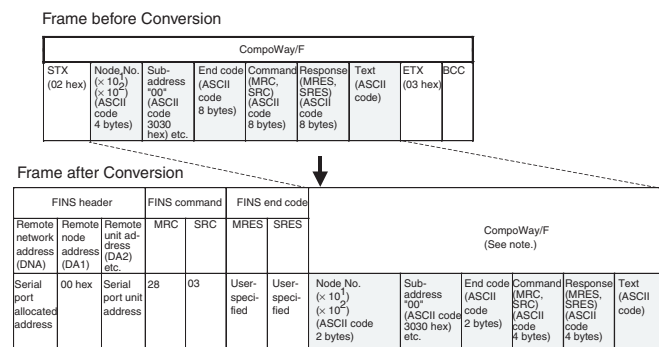

**3-7-2 Modbus-RTU**

**Command Frame**

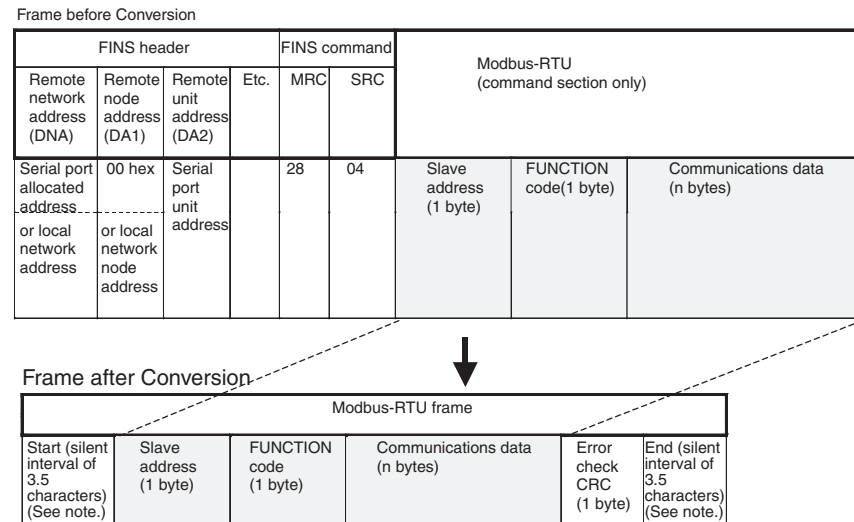

**Note** The silent interval in the Modbus-RTU frame is automatically generated by the Serial Communications Board/Unit.

**Response Frame**

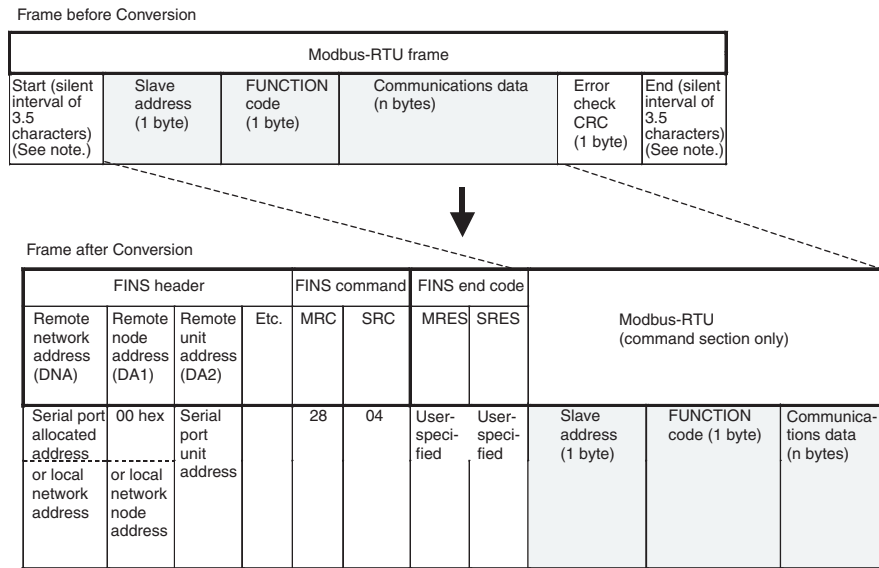

**3-7-3 Modbus-ASCII**

**Command Frame**

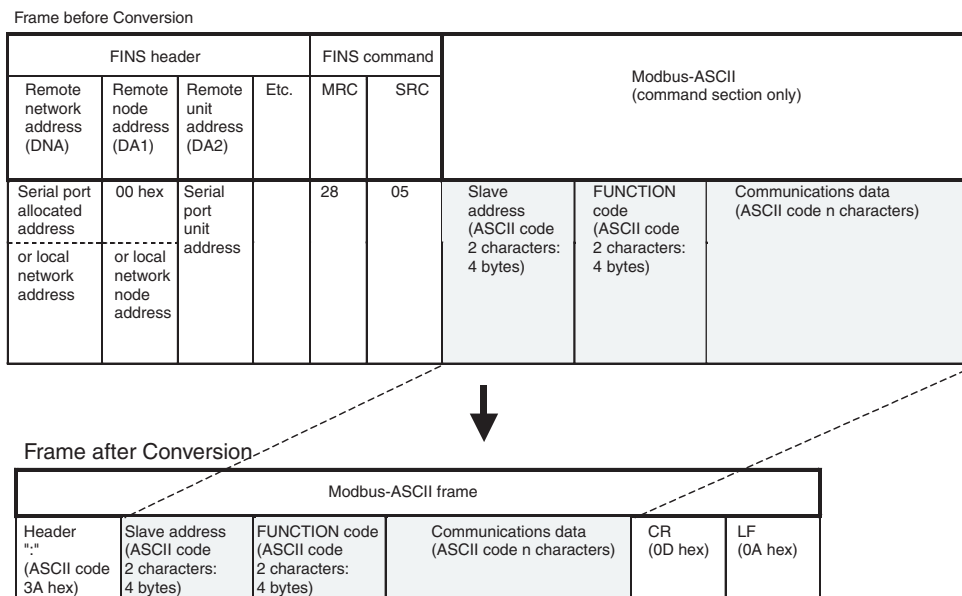

**Response Frame**

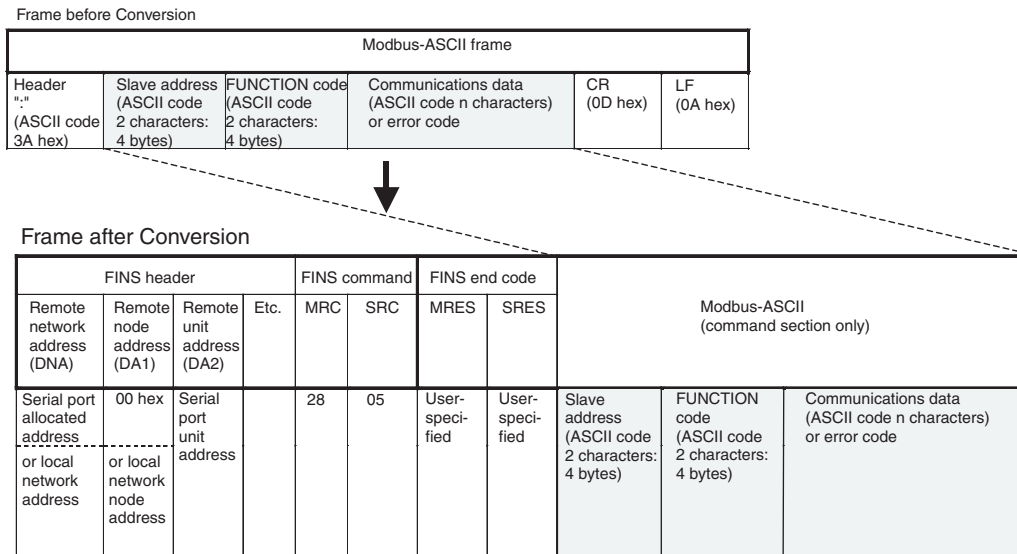

**3-7-4 Host Link FINS**

**Command Frame**

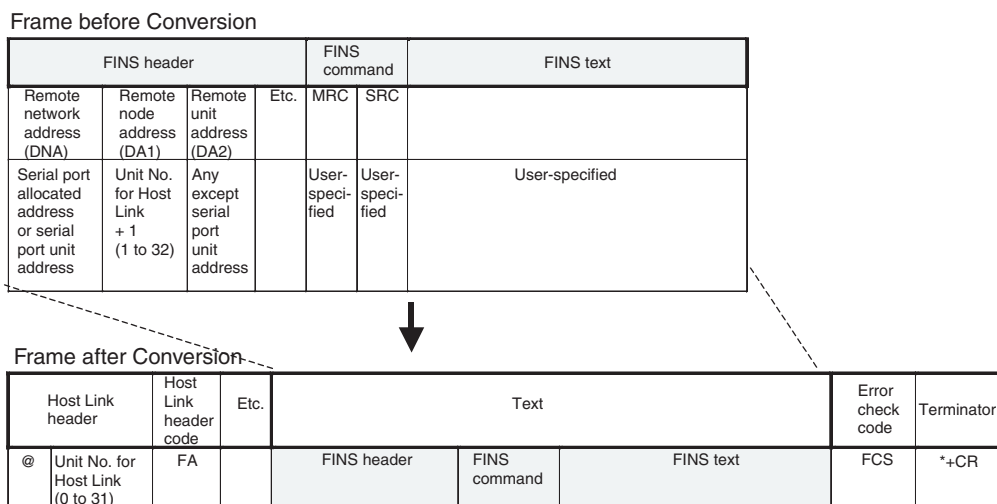



**Response Frame**

Frame before Conversion

|                  |                                  |                       |      |             |              |          |           |                  |            |
|------------------|----------------------------------|-----------------------|------|-------------|--------------|----------|-----------|------------------|------------|
| Host Link header |                                  | Host Link header code | Etc. | Text        |              |          |           | Error check code | Terminator |
| @                | Unit No. for Host Link (0 to 31) | FA                    |      | FINS header | FINS command | End code | FINS text | FCS              | *+CR       |



Frame after Conversion

|   |                                      |                                     |              |                |                |                |
|---|--------------------------------------|-------------------------------------|--------------|----------------|----------------|----------------|
| FINS header   |                                      |                                     | FINS command |                | End code       | FINS text      |
| Remote network address (DNA)                              | Remote node address (DA1)            | Remote unit address (DA2)           | Etc.         | MRC            | SRC            |                |
| Serial port allocated address or serial port unit address | Unit No. for Host Link + 1 (1 to 32) | Any except serial port unit address |              | User-specified | User-specified | User-specified |

**3-7-5 Sending Commands Using the CMND(490) Instruction**

Use the following method to send FINS commands to the Serial Communications Board/Unit from the PLC.

**Setting CMND(490) Operands**

**S Operand**

- Set the FINS command code (2803/2804/2805 hex) in S.
- Set the data without spaces (see note) following the FINS command code in S+1 onwards.

**Note** Frames are set in the same order as in I/O memory from leftmost to rightmost byte (without blank bytes (00 hex)).

**C Operand**

C+2 bits 00 to 07 (Send destination network address)

- With routing tables that treat serial communications path as a network: Network address corresponding to serial port in the routing tables.
- Without routing tables that treat serial communications path as a network:
  - CompoWay/F, Modbus: Depends on the system configuration.
  - Host Link FINS: Always set the unit address of the serial port.

C+3 bits 08 to 15 (Remote destination node address)

- CompoWay/F, Modbus
  - With routing tables that treat serial communications path as a network: 00 hex (indicates local PLC communications)
  - Without routing tables that treat serial communications path as a network: Node address for specifying the actual remote PLC
- Host Link FINS
  - Host Link unit number incremented by one (1 to 32)

C+3 bits 00 to 07 (Send destination unit address)

- CompoWay/F, Modbus
  - Always set the unit address of the serial port

**Note** Use either of the following methods to specify the serial port using the CMND(490) instruction.

- Set 80/81 hex + 4 × unit number directly as the serial port unit address in the send destination unit address bits 00 to 07 of C+3. (With this method, set the serial port number (physical port) to 0 hex (not used) in bits 08 to 11 of C+2)
  - Set the unit address of the Serial Communications Board/Unit itself (Board: E1 hex; Unit: 10 hex + unit number) in the send destination unit address bits 00 to 07 of C+3, and set the serial port numbers (Port number 1: 1 hex; Port number 2: 2 hex) in the serial port number (physical port) bits 08 to 11 of C+2.
- Host Link FINS  
Always set the unit address of the actual destination unit.

### **Sending Modbus-RTU Commands**

- Set the FINS command code 2804 hex indicating the Modbus-RTU conversion in S.
- Set the slave address (1 byte) + FUNCTION code (1 byte) + communications data (n bytes) in order of leftmost byte to rightmost bytes (see note) from S+1 onwards.

**Note** For Modbus-RTU, set the Modbus-RTU slave address (1 byte) in the leftmost byte of S+1, and the FUNCTION code (1 byte) in the rightmost byte of S+.

### **Example of Sending Modbus-RTU Command Using CMND(490) Instruction**

This example is for writing a frequency reference value from an OMRON 3G3MV Inverter connected through RS-485 to the Serial Communications Unit via two networks, Ethernet-to-Controller Link.

Example: The CMND(490) instruction is executed in the PLC for Ethernet. The Modbus-RTU command for writing frequency reference value data is sent via Ethernet to the 3G3MV Inverter (Modbus-RTU slave address: 02) that is connected to port 1 (Unit address: 80 hex + 4 hex × unit number 3 = 8C hex) of the Serial Communications Unit (Unit number: 3), that is mounted to the PLC on the Controller Link (Network address: 2; Node address: 5). The frequency reference value 10.0 Hz (set as 100 decimal in units of 0.1 Hz) is written.

The Modbus-RTU command is configured from the following elements.

Modbus-RTU slave address: 02

FUNCTION code: 10 hex (DATA WRITE)

Write start register No.: 0002 hex (frequency reference)

Write data: 0064 hex (100 decimal)

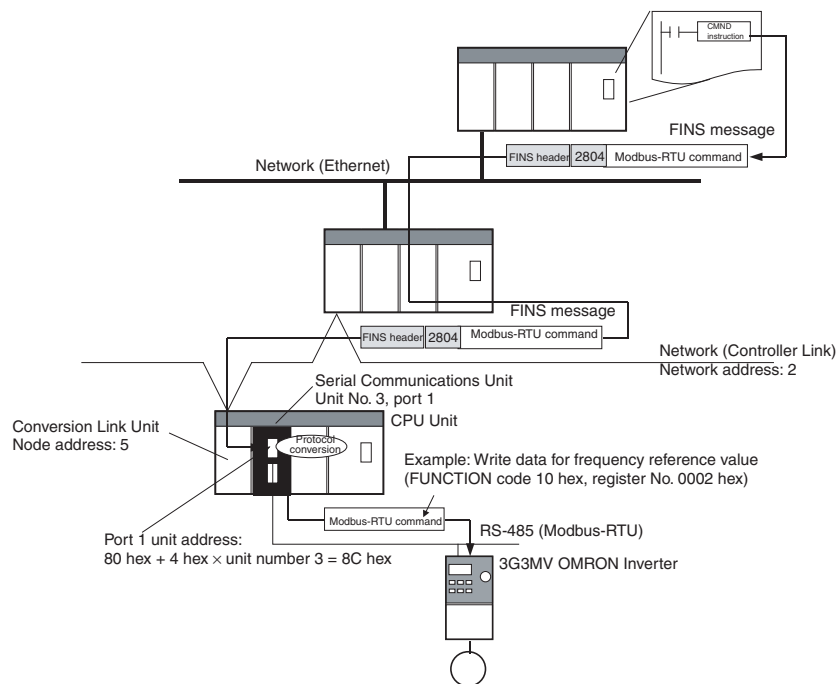

**List of Settings**

• FINS Network Settings

| Item  | Value (Example)  | Setting location   |
|---|--|--|
| Send destination network address<br>(Controller Link network address of PLC to which Serial Communications Unit is mounted) | 2  | Set 02 hex in the control data C+2 bits 00 to 07 (network address) of CMND(490).<br>Note: Set 0 hex in the control data C+2 bits 08 to 11 (serial port number) of CMND(490).   |
| Send destination node address<br>(node address in Controller Link for PLC to which Serial Communications Unit is mounted)   | 5  | Set 05 hex in the control data C+3 bits 08 to 15 (send destination node address) of CMND(490).   |
| Serial Communications Unit unit number  | 3  | Use to calculate the following unit address for the serial port  |
| Serial Communications Unit serial port  | Port 1   | 80 hex + 4 hex × unit number 3 = 8C hex  |
| Send destination unit address<br>(unit address of serial port on Serial Communications Unit)                                | 80 hex + 4 hex × unit number 3 = 8C hex (or 10 + unit number 3 - 13 hex, and serial port number 1 = 1 hex) | Set 8C hex in the control data C+3 bits 00 to 07 (send destination unit address) of CMND(490).<br>(Alternatively, set 13 hex in the control data C+3 bits 00 to 07 (send destination unit address) and set 1 hex in C+2 bits 08 to 11 (serial port number).) |

• Modbus-RTU Settings

Command Frame

| Item   | Set value | Setting location  |
|--|-----------|---|
| FINS command code: Converting to Modbus-RTU = 2804 hex   | 2804 hex  | Set 2804 hex in controller data s of the CMND(490) instruction.   |
| Modbus slave address (e.g., 02 hex)  | 02 hex    | Set 0210 hex in controller data s+1 of the CMND(490) instruction. |
| FUNCTION code: DATA WRITE = 10 hex   | 10 hex    |   |
| Write data register No. (e.g., frequency reference = 0002 hex)   | 0002 hex  | Set 0002 hex in controller data s+2 of CMND(490).                 |
| Number of write data registers (e.g, 1 register)   | 0001 hex  | Set 0001 hex in controller data s+3 of CMND(490).                 |
| Number of attached data registers<br>Note: Set 02 hex of this value in the leftmost byte of S+4. Set 00 hex as the leftmost register No. in the rightmost byte of S+4. | 0200 hex  | Set 0200 hex in controller data s+4 of CMND(490).                 |
| Register No. 0002 hex data (e.g., 0064 hex)<br>Note: Set 64 hex as the rightmost register No. in the leftmost byte of S+5.   | 6400 hex  | Set 6400 hex in controller data s+5 of CMND(490).                 |

Response Frame

| Item   | Setting  | Setting location           |
|--|----------|----------------------------|
| Modbus Slave address (e.g., 02 hex)                            | 02 hex   | Stored in D+2 of CMND(490) |
| FUNCTION code: Write data (= 10 hex)                           | 10 hex   |                            |
| Write data register No. (e.g., frequency reference = 0002 hex) | 0002 hex | Stored in D+3 of CMND(490) |
| Write data registers (e.g., 1 register)                        | 0001 hex | Stored in D+4 of CMND(490) |

[CMND S D C]

Command Details

| Operand      | Offset | Value     | Meaning   |
|--------------|--------|-----------|---|
| S:<br>D01000 | +0:    | 2804 hex  | Conversion to Modbus-RTU (FINS command code: 2804 hex)  |
|              | +1:    | 0210 hex  | Modbus-RTU slave address: 02 hex, FUNCTION code: 10 hex (DATA WRITE)  |
|              | +2:    | 0002 hex  | Write data register No.: 0002 hex (frequency reference)   |
|              | +3:    | 0001 hex  | Number of write data registers: 0001 hex (1 register)   |
|              | +4:    | 0200 hex  | Number of attached data bytes: 02 hex (2 bytes); Leftmost register No.: 00 hex                                      |
|              | +5:    | 6400 hex  | Rightmost register No.: 64 hex (Frequency reference value: 10.0 Hz when unit is 0.1 Hz), blank = 00 hex             |
| D:<br>D02000 |        |           | First response storage word   |
| C:<br>D00000 | +0:    | 00 0C hex | Number of command data bytes: 000C hex (12 bytes decimal)   |
|              | +1:    | 00 0A hex | Number of response data bytes: 000A hex (10 bytes decimal)  |
|              | +2:    | 0002 hex  | Send destination network address: 02 hex; Serial port number: 0 hex (direct serial port unit address specification) |
|              | +3:    | 058C hex  | Send destination node address: 05 hex; Send destination unit address: 8C hex  |
|              | +4:    | 0000 hex  | Response required; Communications port number: 0; Resends: 0 hex  |
|              | +5:    | 0000 hex  | Response monitoring time: 2 s   |

Response

| Operand      | Offset | Value    | Meaning  |
|--------------|--------|----------|--|
| D:<br>D02000 | +0:    | 2804 hex | Conversion to Modbus-RTU (FINS command code: 2804 hex)               |
|              | +1:    | 0000 hex | FINS end code: 0000 hex (normal)                                     |
|              | +2:    | 0210 hex | Modbus-RTU slave address: 02 hex, FUNCTION code: 10 hex (DATA WRITE) |
|              | +3:    | 0002 hex | Write data register No.: 0002 hex (frequency reference)              |
|              | +4:    | 0001 hex | Number of write data registers: 0001 hex (1 register)                |

**Sending Host Link FINS Commands**

- Set any FINS command code in S.
- Be sure to set the Host Link unit number (0 to 31) incremented by one (1 to 32) for the PLC slave corresponding to the send destination node address in C+3 bits 08 to 15.

**Example of Sending Host Link FINS Commands Using CMND(490)**

The following example is for sending FINS commands to a CS/CJ/CP-series PLC or an NSJ Controller connected to the Serial Communications Unit through an RS-422A/485 communications path via an Ethernet network.

Example: The CMND(490) instruction is executed in the PLC on the Ethernet. The FINS command (e.g., OPERATING MODE CHANGE STOP: 0402 hex) is sent to the CS/CJ/CP-series PLC or NSJ Controller (Host Link unit number = 1) that is connected to port 2 (unit address = 81 hex + 4 hex × unit number 6 = 99 hex = 153 decimal, corresponding to network address 5 in the routing tables) of the Serial Communications Unit (unit number 6) that is connected to the PLC on the Ethernet. Routing is performed between the networks, so use the setting for routing tables.

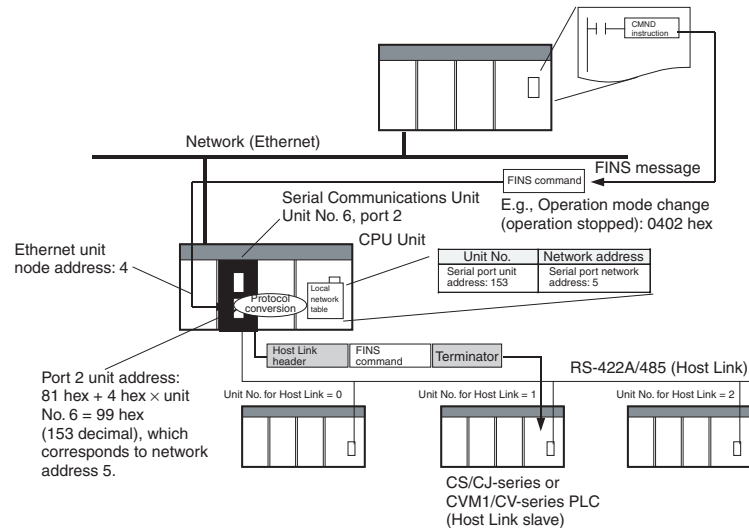

**Settings**

• FINS Network Settings

| Item  | Value (example)   | Setting location   |             |                 |  |  |
|---|---|--|-------------|-----------------|--|--|
| Send destination network address<br>(network address allocated to target serial port in routing tables) | Network address for serial communications path allocated in local network table settings is 5 | <ul style="list-style-type: none"> <li>Set 05 hex in bits 00 to 07 (network address) of control data C+2 in the CMND(490) instruction.</li> <li><b>Note</b> Set 0 hex in bits 08 to 11 (serial port number) of control data C+2 in the CMND(490) instruction</li> </ul>  |             |                 |  |  |
| Send destination node address<br>(unit number for Host Link of PLC connected to target serial port + 1) | Remote PLC unit number for Host Link: 1<br>Therefore, set 1+1 = 2                             | <ul style="list-style-type: none"> <li>Set 02 hex in bits 08 to 15 (send destination node address) of control data C+3 in the CMND(490) instruction.</li> </ul>  |             |                 |  |  |
| Send destination unit address<br>(unit address of remote unit on PLC connected to target serial port)   | CPU Unit: 00 hex  | <ul style="list-style-type: none"> <li>Set 00 hex in bits 00 to 07 of control data C+3 in the CMND(490) instruction.</li> </ul>  |             |                 |  |  |
| Serial Communications Unit unit number  | 6   | <p>Use the following equation to calculate the unit address of the serial port.</p> $81 \text{ hex} + 4 \text{ hex} \times \text{unit number } 6 = 99 \text{ hex (153 decimal)}$ <p>Use CX-Net to set the local network tables in the routing tables.</p> <table border="1" style="margin-left: auto; margin-right: auto;"> <thead> <tr> <th>Unit number</th> <th>Network address</th> </tr> </thead> <tbody> <tr> <td>Serial Communications Unit's serial port unit address: 153 (decimal)</td> <td>Serial port network address: 5 (decimal)</td> </tr> </tbody> </table> | Unit number | Network address | Serial Communications Unit's serial port unit address: 153 (decimal) | Serial port network address: 5 (decimal) |
| Unit number   | Network address   |  |             |                 |  |  |
| Serial Communications Unit's serial port unit address: 153 (decimal)                                    | Serial port network address: 5 (decimal)  |  |             |                 |  |  |
| Serial Communications Unit serial port  | Port 2  |  |             |                 |  |  |

• Host Link FINS Settings

Command Frame

| Item  | Setting  | Setting location  |
|---|----------|---|
| FINS command code (e.g., change operating mode (stop operation))        | 0402 hex | Set in 0402 hex of control data S for CMND(490) instruction   |
| FINS command parameter (e.g., always FFFF hex to change operating mode) | FFFF hex | Set in FFFF hex of control data s+1 for CMND(490) instruction |

Response Frame

| Item   | Setting  | Setting location                       |
|--|----------|--|
| FINS command code (E.g., change operating mode (stop operation)) | 0402 hex | Stored in D of CMND(490) instruction   |
| FINS command end code (normal end: 0000 hex)                     | 0000 hex | Stored in D+1 of CMND(490) instruction |

[CMND S D C]

**Command Details**

| Operand   | Offset | Value    | Meaning  |
|-----------|--------|----------|--|
| S: D01000 | +0:    | 0402 hex | Change operating mode (stop operation) (FINS command code: 0402 hex)   |
|           | +1:    | FFFF hex | Change operating mode (stop operation): Always FFFF hex  |
| D: D02000 |        |          | First response storage word  |
| C: D00000 | +0:    | 000C hex | Command data bytes: 0004 hex (4 bytes decimal)   |
|           | +1:    | 000A hex | Response data bytes: 0004 hex (4 bytes decimal)  |
|           | +2:    | 0005 hex | Send destination network address: 05 hex; Serial port number: 0 hex (not used)                                       |
|           | +3:    | 0200 hex | Send destination node address: 02 hex (set the unit number for Host Link + 1); Send destination unit address: 00 hex |
|           | +4:    | 0000 hex | Response required; Communications port number: 0; Resends: 0 hex   |
|           | +5:    | 0000 hex | Response monitoring time: 2 s  |

**Response**

| Operand   | Offset | Value    | Meaning  |
|-----------|--------|----------|--|
| D: D02000 | +0:    | 0402 hex | Change operating mode (stop operation) (FINS command code: 0402 hex) |
|           | +1:    | FFFF hex | FINS end code: FFFF hex (normal end)                                 |

- Note**
1. The method used to set the remote destination network address, node address, and unit address for sending data to or receiving data from the PLC connected serially via Host Link to another PLC on the network (to which the Serial Communications Board/Unit is mounted) using the SEND(090)/RECV(098) instructions is the same as for the CMND(490) instruction.
  2. When creating Host Link FINS command frames using the CMND(490) instruction, always set the unit number for Host Link incremented by one (1 to 32) for the remote destination (send destination) node address (word C+3, bits 08 to 15 of the CMND(490) instruction). Do not set the unit number of the actual Host Link slave (0 to 31). Using the Host Link unit number without incrementing by one will access the PLC with the entered Host Link unit number less one.  
 For example, specify remote PLC with Host Link unit number 2 by entering **3** for the remote destination node address. If the 2 is entered, the PLC with Host Link unit number 1 will be accessed.  
 To access a PLC on a Host Link FINS network using the Serial Gateway from CX-Programmer, however, enter the actual Host Link unit number, without incrementing by one. (Select **Change PLC**, click the **Display Serial Gateway Guide** Button, and set unit number in the **Host Link SYS-WAY Settings** field of the Serial Gateway Guide dialog box.

**Sending Modbus-ASCII Commands**

- Set the FINS command code of 2805 hex in S, indicating conversion to Modbus-RTU.
- In S+1 onwards, set the slave address (2 bytes ASCII) + FUNCTION code (2 bytes ASCII) + communications data (2 × n bytes ASCII) from leftmost bytes to rightmost bytes using ASCII.

**Sending CompoWay/F Commands**

- Set the FINS command code of 2803 hex in S, indicating conversion to CompoWay/F.
- In S+1 onwards, set the CompoWay/F node number (2 bytes ASCII) + sub-address (2 bytes ASCII) + SID (1 byte ASCII) + CompoWay/F command MRC (2 bytes ASCII) + CompoWay/F command SRC (2 bytes

ASCII) + text (2 × n bytes ASCII) from leftmost bytes to rightmost bytes using ASCII.

**Note** Set the contents of S+3 when using CompoWay/F commands as follows:  
Set the SID "0" as ASCII 30 hex (1 byte) in the leftmost byte, and the leftmost digit of the CompoWay/F command code MRC as ASCII (1 byte) in the rightmost byte. Next, set the bits of S+4 as follows:  
Set the rightmost digits of the CompoWay/F command code MRC as ASCII in the leftmost byte, and the leftmost digit of the CompoWay/F command code SRC as ASCII (1 byte) in the rightmost byte. Be sure to set one byte each for the subsequent data without any blank bytes.



# SECTION 4

## C-mode Commands

This section provides detailed descriptions of the C-mode commands.

|        |                                       |     |
|--------|---------------------------------------|-----|
| 4-1    | C-mode Command List .....             | 100 |
| 4-2    | End Codes .....                       | 103 |
| 4-3    | C-mode Command Details.....           | 105 |
| 4-3-1  | About this Section.....               | 105 |
| 4-3-2  | CIO AREA READ -- RR .....             | 106 |
| 4-3-3  | LR AREA READ -- RL.....               | 107 |
| 4-3-4  | HR AREA READ -- RH .....              | 108 |
| 4-3-5  | TIMER/COUNTER PV READ -- RC.....      | 109 |
| 4-3-6  | TIMER/COUNTER STATUS READ -- RG ..... | 110 |
| 4-3-7  | DM AREA READ -- RD.....               | 111 |
| 4-3-8  | AR AREA READ -- RJ .....              | 112 |
| 4-3-9  | EM AREA READ -- RE .....              | 113 |
| 4-3-10 | CIO AREA WRITE -- WR .....            | 114 |
| 4-3-11 | LR AREA WRITE -- WL .....             | 115 |
| 4-3-12 | HR AREA WRITE -- WH .....             | 116 |
| 4-3-13 | TIMER/COUNTER PV WRITE -- WC.....     | 117 |
| 4-3-14 | DM AREA WRITE -- WD.....              | 118 |
| 4-3-15 | AR AREA WRITE -- WJ .....             | 119 |
| 4-3-16 | EM AREA WRITE -- WE .....             | 120 |
| 4-3-17 | TIMER/COUNTER SV READ 1 -- R#.....    | 121 |
| 4-3-18 | TIMER/COUNTER SV READ 2 -- R\$.....   | 122 |
| 4-3-19 | TIMER/COUNTER SV READ 3 -- R% .....   | 124 |
| 4-3-20 | TIMER/COUNTER SV CHANGE 1 -- W#.....  | 127 |
| 4-3-21 | TIMER/COUNTER SV CHANGE 2 -- W\$..... | 128 |
| 4-3-22 | TIMER/COUNTER SV CHANGE 3 -- W% ..... | 130 |
| 4-3-23 | STATUS READ -- MS .....               | 133 |
| 4-3-24 | STATUS CHANGE -- SC .....             | 134 |
| 4-3-25 | ERROR READ -- MF .....                | 135 |
| 4-3-26 | FORCED SET -- KS .....                | 137 |
| 4-3-27 | FORCED RESET -- KR .....              | 138 |
| 4-3-28 | MULTIPLE FORCED SET/RESET -- FK ..... | 139 |
| 4-3-29 | FORCED SET/RESET CANCEL -- KC.....    | 140 |
| 4-3-30 | PLC MODEL READ -- MM .....            | 141 |
| 4-3-31 | TEST -- TS .....                      | 142 |
| 4-3-32 | PROGRAM READ -- RP.....               | 142 |
| 4-3-33 | PROGRAM WRITE -- WP .....             | 143 |
| 4-3-34 | I/O TABLE GENERATE -- MI .....        | 144 |
| 4-3-35 | REGISTER I/O MEMORY -- QQMR.....      | 145 |
| 4-3-36 | READ I/O MEMORY -- QQIR.....          | 146 |
| 4-3-37 | ABORT -- XZ .....                     | 147 |
| 4-3-38 | INITIALIZE -- **.....                 | 148 |
| 4-3-39 | Undefined Command -- IC .....         | 148 |

## 4-1 C-mode Command List

The following table lists the C-mode commands (Host Link commands).

| Type                     | Header code | Name                      | Function  |
|--------------------------|-------------|---------------------------|---|
| I/O memory reading       | RR          | CIO AREA READ             | Reads the specified number of words beginning with the designated CIO word.   |
|                          | RL          | LR AREA READ              | Reads the specified number of words beginning with the designated LR word.  |
|                          | RH          | HR AREA READ              | Reads the specified number of words beginning with the designated HR word.  |
|                          | RC          | TIMER/COUNTER PV READ     | Reads the specified number of words of the timer/counter PV beginning with the designated word.   |
|                          | RG          | TIMER/COUNTER STATUS READ | Reads the specified number of words of the timer/counter status beginning with the designated word.   |
|                          | RD          | DM AREA READ              | Reads the specified number of words beginning with the designated DM word.  |
|                          | RJ          | AR AREA READ              | Reads the specified number of words beginning with the designated AR word.  |
|                          | RE          | EM AREA READ              | Reads the specified number of words beginning with the designated EM word.  |
| I/O memory writing       | WR          | CIO AREA WRITE            | Writes the specified data in word units beginning with the designated CIO word.   |
|                          | WL          | LR AREA WRITE             | Writes the specified data in word units beginning with the designated LR word.  |
|                          | WH          | HR AREA WRITE             | Writes the specified data in word units beginning with the designated HR word.  |
|                          | WC          | TIMER/COUNTER PV WRITE    | Writes the specified timer/counter PV data in word units beginning with the designated word.  |
|                          | WD          | DM AREA WRITE             | Writes the specified data in word units beginning with the designated DM word.  |
|                          | WJ          | AR AREA WRITE             | Writes the specified data in word units beginning with the designated AR word.  |
|                          | WE          | EM AREA WRITE             | Writes the specified data in word units beginning with the designated EM word.  |
| Timer/counter SV reading | R#          | TIMER/COUNTER SV READ 1   | Reads in four digits BCD the constant SV that is written as an operand of the designated timer/counter instruction.   |
|                          | R\$         | TIMER/COUNTER SV READ 2   | Finds the specified timer/counter instruction, beginning with the designated program address, and reads the constant SV in four digits or the word in which the SV is stored.       |
|                          | R%          | TIMER/COUNTER SV READ 3   | Finds the specified timer/counter instruction, beginning with the designated program address, and reads the constant SV in four digits (BCD) or the word in which the SV is stored. |

| Type                                     | Header code | Name                              | Function   |
|--|-------------|-----------------------------------|--|
| Timer/counter SV changing                | W#          | TIMER/COUNTER SV CHANGE 1         | Changes the SV (timer/counter number S) of the specified timer/counter instruction to a new constant SV.   |
|  | W\$         | TIMER/COUNTER SV CHANGE 2         | Finds the specified timer/counter instruction, beginning with the designated program address in the user program, and changes the constant SV in four digits (BCD) or the word in which the SV is stored to a new constant SV or storage word. |
|  | W%          | TIMER/COUNTER SV CHANGE 3         | Finds the specified timer/counter instruction, beginning with the designated program address in the user program, and changes the constant SV in four digits (BCD) or the word in which the SV is stored to a new constant SV or storage word. |
| CPU Unit status                          | MS          | STATUS READ                       | Reads the CPU Unit's operating conditions (operating mode, forced set/reset status, and fatal errors).   |
|  | SC          | STATUS CHANGE                     | Changes the CPU Unit's operating mode.   |
|  | MF          | ERROR READ                        | Reads the CPU Unit's error information (i.e., all fatal or non-fatal errors currently in effect).  |
| Forced set/reset                         | KS          | FORCED SET                        | Forcibly sets one designated bit.  |
|  | KR          | FORCED RESET                      | Forcibly resets one designated bit.  |
|  | FK          | MULTIPLE FORCED SET/RESET         | Forcibly sets/resets/cancels multiple designated bits.   |
|  | KC          | FORCED SET/RESET CANCEL           | Cancels all forced set/reset status.   |
| PLC model code reading                   | MM          | PLC MODEL READ                    | Reads the model code of the CPU Unit.  |
| Testing                                  | TS          | TEST                              | Returns, just as it is, a single block that was sent from the host computer.   |
| Program area accessing                   | RP          | PROGRAM READ                      | Reads, in one batch, the contents of the CPU Unit's user program at the machine language (object) level.   |
|  | WP          | PROGRAM WRITE                     | Writes into the CPU Unit's user program area the machine language (object) sent from the host computer.  |
| I/O table creation                       | MI          | I/O TABLE CREATE                  | Creates an I/O table with the contents of the actual I/O configuration.  |
| I/O memory area registration and reading | QQMR        | REGISTER I/O MEMORY               | Registers the I/O memory words or bits that are to be read.  |
|  | QQIR        | READ I/O MEMORY                   | Reads the registered I/O memory words/bits all at once.  |
| Host Link communications processing      | XZ          | ABORT (command only)              | Aborts the operation being performed by a Host Link command, and then returns to the initial status.   |
|  | **          | INITIALIZE (command only)         | Initializes the transfer control procedures for all Host Link Units.   |
|  | IC          | Undefined command (response only) | This is the response when the command header code cannot be decoded.   |

## C-mode Command Force Conditions

| Header code | Name                      | Single-frame command | Multiple-frame command | Single-frame response | Multiple-frame response | RUN       | MON   | PRG   | UM write protect | UM read protect |
|-------------|---------------------------|----------------------|------------------------|-----------------------|-------------------------|-----------|-------|-------|------------------|-----------------|
| RR          | CIO AREA READ             | Valid                | Not valid              | Valid                 | Valid                   | Valid     | Valid | Valid | Valid            | Valid           |
| RL          | LR AREA READ              | Valid                | Not valid              | Valid                 | Valid                   | Valid     | Valid | Valid | Valid            | Valid           |
| RH          | HR AREA READ              | Valid                | Not valid              | Valid                 | Valid                   | Valid     | Valid | Valid | Valid            | Valid           |
| RC          | PV READ                   | Valid                | Not valid              | Valid                 | Valid                   | Valid     | Valid | Valid | Valid            | Valid           |
| RG          | TC STATUS READ            | Valid                | Not valid              | Valid                 | Valid                   | Valid     | Valid | Valid | Valid            | Valid           |
| RD          | DM AREA READ              | Valid                | Not valid              | Valid                 | Valid                   | Valid     | Valid | Valid | Valid            | Valid           |
| RJ          | AR AREA READ              | Valid                | Not valid              | Valid                 | Valid                   | Valid     | Valid | Valid | Valid            | Valid           |
| RE          | EM AREA READ              | Valid                | Not valid              | Valid                 | Valid                   | Valid     | Valid | Valid | Valid            | Valid           |
| WR          | CIO AREA WRITE            | Valid                | Valid                  | Valid                 | Not valid               | Not valid | Valid | Valid | Valid            | Valid           |
| WL          | LR AREA WRITE             | Valid                | Valid                  | Valid                 | Not valid               | Not valid | Valid | Valid | Valid            | Valid           |
| WH          | HR AREA WRITE             | Valid                | Valid                  | Valid                 | Not valid               | Not valid | Valid | Valid | Valid            | Valid           |
| WC          | PV WRITE                  | Valid                | Valid                  | Valid                 | Not valid               | Not valid | Valid | Valid | Valid            | Valid           |
| WD          | DM AREA WRITE             | Valid                | Valid                  | Valid                 | Not valid               | Not valid | Valid | Valid | Valid            | Valid           |
| WJ          | AR AREA WRITE             | Valid                | Valid                  | Valid                 | Not valid               | Not valid | Valid | Valid | Valid            | Valid           |
| WE          | EM AREA WRITE             | Valid                | Valid                  | Valid                 | Not valid               | Not valid | Valid | Valid | Valid            | Valid           |
| R#          | SV READ 1                 | Valid                | Not valid              | Valid                 | Not valid               | Valid     | Valid | Valid | Valid            | Not valid       |
| R\$         | SV READ 2                 | Valid                | Not valid              | Valid                 | Not valid               | Valid     | Valid | Valid | Valid            | Not valid       |
| R%          | SV READ 3                 | Valid                | Not valid              | Valid                 | Not valid               | Valid     | Valid | Valid | Valid            | Not valid       |
| W#          | SV CHANGE 1               | Valid                | Not valid              | Valid                 | Not valid               | Not valid | Valid | Valid | Not valid        | Not valid       |
| W\$         | SV CHANGE 2               | Valid                | Not valid              | Valid                 | Not valid               | Not valid | Valid | Valid | Not valid        | Not valid       |
| W%          | SV CHANGE 3               | Valid                | Not valid              | Valid                 | Not valid               | Not valid | Valid | Valid | Not valid        | Not valid       |
| MS          | STATUS READ               | Valid                | Not valid              | Valid                 | Not valid               | Valid     | Valid | Valid | Valid            | Valid           |
| SC          | STATUS CHANGE             | Valid                | Not valid              | Valid                 | Not valid               | Valid     | Valid | Valid | Valid            | Valid           |
| MF          | ERROR READ                | Valid                | Not valid              | Valid                 | Not valid               | Valid     | Valid | Valid | Valid            | Valid           |
| KS          | FORCED SET                | Valid                | Not valid              | Valid                 | Not valid               | Not valid | Valid | Valid | Valid            | Valid           |
| KR          | FORCED RESET              | Valid                | Not valid              | Valid                 | Not valid               | Not valid | Valid | Valid | Valid            | Valid           |
| FK          | MULTIPLE FORCED SET/RESET | Valid                | Not valid              | Valid                 | Not valid               | Not valid | Valid | Valid | Valid            | Valid           |
| KC          | FORCED SET/RESET CANCEL   | Valid                | Not valid              | Valid                 | Not valid               | Not valid | Valid | Valid | Valid            | Valid           |
| MM          | PLC MODEL READ            | Valid                | Not valid              | Valid                 | Not valid               | Valid     | Valid | Valid | Valid            | Valid           |
| TS          | TEST                      | Valid                | Not valid              | Valid                 | Not valid               | Valid     | Valid | Valid | Valid            | Valid           |
| RP          | PROGRAM READ              | Valid                | Not valid              | Valid                 | Valid                   | Valid     | Valid | Valid | Valid            | Not valid       |

| Header code | Name                              | Single-frame command | Multiple-frame command | Single-frame response | Multiple-frame response | RUN       | MON       | PRG   | UM write protect | UM read protect |
|-------------|-----------------------------------|----------------------|------------------------|-----------------------|-------------------------|-----------|-----------|-------|------------------|-----------------|
| WP          | PROGRAM WRITE                     | Valid                | Valid                  | Valid                 | Not valid               | Not valid | Not valid | Valid | Not valid        | Valid           |
| MI          | I/O TABLE GENERATE                | Valid                | Not valid              | Valid                 | Not valid               | Not valid | Not valid | Valid | Not valid        | Valid           |
| QQMR        | READ I/O MEMORY                   | Valid                | Valid                  | Valid                 | Not valid               | Valid     | Valid     | Valid | Valid            | Valid           |
| QQIR        | REGISTER I/O MEMORY               | Valid                | Not valid              | Valid                 | Valid                   | Valid     | Valid     | Valid | Valid            | Valid           |
| XZ          | ABORT (command only)              | Valid                | Valid                  | Valid                 | Valid                   | Valid     | Valid     | Valid | Valid            | Valid           |
| **          | INITIALIZE (command only)         | Valid                | Valid                  | Valid                 | Valid                   | Valid     | Valid     | Valid | Valid            | Valid           |
| IC          | Undefined command (response only) | Valid                | Valid                  | Valid                 | Valid                   | Valid     | Valid     | Valid | Valid            | Valid           |

## 4-2 End Codes

### End Code Summary

These are the response (end) codes that are returned in the response frame. When two or more errors occur, the end code for the first error will be returned.

| End code | Contents                       | Probable cause  | Corrective measures  |
|----------|--------------------------------|---|--|
| 00       | Normal completion              | No problem exists.  | ---  |
| 01       | Not executable in RUN mode     | The command that was sent cannot be executed when the PLC is in RUN mode.   | Check the relation between the command and the PLC mode.   |
| 02       | Not executable in MONITOR mode | The command that was sent cannot be executed when the PLC is in MONITOR mode.   |  |
| 03       | UM write-protected             | The PLC's UM is write-protected.  | Turn OFF pin 1 of the CPU Unit's DIP switch (SW1).   |
| 04       | Address over                   | The program address setting in an read or write command is above the highest program address.   | Check the program.   |
| 0B       | Not executable in PROGRAM mode | The command that was sent cannot be executed when the PLC is in PROGRAM mode.   | This code is not currently used.   |
| 13       | FCS error                      | The FCS is wrong.   | Check the FCS calculation method. If there was influence from noise, transfer the command again. |
| 14       | Format error                   | The command format is wrong, or a command that cannot be divided has been divided, or the frame length is smaller than the minimum length for the applicable command. | Check the format and transfer the command again.   |
| 15       | Entry number data error        | The data is outside of the specified range or too long.<br>Hexadecimal data has not been specified.   | Correct the data and transfer the command again.   |
| 16       | Command not supported          | The operand specified in an SV Read or SV Change command does not exist in the program.   | Check search data or the search starting point.  |

| End code | Contents  | Probable cause   | Corrective measures   |
|----------|---|--|---|
| 18       | Frame length error  | The maximum frame length of 131 bytes was exceeded.<br>(If the frame exceeds 280 bytes, the Reception Overflow Flag will be turned ON and there will not be a response.) | Check the command and divide it into multiple frames if necessary.  |
| 19       | Not executable  | The read SV exceeded 9,999, or an I/O memory batch read was executed when items to read were not registered for composite command, or access right was not obtained.     | Register items to read before attempting batch read, or obtain access right.  |
| 20       | Could not create I/O table                                  | Unrecognized Remote I/O Unit, too many I/O words, or word duplication used.  | Check the Remote I/O System, the number of I/O words, and the words used.   |
| 21       | Not executable due to CPU Unit CPU error (See note.)        | The command cannot be executed because a CPU error has occurred in the CPU Unit.   | Cycle the CPU Unit's power supply.  |
| 23       | User memory protected                                       | The UM is read-protected or write-protected.   | Clear write-protection by setting pin 1 of the DIP switch on the front of the CPU Unit to OFF. Alternatively, clear the CPU Unit's password-protection using CX-Programmer. |
| A3       | Aborted due to FCS error in transmission data               | An FCS error occurred in the second or later frame, or there were two bytes or less of data in an intermediate or final frame for multiple writing.                      | Correct the command data and transfer the command again.  |
| A4       | Aborted due to format error in transmission data            | The command format did not match the number of bytes in the second or later frame.   |   |
| A5       | Aborted due to entry number data error in transmission data | There was an entry number data error in the second or later frame, a data length error, or data was not set in hexadecimal.  |   |
| A8       | Aborted due to frame length error in transmission data      | The length of the second and later frames exceeded the maximum of 128 bytes.   |   |

**Note** Occurs only for a Serial Communications Unit/Board.

A response will not be received with some errors, regardless of the command. These errors are listed in the following table.

| Error  | PLC operation  |
|--|--|
| A command is received with eight bytes or less from the @ to the delimiter.                                  | The initial command (4 bytes) executes the initial processing. Other commands are discarded.   |
| Parity, overrun, or framing error during command reception. (Same even for commands address to other Units.) | The Communications Error Flag will be turned ON, an error code will be registered, and receptions will be reset. (The error will be cleared automatically if communications restart normally.) |
| A command is received that does not have the @ character at the beginning of the first frame.                | The command is discarded.  |
| Incorrect node number (Not a local unit, BCD, or over 31)  | The command is discarded.  |
| An LF code is received after the delimiter.  | The LF code is discarded.  |

**Command/End Code Table** The following table shows which end codes can be returned for each C-mode command.

| Header | Possible End Codes |    |    |    |    |    |     |    |    |    | Comments |    |     |    |             |
|--------|--------------------|----|----|----|----|----|-----|----|----|----|----------|----|-----|----|-------------|
| RR     | 00                 |    |    | 13 | 14 | 15 | 18  | 21 |    |    | ---      |    |     |    |             |
| RL     | 00                 |    |    | 13 | 14 | 15 | 18  | 21 |    |    | ---      |    |     |    |             |
| RH     | 00                 |    |    | 13 | 14 | 15 | 18  | 21 |    |    | ---      |    |     |    |             |
| RC     | 00                 |    |    | 13 | 14 | 15 | 18  | 21 |    |    | ---      |    |     |    |             |
| RG     | 00                 |    |    | 13 | 14 | 15 | 18  | 21 |    |    | ---      |    |     |    |             |
| RD     | 00                 |    |    | 13 | 14 | 15 | 18  | 21 |    |    | ---      |    |     |    |             |
| RJ     | 00                 |    |    | 13 | 14 | 15 | 18  | 21 |    |    | ---      |    |     |    |             |
| RE     | 00                 |    |    | 13 | 14 | 15 | 18  | 21 |    |    | ---      |    |     |    |             |
| WR     | 00                 | 01 |    | 13 | 14 | 15 | 18  | 21 | A3 | A4 | A5       | A8 | --- |    |             |
| WL     | 00                 | 01 |    | 13 | 14 | 15 | 18  | 21 | A3 | A4 | A5       | A8 | --- |    |             |
| WH     | 00                 | 01 |    | 13 | 14 | 15 | 18  | 21 | A3 | A4 | A5       | A8 | --- |    |             |
| WC     | 00                 | 01 |    | 13 | 14 | 15 | 18  | 21 | A3 | A4 | A5       | A8 | --- |    |             |
| WD     | 00                 | 01 |    | 13 | 14 | 15 | 18  | 27 | A3 | A4 | A5       | A8 | --- |    |             |
| WJ     | 00                 | 01 |    | 13 | 14 | 15 | 18  | 21 | A3 | A4 | A5       | A8 | --- |    |             |
| WE     | 00                 | 01 |    | 13 | 14 | 15 | 18  | 21 | A3 | A4 | A5       | A8 | --- |    |             |
| R#     | 00                 |    |    | 13 | 14 | 15 | 16  | 18 | 21 | 23 |          |    | --- |    |             |
| R\$    | 00                 |    | 04 | 13 | 14 | 15 | 16  | 18 | 21 | 23 |          |    | --- |    |             |
| R%     | 00                 |    | 04 | 13 | 14 | 15 | 16  | 18 | 21 | 23 |          |    | --- |    |             |
| W#     | 00                 | 01 | 04 | 13 | 14 | 15 | 16  | 18 | 19 | 21 | 23       |    | --- |    |             |
| W\$    | 00                 | 01 | 04 | 13 | 14 | 15 | 16  | 18 | 19 | 21 | 23       |    | --- |    |             |
| W%     | 00                 | 01 | 04 | 13 | 14 | 15 | 16  | 18 | 19 | 21 | 23       |    | --- |    |             |
| MS     | 00                 |    |    | 13 | 14 |    | 18  | 21 |    |    |          |    | --- |    |             |
| SC     | 00                 |    |    | 13 | 14 | 15 | 18  | 19 | 21 |    |          |    | --- |    |             |
| MF     | 00                 | 01 | 02 | 13 | 14 | 15 | 18  | 19 | 21 |    |          |    | --- |    |             |
| KS     | 00                 | 01 |    | 13 | 14 | 15 | 18  | 21 |    |    |          |    | --- |    |             |
| KR     | 00                 | 01 |    | 13 | 14 | 15 | 18  | 21 |    |    |          |    | --- |    |             |
| FK     | 00                 | 01 |    | 13 | 14 | 15 | 18  | 21 |    |    |          |    | --- |    |             |
| KC     | 00                 | 01 |    | 13 | 14 | 15 | 18  | 21 |    |    |          |    | --- |    |             |
| MM     | 00                 |    |    | 13 | 14 |    | 18  | 21 |    |    |          |    | --- |    |             |
| TS     |                    |    |    | 13 | 14 |    | 18  | 21 |    |    |          |    | --- |    |             |
| RP     | 00                 |    |    | 13 | 14 |    | 18  | 19 | 21 | 23 |          |    | --- |    |             |
| WP     | 00                 | 01 | 02 | 13 | 14 | 15 | 18  | 19 | 21 | 23 | A3       | A4 | A5  | A8 | ---         |
| MI     | 00                 | 01 | 02 | 03 | 13 | 14 |     | 18 | 19 | 20 |          |    |     |    | ---         |
| QQMR   | 00                 |    |    | 13 | 14 | 15 | 18  | 21 |    |    | A3       | A4 | A5  | A8 | ---         |
| QQIR   | 00                 |    |    | 13 | 14 |    | 18  | 19 |    |    |          |    |     |    | ---         |
| XZ     |                    |    |    |    |    |    | --- |    |    |    |          |    |     |    | No response |
| **     |                    |    |    |    |    |    | --- |    |    |    |          |    |     |    | No response |
| IC     |                    |    |    |    |    |    | --- |    |    |    |          |    |     |    | No end code |

## 4-3 C-mode Command Details

### 4-3-1 About this Section

With C-mode command and response formats, a single character is indicated by a single box. Each character is sent and received as a single byte in ASCII.

#### Execution Conditions

The *Execution Conditions* table at the beginning of the description of each command provides the following information.

**Commands, Single**

Single command frames are used when there are 131 characters or less.

**Commands, Multiple**

Tells whether the command can be spit into multiple frames when there are more than 131 characters.

**Responses, Single**

Single response frames are used when there are 131 characters or less.

**Responses, Multiple**

Tells whether the response can be spit into multiple frames when there are more than 131 characters.

**PLC Modes, RUN**

Tells if the CPU Unit will accept the command when the CPU Unit is in RUN mode.

**PLC Modes, MONITOR**

Tells if the CPU Unit will accept the command when the CPU Unit is in MONITOR mode.

**PLC Modes, PROGRAM**

Tells if the CPU Unit will accept the command when the CPU Unit is in PROGRAM mode.

**UM Area, Write-protected**

Tells if the CPU Unit will accept the command when the UM Area is write-protected using the DIP switch on the CPU Unit.

**UM Area, Read-protected**

Tells if the CPU Unit will accept the command when the UM Area is read-protected using a Programming Device.

- Note**
1. WR Area words cannot be read or written using C-mode commands.
  2. Timers 2048 to 4095 and counters 2048 to 4095 cannot be read or written and their SV cannot be read or written using C-mode commands.
  3. D10000 to D32767 and E10000 to E32767 cannot be read or written using C-mode commands.
  4. SV can be read and written only in cyclic task 0. Also, timer SV can be read and written only when the timer number is not indirectly addressed.

**4-3-2 CIO AREA READ -- RR**

Reads the contents of the specified number of CIO words starting from the specified word.

**Command Format**

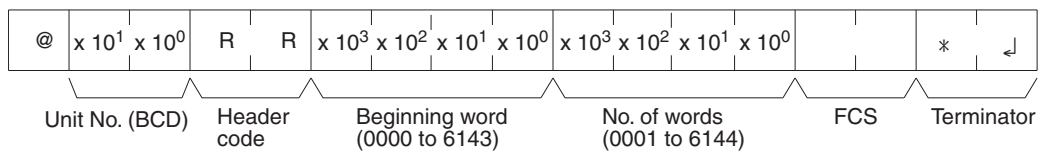

**Response Format**

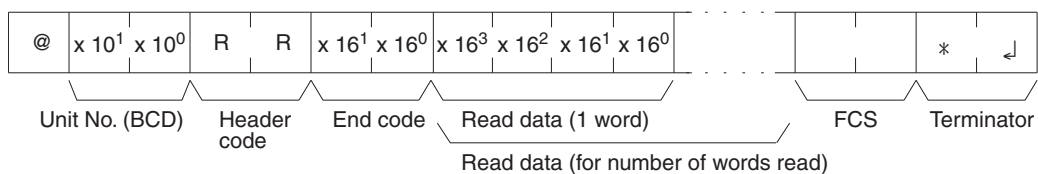



**Limitations**

The text portion of the response's first frame can contain up to 30 words. If more than 30 words are read, the data will be returned in multiple frames.

In the second and later frames, the text portion of the response can contain up to 31 words.

The INITIALIZE and ABORT commands can be sent instead of the delimiter for multiple responses for this command. If other commands are sent, they will be treated as delimiters.

**Execution Conditions**

| Commands |          | Responses |          | PLC Mode |     |      | UM Area         |                |
|----------|----------|-----------|----------|----------|-----|------|-----------------|----------------|
| Single   | Multiple | Single    | Multiple | RUN      | MON | PROG | Write-protected | Read-protected |
| OK       | No       | OK        | OK       | OK       | OK  | OK   | OK              | OK             |

**End Codes**

An end code of 14 (format error) will be returned if the length of the command is incorrect and an end code of 15 (entry number data error) will be returned if the specified words exceed the data area boundaries, or are not specified in BCD, or if the number of words to read is 0.

| End code (Hex) | Contents                                  |
|----------------|---|
| 00             | Normal completion                         |
| 13             | FCS error                                 |
| 14             | Format error                              |
| 15             | Entry number data error                   |
| 18             | Frame length error                        |
| 21             | Not executable due to CPU Unit CPU error. |

**4-3-3 LR AREA READ -- RL**

Treats CIO 1000 to CIO 1199 as a data link area and reads the contents of the specified number of words starting from the specified word.

**Command Format**

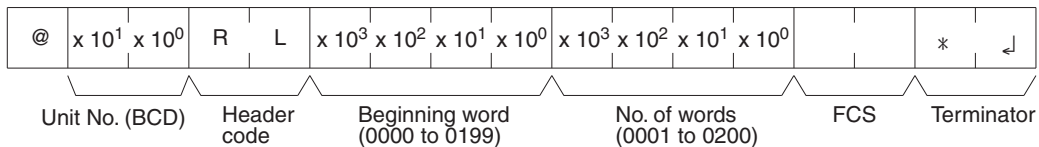

**Response Format**

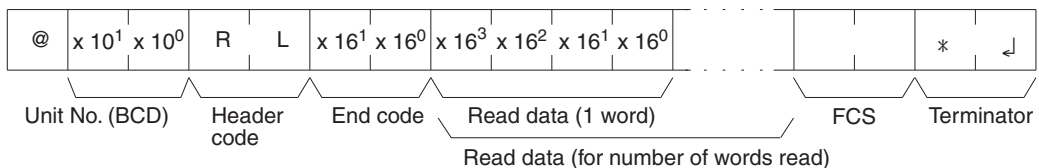

**Limitations**

The text portion of the response's first frame can contain up to 30 words. If more than 30 words are read, the data will be returned in multiple frames.

In the second and later frames, the text portion of the response can contain up to 31 words.

The INITIALIZE and ABORT commands can be sent instead of the delimiter for multiple responses for this command. If other commands are sent, they will be treated as delimiters.

**Execution Conditions**

| Commands |          | Responses |          | PLC Mode |     |      | UM Area         |                |
|----------|----------|-----------|----------|----------|-----|------|-----------------|----------------|
| Single   | Multiple | Single    | Multiple | RUN      | MON | PROG | Write-protected | Read-protected |
| OK       | No       | OK        | OK       | OK       | OK  | OK   | OK              | OK             |

**End Codes**

An end code of 14 (format error) will be returned if the length of the command is incorrect and an end code of 15 (entry number data error) will be returned if the specified words exceed the data area boundaries, or are not specified in BCD, or if the number of words to read is 0.

| End code (Hex) | Contents                                  |
|----------------|---|
| 00             | Normal completion                         |
| 13             | FCS error                                 |
| 14             | Format error                              |
| 15             | Entry number data error                   |
| 18             | Frame length error                        |
| 21             | Not executable due to CPU Unit CPU error. |

**Note** The command is provided for compatibility with previous models. We recommend using CIO AREA READ (RR) whenever possible.

**4-3-4 HR AREA READ -- RH**

Reads the contents of the specified number of HR words starting from the specified word.

**Command Format**

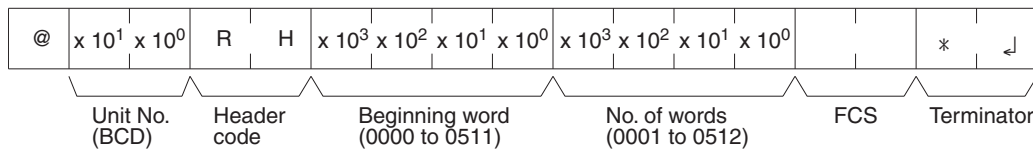

**Response Format**

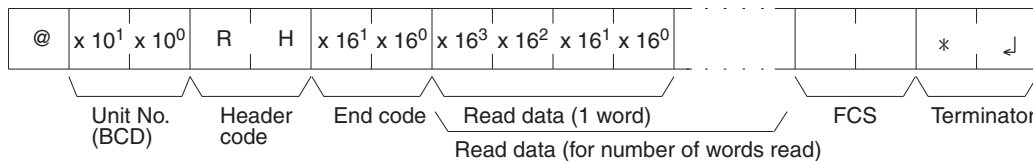

**Limitations**

The text portion of the response's first frame can contain up to 30 words. If more than 30 words are read, the data will be returned in multiple frames. In the second and later frames, the text portion of the response can contain up to 31 words. The INITIALIZE and ABORT commands can be sent instead of the delimiter for multiple responses for this command. If other commands are sent, they will be treated as delimiters.

**Execution Conditions**

| Commands |          | Responses |          | PLC Mode |     |      | UM Area         |                |
|----------|----------|-----------|----------|----------|-----|------|-----------------|----------------|
| Single   | Multiple | Single    | Multiple | RUN      | MON | PROG | Write-protected | Read-protected |
| OK       | No       | OK        | OK       | OK       | OK  | OK   | OK              | OK             |

**End Codes**

An end code of 14 (format error) will be returned if the length of the command is incorrect and an end code of 15 (entry number data error) will be returned if

the specified words exceed the data area boundaries, or are not specified in BCD, or if the number of words to read is 0.

| End code (Hex) | Contents                                  |
|----------------|---|
| 00             | Normal completion                         |
| 13             | FCS error                                 |
| 14             | Format error                              |
| 15             | Entry number data error                   |
| 18             | Frame length error                        |
| 21             | Not executable due to CPU Unit CPU error. |

### 4-3-5 TIMER/COUNTER PV READ -- RC

Reads the contents of the specified number of timer/counter PVs (present values T0000 to T2047 or C0000 to C2047) starting from the specified timer/counter.

#### Command Format

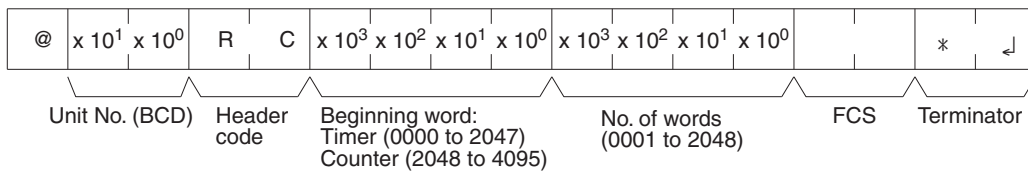

#### Response Format

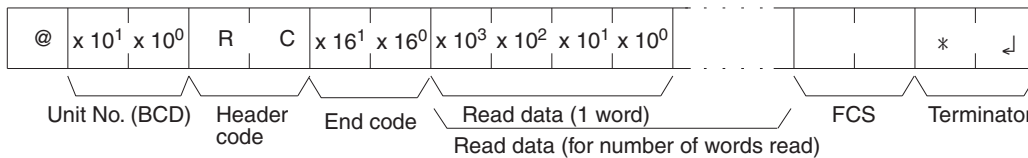

#### Limitations

The text portion of the response's first frame can contain up to 30 words. If more than 30 words are read, the data will be returned in multiple frames.

In the second and later frames, the text portion of the response can contain up to 31 words.

The INITIALIZE and ABORT commands can be sent instead of the delimiter for multiple responses for this command. If other commands are sent, they will be treated as delimiters.

Designate 0000 to 2047 for timers and 2048 to 4095 for counters (add 2048 to the actual counter number).

Timers 2048 to 4095 and counters 2048 to 4095 cannot be read.

Commands are divided among timers and counters for execution. If an attempt is made to designate across timers and counters, an end code of 15 (entry number data error) will be returned.

#### Execution Conditions

| Commands |          | Responses |          | PLC Mode |     |      | UM Area         |                |
|----------|----------|-----------|----------|----------|-----|------|-----------------|----------------|
| Single   | Multiple | Single    | Multiple | RUN      | MON | PROG | Write-protected | Read-protected |
| OK       | No       | OK        | OK       | OK       | OK  | OK   | OK              | OK             |

#### End Codes

An end code of 14 (format error) will be returned if the length of the command is incorrect and an end code of 15 (entry number data error) will be returned if

the specified words exceed the data area boundaries, or are not specified in BCD, or if the number of words to read is 0.

| End code (Hex) | Contents                                  |
|----------------|---|
| 00             | Normal completion                         |
| 13             | FCS error                                 |
| 14             | Format error                              |
| 15             | Entry number data error                   |
| 18             | Frame length error                        |
| 21             | Not executable due to CPU Unit CPU error. |

### 4-3-6 TIMER/COUNTER STATUS READ -- RG

Reads the ON/OFF status of the Completion Flags of the specified number of timers/counters starting from the designated word (T0000 to T2047 or C0000 to C2047).

#### Command Format

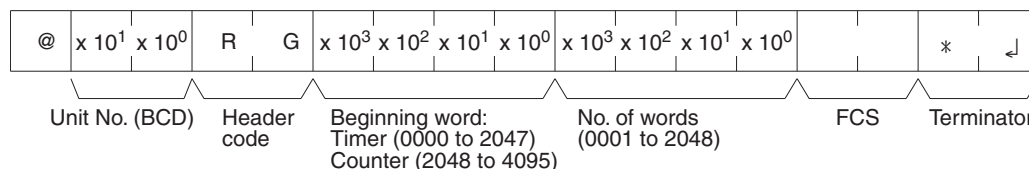

#### Response Format

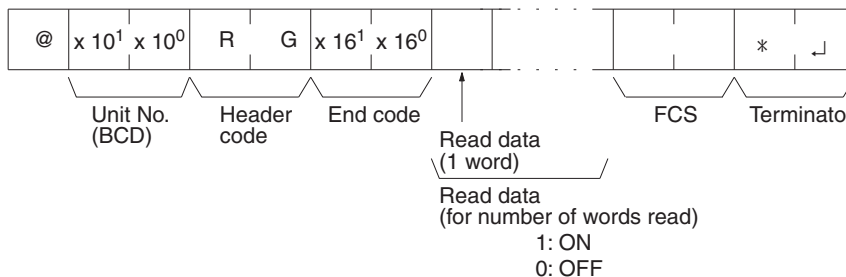

#### Limitations

The number of words per frame for response data is different to that for C-series Units. For details refer to 2-4 Precautions when Reusing Programs from Earlier Models.

The text portion of the response's first frame can contain up to 121 words. If more than 121 words are read, the data will be returned in multiple frames.

In the second and later frames, the text portion of the response can contain up to 124 words.

The INITIALIZE and ABORT commands can be sent instead of the delimiter for multiple responses for this command. If other commands are sent, they will be treated as delimiters.

Designate 0000 to 2047 for timers and 2048 to 4095 for counters (add 2048 to the actual counter number).

Timers T2048 to T4095 and counters C2048 to C4095 cannot be read.

Commands are divided with regard to timers and counters. If an attempt is made to designate across timers and counters, an end code of 15 (entry number data error) will be returned.

Execution Conditions

| Commands |          | Responses |          | PLC Mode |     |      | UM Area         |                |
|----------|----------|-----------|----------|----------|-----|------|-----------------|----------------|
| Single   | Multiple | Single    | Multiple | RUN      | MON | PROG | Write-protected | Read-protected |
| OK       | No       | OK        | OK       | OK       | OK  | OK   | OK              | OK             |

End Codes

An end code of 14 (format error) will be returned if the length of the command is incorrect and an end code of 15 (entry number data error) will be returned if the specified words exceed the data area boundaries, or are not specified in BCD, or if the number of words to read is 0.

| End code (Hex) | Contents                                  |
|----------------|---|
| 00             | Normal completion                         |
| 13             | FCS error                                 |
| 14             | Format error                              |
| 15             | Entry number data error                   |
| 18             | Frame length error                        |
| 21             | Not executable due to CPU Unit CPU error. |

4-3-7 DM AREA READ -- RD

Reads the contents of the specified number of DM words starting from the specified word (D00000 to D09999).

Command Format

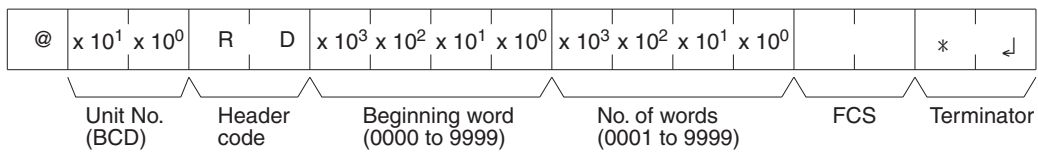

Response Format

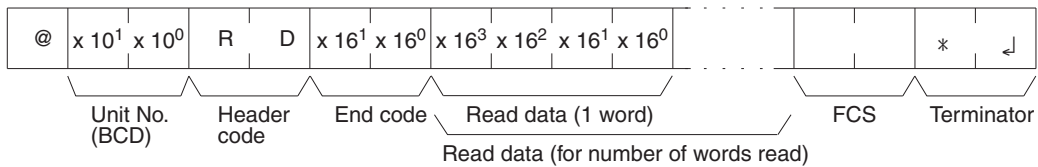

Limitations

The DM Area is comprised of D00000 to D32767, but the range that can be read by this command is D00000 to D09999.

The text portion of the response's first frame can contain up to 30 words. If more than 30 words are read, the data will be returned in multiple frames.

In the second and later frames, the text portion of the response can contain up to 31 words.

The INITIALIZE and ABORT commands can be sent instead of the delimiter for multiple responses for this command. If other commands are sent, they will be treated as delimiters.

Execution Conditions

| Commands |          | Responses |          | PLC Mode |     |      | UM Area         |                |
|----------|----------|-----------|----------|----------|-----|------|-----------------|----------------|
| Single   | Multiple | Single    | Multiple | RUN      | MON | PROG | Write-protected | Read-protected |
| OK       | No       | OK        | OK       | OK       | OK  | OK   | OK              | OK             |

End Codes

An end code of 14 (format error) will be returned if the length of the command is incorrect and an end code of 15 (entry number data error) will be returned if

the specified words exceed the data area boundaries, or are not specified in BCD, or if the number of words to read is 0.

| End code (Hex) | Contents                                  |
|----------------|---|
| 00             | Normal completion                         |
| 13             | FCS error                                 |
| 14             | Format error                              |
| 15             | Entry number data error                   |
| 18             | Frame length error                        |
| 21             | Not executable due to CPU Unit CPU error. |

### 4-3-8 AR AREA READ -- RJ

Reads the contents of the specified number of Auxiliary Area words (A000 to A959) starting from the specified word.

#### Command Format

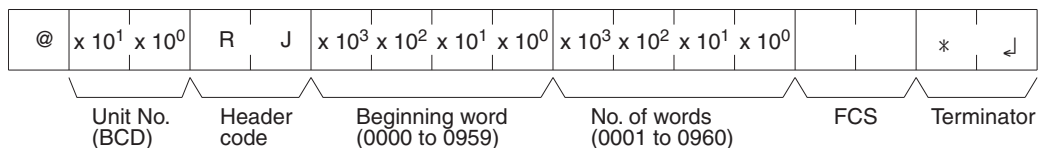

#### Response Format

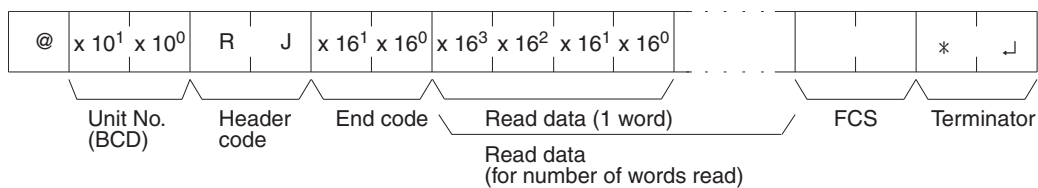

#### Limitations

The text portion of the response's first frame can contain up to 30 words. If more than 30 words are read, the data will be returned in multiple frames.

In the second and later frames, the text portion of the response can contain up to 31 words.

The INITIALIZE and ABORT commands can be sent instead of the delimiter for multiple responses for this command. If other commands are sent, they will be treated as delimiters.

#### Execution Conditions

| Commands |          | Responses |          | PLC Mode |     |      | UM Area         |                |
|----------|----------|-----------|----------|----------|-----|------|-----------------|----------------|
| Single   | Multiple | Single    | Multiple | RUN      | MON | PROG | Write-protected | Read-protected |
| OK       | No       | OK        | OK       | OK       | OK  | OK   | OK              | OK             |

#### End Codes

An end code of 14 (format error) will be returned if the length of the command is incorrect and an end code of 15 (entry number data error) will be returned if the specified words exceed the data area boundaries, or are not specified in BCD, or if the number of words to read is 0.

| End code (Hex) | Contents                                  |
|----------------|---|
| 00             | Normal completion                         |
| 13             | FCS error                                 |
| 14             | Format error                              |
| 15             | Entry number data error                   |
| 18             | Frame length error                        |
| 21             | Not executable due to CPU Unit CPU error. |

### 4-3-9 EM AREA READ -- RE

Reads the contents of the specified number of EM words (E00000 to E09999) starting from the specified word in the specified EM bank.

#### Command Format

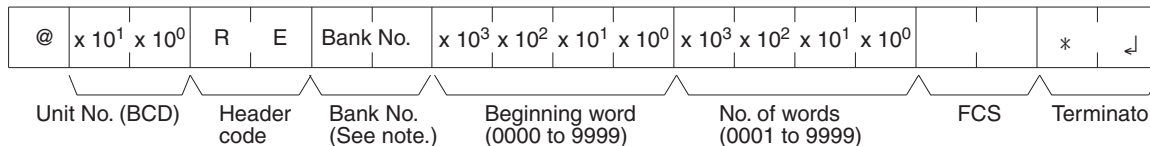

**Note** Input 00, 01, or 0C to specify bank number 0, 1, or C. Input two spaces to specify the current bank.

#### Response Format

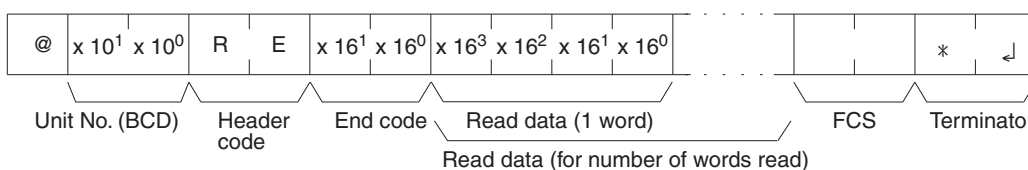

#### Limitations

A single bank of EM consists of E00000 to E32767, but the range that can be read by this command is E00000 to E09999.

The maximum EM bank number that can be specified is 12 (0C Hex).

The text portion of the response's first frame can contain up to 30 words. If more than 30 words are read, the data will be returned in multiple frames.

In the second and later frames, the text portion of the response can contain up to 31 words.

This command cannot be used to change the current bank number.

The INITIALIZE and ABORT commands can be sent instead of the delimiter for multiple responses for this command. If other commands are sent, they will be treated as delimiters.

#### Execution Conditions

| Commands |          | Responses |          | PLC Mode |     |      | UM Area         |                |
|----------|----------|-----------|----------|----------|-----|------|-----------------|----------------|
| Single   | Multiple | Single    | Multiple | RUN      | MON | PROG | Write-protected | Read-protected |
| OK       | No       | OK        | OK       | OK       | OK  | OK   | OK              | OK             |

#### End Codes

An end code of 14 (format error) will be returned if the length of the command is incorrect and an end code of 15 (entry number data error) will be returned if the specified words exceed the data area boundaries, the specified words are not specified in BCD, or an invalid bank number is specified. An end code of 15 will also be returned if there are no banks and file memory access is not possible, or if the number of words to read is 0.

| End code (Hex) | Contents                                  |
|----------------|---|
| 00             | Normal completion                         |
| 13             | FCS error                                 |
| 14             | Format error                              |
| 15             | Entry number data error                   |
| 18             | Frame length error                        |
| 21             | Not executable due to CPU Unit CPU error. |

### 4-3-10 CIO AREA WRITE -- WR

Writes data to the CIO Area (CIO 0000 to CIO 6143) starting from the specified word. Writing is done in word units.

#### Command Format

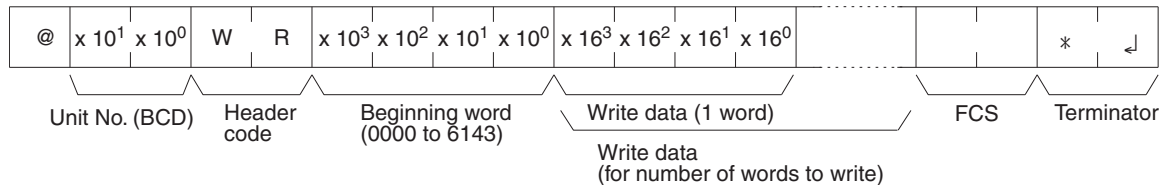

#### Response Format

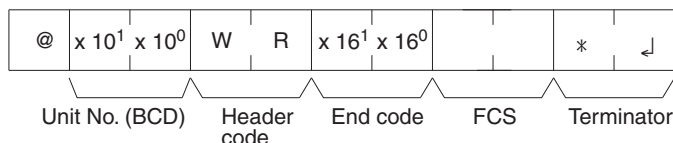

#### Execution Conditions

| Commands |          | Responses |          | PLC Mode |     |      | UM Area         |                |
|----------|----------|-----------|----------|----------|-----|------|-----------------|----------------|
| Single   | Multiple | Single    | Multiple | RUN      | MON | PROG | Write-protected | Read-protected |
| OK       | OK       | OK        | No       | No       | OK  | OK   | OK              | OK             |

#### End Codes

An end code of 14 (format error) will be returned if the length of the command is incorrect or the first word of write data is not in the first frame.

An end code of 15 (entry number data error) will be returned if the specified write data exceeds the data area boundaries, the beginning word is not specified in BCD, or the write data is not hexadecimal. (An end code of A5 will be returned instead of 15 for non-hexadecimal write data in multiple command frames.)

| End code (Hex) | Contents  |
|----------------|---|
| 00             | Normal completion                                       |
| 01             | Not executable in RUN mode                              |
| 13             | FCS error   |
| 14             | Format error  |
| 15             | Entry number data error                                 |
| 18             | Frame length error                                      |
| 21             | Not executable due to CPU Unit CPU error.               |
| A3             | Aborted due to FCS error in transmit data               |
| A4             | Aborted due to format error in transmit data            |
| A5             | Aborted due to entry number data error in transmit data |
| A8             | Aborted due to frame length error in transmit data      |



### 4-3-11 LR AREA WRITE -- WL

Writes data to the Link Area (CIO 1000 to CIO 1199) starting from the specified word. Writing is done in word units.

#### Command Format

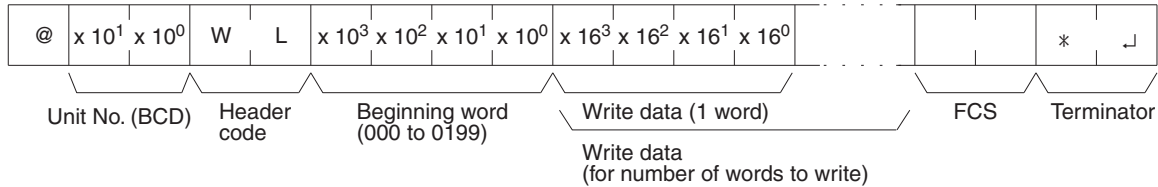

#### Response Format

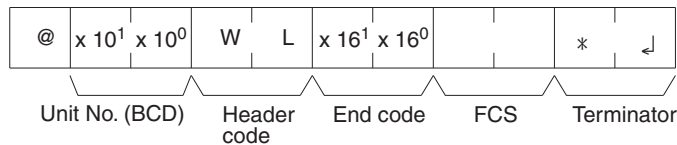

#### Execution Conditions

| Commands |          | Responses |          | PLC Mode |     |      | UM Area         |                |
|----------|----------|-----------|----------|----------|-----|------|-----------------|----------------|
| Single   | Multiple | Single    | Multiple | RUN      | MON | PROG | Write-protected | Read-protected |
| OK       | OK       | OK        | No       | No       | OK  | OK   | OK              | OK             |

#### End Codes

An end code of 14 (format error) will be returned if the length of the command is incorrect.

An end code of 15 (entry number data error) will be returned if the specified write data exceeds the data area boundary, the beginning word is not specified in BCD, or the write data is not hexadecimal. (An end code of A5 will be returned instead of 15 for non-hexadecimal write data in multiple command frames.)

| End code (Hex) | Contents  |
|----------------|---|
| 00             | Normal completion                                       |
| 01             | Not executable in RUN mode                              |
| 13             | FCS error   |
| 14             | Format error  |
| 15             | Entry number data error                                 |
| 18             | Frame length error                                      |
| 21             | Not executable due to CPU Unit CPU error.               |
| A3             | Aborted due to FCS error in transmit data               |
| A4             | Aborted due to format error in transmit data            |
| A5             | Aborted due to entry number data error in transmit data |
| A8             | Aborted due to frame length error in transmit data      |

**Note** The command is provided for compatibility with previous models. We recommend using CIO AREA WRITE (WR) whenever possible.

### 4-3-12 HR AREA WRITE -- WH

Writes data to the HR Area (H000 to H511) starting from the specified word. Writing is done in word units.

#### Command Format

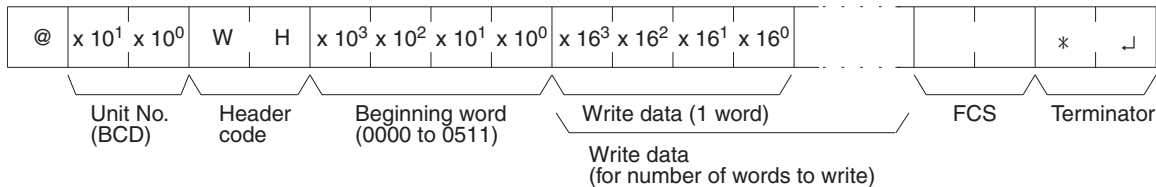

#### Response Format

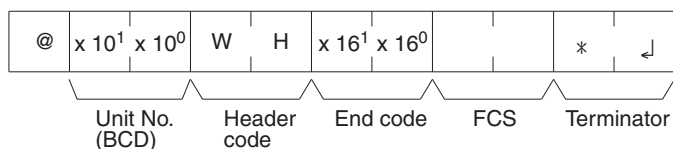

#### Execution Conditions

| Commands |          | Responses |          | PLC Mode |     |      | UM Area         |                |
|----------|----------|-----------|----------|----------|-----|------|-----------------|----------------|
| Single   | Multiple | Single    | Multiple | RUN      | MON | PROG | Write-protected | Read-protected |
| OK       | OK       | OK        | No       | No       | OK  | OK   | OK              | OK             |

#### End Codes

An end code of 14 (format error) will be returned if the length of the command is incorrect or the first word of write data is not in the first frame.

An end code of 15 (entry number data error) will be returned if the specified write data exceeds the data area boundary, the beginning word is not specified in BCD, or the write data is not hexadecimal. (An end code of A5 will be returned instead of 15 for non-hexadecimal write data in multiple command frames.)

| End code (Hex) | Contents  |
|----------------|---|
| 00             | Normal completion                                       |
| 01             | Not executable in RUN mode                              |
| 13             | FCS error   |
| 14             | Format error  |
| 15             | Entry number data error                                 |
| 18             | Frame length error                                      |
| 21             | Not executable due to CPU Unit CPU error.               |
| A3             | Aborted due to FCS error in transmit data               |
| A4             | Aborted due to format error in transmit data            |
| A5             | Aborted due to entry number data error in transmit data |
| A8             | Aborted due to frame length error in transmit data      |

### 4-3-13 TIMER/COUNTER PV WRITE -- WC

Writes the PVs (present values T0000 to T2047 or C0000 to C2047) of timers/counters starting from the specified word.

#### Command Format

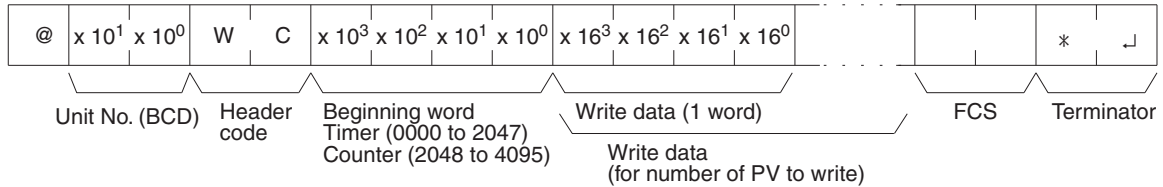

#### Response Format

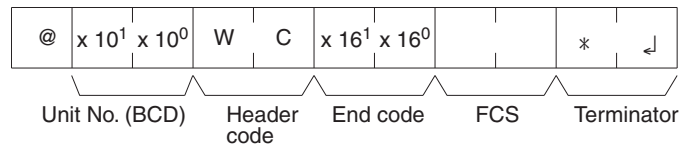

#### Limitations

Commands are divided with regard to timers and counters. If an attempt is made to designate across timers and counters, an end code of 15 (entry number data error) will be returned.

#### Execution Conditions

| Commands |          | Responses |          | PLC Mode |     |      | UM Area         |                |
|----------|----------|-----------|----------|----------|-----|------|-----------------|----------------|
| Single   | Multiple | Single    | Multiple | RUN      | MON | PROG | Write-protected | Read-protected |
| OK       | OK       | OK        | No       | No       | OK  | OK   | OK              | OK             |

#### End Codes

An end code of 14 (format error) will be returned if the length of the command is incorrect.

An end code of 15 (entry number data error) will be returned if the specified write data exceeds the data area boundary, the beginning word is not specified in BCD, or the write data is not hexadecimal. (An end code of A5 will be returned instead of 15 for non-hexadecimal write data in multiple command frames.)

| End code (Hex) | Contents  |
|----------------|---|
| 00             | Normal completion                                       |
| 01             | Not executable in RUN mode                              |
| 13             | FCS error   |
| 14             | Format error  |
| 15             | Entry number data error                                 |
| 18             | Frame length error                                      |
| 21             | Not executable due to CPU Unit CPU error.               |
| A3             | Aborted due to FCS error in transmit data               |
| A4             | Aborted due to format error in transmit data            |
| A5             | Aborted due to entry number data error in transmit data |
| A8             | Aborted due to frame length error in transmit data      |

### 4-3-14 DM AREA WRITE -- WD

Writes data to the DM Area starting from the specified word (D00000 to D09999). Writing is done in word units.

#### Command Format

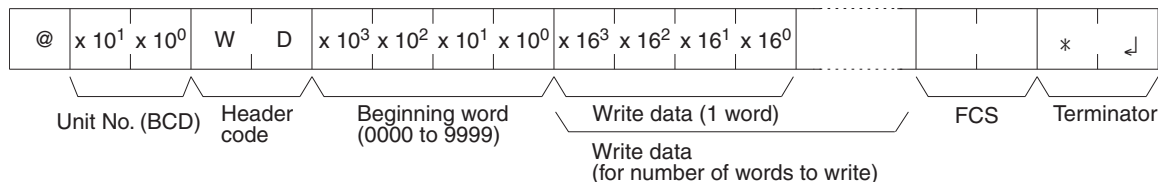

#### Response Format

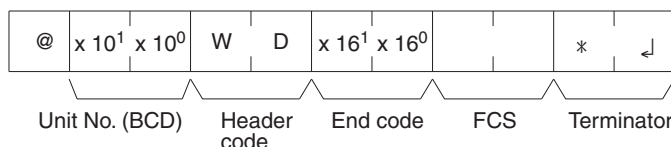

#### Limitations

The DM Area is comprised of D00000 to D32767, but the range that can be read by this command is D00000 to D09999.

#### Execution Conditions

| Commands |          | Responses |          | PLC Mode |     |      | UM Area         |                |
|----------|----------|-----------|----------|----------|-----|------|-----------------|----------------|
| Single   | Multiple | Single    | Multiple | RUN      | MON | PROG | Write-protected | Read-protected |
| OK       | OK       | OK        | No       | No       | OK  | OK   | OK              | OK             |

#### End Codes

An end code of 14 (format error) will be returned if the length of the command is incorrect or the first word of write data is not in the first frame.

An end code of 15 (entry number data error) will be returned if the specified write data exceeds the data area boundary, the beginning word is not specified in BCD, or the write data is not hexadecimal. (An end code of A5 will be returned instead of 15 for non-hexadecimal write data in multiple command frames.)

| End code (Hex) | Contents  |
|----------------|---|
| 00             | Normal completion                                       |
| 01             | Not executable in RUN mode                              |
| 13             | FCS error   |
| 14             | Format error  |
| 15             | Entry number data error                                 |
| 18             | Frame length error                                      |
| 21             | Not executable due to CPU Unit CPU error.               |
| A3             | Aborted due to FCS error in transmit data               |
| A4             | Aborted due to format error in transmit data            |
| A5             | Aborted due to entry number data error in transmit data |
| A8             | Aborted due to frame length error in transmit data      |

## 4-3-15 AR AREA WRITE -- WJ

Writes data to the Auxiliary Area (A448 to A959) starting from the specified word. Writing is done in word units.

## Command Format

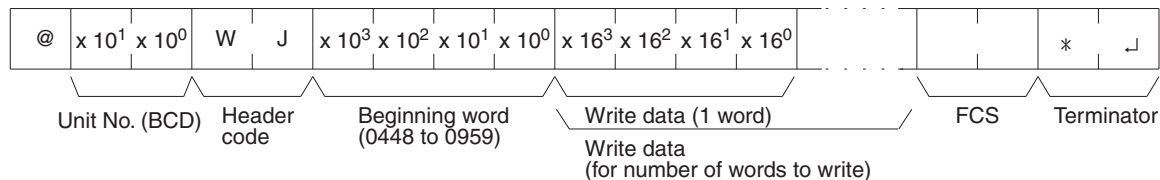

## Response Format

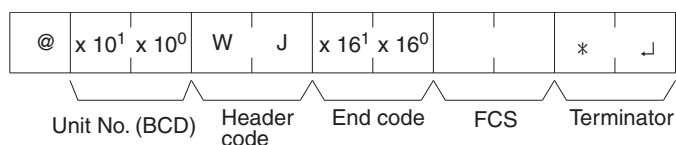

## Execution Conditions

| Commands |          | Responses |          | PLC Mode |     |      | UM Area         |                |
|----------|----------|-----------|----------|----------|-----|------|-----------------|----------------|
| Single   | Multiple | Single    | Multiple | RUN      | MON | PROG | Write-protected | Read-protected |
| OK       | OK       | OK        | No       | No       | OK  | OK   | OK              | OK             |

## End Codes

An end code of 14 (format error) will be returned if the length of the command is incorrect or the first word of write data is not in the first frame.

An end code of 15 (entry number data error) will be returned if the specified write data exceeds the data area boundary, the beginning word is not specified in BCD, or the write data is not hexadecimal. (An end code of A5 will be returned instead of 15 for non-hexadecimal write data in multiple command frames.)

| End code (Hex) | Contents  |
|----------------|---|
| 00             | Normal completion                                       |
| 01             | Not executable in RUN mode                              |
| 13             | FCS error   |
| 14             | Format error  |
| 15             | Entry number data error                                 |
| 18             | Frame length error                                      |
| 21             | Not executable due to CPU Unit CPU error.               |
| A3             | Aborted due to FCS error in transmit data               |
| A4             | Aborted due to format error in transmit data            |
| A5             | Aborted due to entry number data error in transmit data |
| A8             | Aborted due to frame length error in transmit data      |

### 4-3-16 EM AREA WRITE -- WE

Writes data to the specified EM Area bank starting from the specified word (E00000 to E09999). Writing is done in word units.

#### Command Format

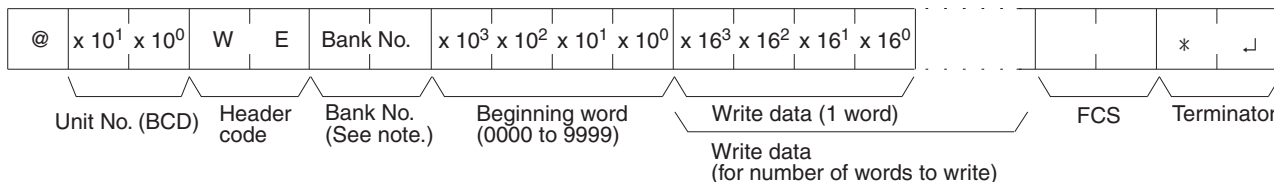

**Note** Input 00 to 0C to specify bank number 0 to C. Input two spaces to specify the current bank.

#### Response Format

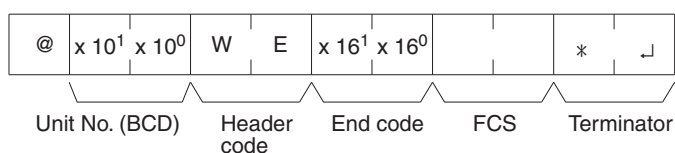

#### Limitations

The range that can be designated is E0000 to E9999. A single bank of EM consists of E00000 to E32767, but the range that can be written by this command is E00000 to E09999. The maximum EM bank number that can be specified is 12 (0C Hex).

#### Execution Conditions

| Commands |          | Responses |          | PLC Mode |     |      | UM Area         |                |
|----------|----------|-----------|----------|----------|-----|------|-----------------|----------------|
| Single   | Multiple | Single    | Multiple | RUN      | MON | PROG | Write-protected | Read-protected |
| OK       | OK       | OK        | No       | No       | OK  | OK   | OK              | OK             |

#### End Codes

An end code of 14 (format error) will be returned if the length of the command is incorrect or the first word of write data is not in the first frame.

An end code of 15 (entry number data error) will be returned if the specified write data exceeds the data area boundary, the beginning word is not specified in BCD, or the write data is not hexadecimal. An end code of 15 will also be returned if there are no banks and file memory access is not possible. (An end code of A5 will be returned instead of 15 for non-hexadecimal write data in multiple command frames.)

| End code (Hex) | Contents  |
|----------------|---|
| 00             | Normal completion                                       |
| 01             | Not executable in RUN mode                              |
| 13             | FCS error   |
| 14             | Format error  |
| 15             | Entry number data error                                 |
| 18             | Frame length error                                      |
| 21             | Not executable due to CPU Unit CPU error.               |
| A3             | Aborted due to FCS error in transmit data               |
| A4             | Aborted due to format error in transmit data            |
| A5             | Aborted due to entry number data error in transmit data |
| A8             | Aborted due to frame length error in transmit data      |

### 4-3-17 TIMER/COUNTER SV READ 1 -- R#

Reads the constant SV (4 digits BCD) written in the operands of designated timer/counter instructions from cyclic task 0. If there are multiple timer/counter instructions designated in cyclic task 0, TIMER/COUNTER SV READ 1 will read the SV of the designated instruction with the lowest program address.

**Command Format**

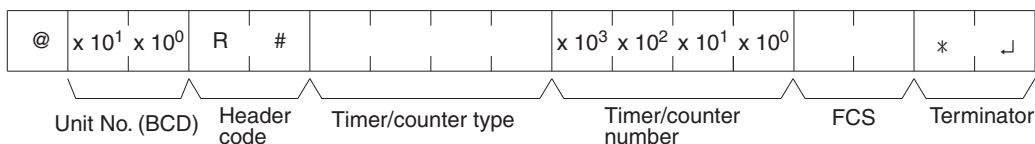

| Instruction name        | Timer/counter type |             |             |             | Timer/counter number (BCD) |
|-------------------------|--------------------|-------------|-------------|-------------|----------------------------|
|                         | Character 1        | Character 2 | Character 3 | Character 4 |                            |
| HIGH-SPEED COUNTER WAIT | T                  | M           | H           | W           | 0000 to 2047               |
| TIMER WAIT              | T                  | I           | M           | W           |                            |
| COUNTER WAIT            | C                  | N           | T           | W           |                            |
| HIGH-SPEED TIMER        | T                  | I           | M           | H           |                            |
| TOTALIZING TIMER        | T                  | T           | I           | M           |                            |
| REVERSIBLE COUNTER      | C                  | N           | T           | R           |                            |
| TIMER                   | T                  | I           | M           | (SP)        |                            |
| COUNTER                 | C                  | N           | T           | (SP)        |                            |

**Note** "SP" represents a space (20 Hex).

**Response Format**

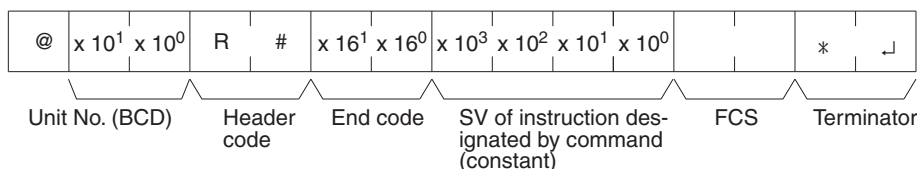

**Parameters**

**Timer/Counter Type (Command)**

Designate in ASCII characters the type of TC instruction for reading the constant SV.

**Timer Counter Number (Command)**

Designate in four digits (BCD) the timer/counter number for reading the constant SV.

**Limitations**

Timers T2048 to T4095 and counters C2048 to C4095 cannot be read.

The second word of the instruction must be a constant.

This command cannot be executed while UM read protection is in effect.

If there are multiple relevant instructions in the UM Area, a search will be conducted from program address 0, and the first instruction found will be read.

SV can be read only from cyclic task 0.

**Execution Conditions**

| Commands |          | Responses |          | PLC Mode |     |      | UM Area         |                |
|----------|----------|-----------|----------|----------|-----|------|-----------------|----------------|
| Single   | Multiple | Single    | Multiple | RUN      | MON | PROG | Write-protected | Read-protected |
| OK       | No       | OK        | No       | OK       | OK  | OK   | OK              | No             |

**End Codes**

An end code of 14 (format error) will be returned if the length of the command is incorrect.

An end code of 15 (entry number data error) will be returned if the timer/counter type or timer/counter number is out of range (including hexadecimal data).

An end code of 16 (command not supported) will be returned if the specified instruction does not exist in the UM Area.

| End code (Hex) | Contents                                  |
|----------------|---|
| 00             | Normal completion                         |
| 13             | FCS error                                 |
| 14             | Format error                              |
| 15             | Entry number data error                   |
| 16             | Command not supported                     |
| 18             | Frame length error                        |
| 21             | Not executable due to CPU Unit CPU error. |
| 23             | User memory protected                     |

**4-3-18 TIMER/COUNTER SV READ 2 -- R\$**

From the specified program address onwards in cyclic task 0, TIMER/COUNTER SV READ 2 finds the specified timer/counter instruction and reads the 4-digit constant SV that is set or the word address where the SV is stored.

**Command Format**

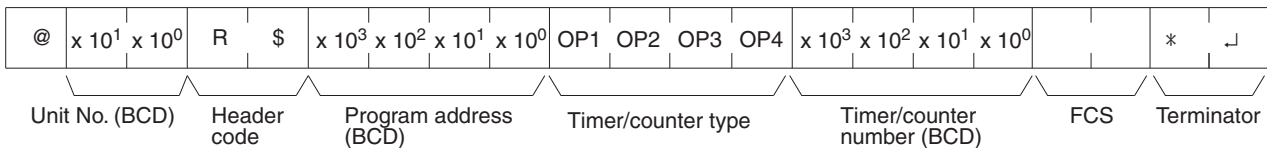

| Instruction name        | Timer/counter type |              |              |              | Timer/counter number (BCD) |
|-------------------------|--------------------|--------------|--------------|--------------|----------------------------|
|                         | Char-acter 1       | Char-acter 2 | Char-acter 3 | Char-acter 4 |                            |
| HIGH-SPEED COUNTER WAIT | T                  | M            | H            | W            | 0000 to 2047               |
| TIMER WAIT              | T                  | I            | M            | W            |                            |
| COUNTER WAIT            | C                  | N            | T            | W            |                            |
| HIGH-SPEED TIMER        | T                  | I            | M            | H            |                            |
| TOTALIZING TIMER        | T                  | T            | I            | M            |                            |
| REVERSIBLE COUNTER      | C                  | N            | T            | R            |                            |
| TIMER                   | T                  | I            | M            | (SP)         |                            |
| COUNTER                 | C                  | N            | T            | (SP)         |                            |

**Note** "SP" represents a space (20 Hex).



## Response Format

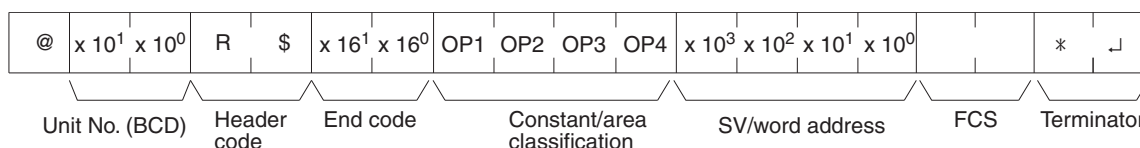

| Classification             | Constant/area classification |             |             |             | SV or word address |
|----------------------------|------------------------------|-------------|-------------|-------------|--------------------|
|                            | Character 1                  | Character 2 | Character 3 | Character 4 |                    |
| Constant                   | C                            | O           | N           | (SP)        | 0000 to 9999       |
| CIO                        | C                            | I           | O           | (SP)        | 0000 to 6143       |
| AR                         | A                            | R           | (SP)        | (SP)        | 0000 to 0959       |
| HR                         | H                            | R           | (SP)        | (SP)        | 0000 to 0511       |
| WR                         | W                            | R           | (SP)        | (SP)        | 0000 to 0511       |
| Timer                      | T                            | I           | M           | (SP)        | 0000 to 2047       |
| Counter                    | C                            | N           | T           | (SP)        | 0000 to 2047       |
| DM                         | D                            | M           | (SP)        | (SP)        | 0000 to 9999       |
| DM (indirect)              | D                            | M           | *           | (SP)        | 0000 to 9999       |
| EM current bank            | E                            | M           | (SP)        | (SP)        | 0000 to 9999       |
| EM (indirect) current bank | E                            | M           | *           | (SP)        | 0000 to 9999       |
| EM banks 0 to C            | E                            | M           | 0 to C      | (SP)        | 0000 to 9999       |
| EM (indirect) banks 0 to C | E                            | M           | 0 to C      | *           | 0000 to 9999       |
| Data register              | D                            | R           | (SP)        | (SP)        | 0000 to 0015       |
| Index register (indirect)  | ,                            | I           | R           | (SP)        | 0000 to 0015       |

**Note** "SP" represents a space (20 Hex).

## Parameters

**Program Address (Command)**

Designates the program address in four digits decimal (BCD) for beginning the search for the specified timer/counter.

**Timer/Counter Type (Command)**

Designate in ASCII characters the timer/counter instruction type for reading the constant SV or the word address in which it is stored.

**Timer/Counter Number (Command)**

Designate in four digits (BCD) the timer/counter instruction number for reading the constant SV or the word address in which it is stored. (Data register designation is not possible.)

**Constant/Area Classification (Response)**

The constant or I/O memory area classification is returned, in ASCII, to this parameter.

**SV/Word Address (Response)**

The constant SV or the word address in which it is stored is returned to this parameter.

## Limitations

Timers T2048 to T4095 and counters C2048 to C4095 cannot be read.

The SV of the first timer/counter found after the designated program address will be read.

If the SV is outside of range for the timer/counter type or number, an end code of 16 (command not supported) will be returned.

If the SV is a DM or EM indirect address, only indirect BCD designations will be read and an end code of 16 (command not supported) will be returned if the indirect designation is not BCD.

SV can be read only from cyclic task 0.

#### Execution Conditions

| Commands |          | Responses |          | PLC Mode |     |      | UM Area         |                |
|----------|----------|-----------|----------|----------|-----|------|-----------------|----------------|
| Single   | Multiple | Single    | Multiple | RUN      | MON | PROG | Write-protected | Read-protected |
| OK       | No       | OK        | No       | OK       | OK  | OK   | OK              | No             |

#### End Codes

An end code of 14 (format error) will be returned if the length of the command is incorrect.

An end code of 15 (entry number data error) will be returned if the program address is not specified in BCD or the operand/SV parameters are incorrect.

An end code of 16 (command not supported) will be returned if the specified instruction does not exist in the UM Area.

| End code (Hex) | Contents                                  |
|----------------|---|
| 00             | Normal completion                         |
| 04             | Address over                              |
| 13             | FCS error                                 |
| 14             | Format error                              |
| 15             | Entry number data error                   |
| 16             | Command not supported                     |
| 18             | Frame length error                        |
| 21             | Not executable due to CPU Unit CPU error. |
| 23             | User memory protected                     |

#### 4-3-19 TIMER/COUNTER SV READ 3 -- R%

From the specified program address onwards in cyclic task 0, TIMER/COUNTER SV READ 3 finds the specified TC instruction and reads the constant SV that is set or the word address where the SV is stored. The SV that is read is a 4-digit decimal number (BCD).

Command Format

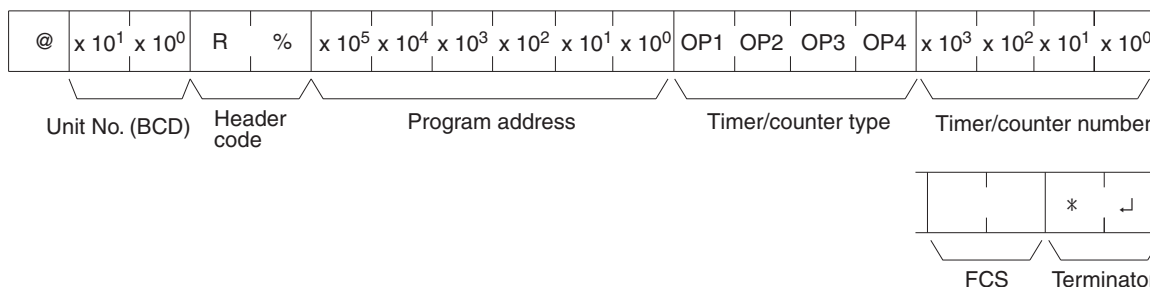

| Instruction name      | Timer/counter type |             |             |             | Timer/counter number |
|-----------------------|--------------------|-------------|-------------|-------------|----------------------|
|                       | Character 1        | Character 2 | Character 3 | Character 4 |                      |
| HIGH-SPEED TIMER WAIT | T                  | M           | H           | W           | 0000 to 2047         |
| TIMER WAIT            | T                  | I           | M           | W           |                      |
| COUNTER WAIT          | C                  | N           | T           | W           |                      |
| HIGH-SPEED TIMER      | T                  | I           | M           | H           |                      |
| TOTALIZING TIMER      | T                  | T           | I           | M           |                      |
| REVERSIBLE COUNTER    | C                  | N           | T           | R           |                      |
| TIMER                 | T                  | I           | M           | (SP)        |                      |
| COUNTER               | C                  | N           | T           | (SP)        |                      |

Note "SP" represents a space (20 Hex).

Response Format

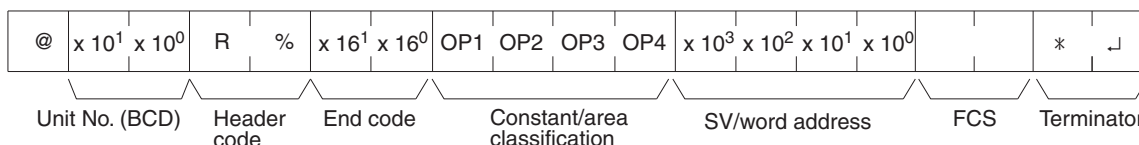

| Classification             | Constant/area classification |             |             |             | Constant or word address |
|----------------------------|------------------------------|-------------|-------------|-------------|--------------------------|
|                            | Character 1                  | Character 2 | Character 3 | Character 4 |                          |
| Constant                   | C                            | O           | N           | (SP)        | 0000 to 9999             |
| CIO                        | C                            | I           | O           | (SP)        | 0000 to 6143             |
| AR                         | A                            | R           | (SP)        | (SP)        | 0000 to 0959             |
| HR                         | H                            | R           | (SP)        | (SP)        | 0000 to 0511             |
| WR                         | W                            | R           | (SP)        | (SP)        | 0000 to 0511             |
| Timer                      | T                            | I           | M           | (SP)        | 0000 to 2047             |
| Counter                    | C                            | N           | T           | (SP)        | 0000 to 2047             |
| DM                         | D                            | M           | (SP)        | (SP)        | 0000 to 9999             |
| DM (indirect)              | D                            | M           | *           | (SP)        | 0000 to 9999             |
| EM current bank            | E                            | M           | (SP)        | (SP)        | 0000 to 9999             |
| EM (indirect) current bank | E                            | M           | *           | (SP)        | 0000 to 9999             |
| EM banks 0 to C            | E                            | M           | 0 to C      | (SP)        | 0000 to 9999             |
| EM (indirect) banks 0 to C | E                            | M           | 0 to C      | *           | 0000 to 9999             |
| Data register              | D                            | R           | (SP)        | (SP)        | 0000 to 0015             |
| Index register (indirect)  | ,                            | I           | R           | (SP)        | 0000 to 0015             |

**Note** "SP" represents a space (20 Hex).

**Parameters**

**Program Address (Command)**

Designates the program address in six digits decimal (BCD) for beginning the search for the specified timer/counter.

**Timer/Counter Type (Command)**

Designate the timer/counter instruction type for reading the constant SV or the word address in which it is stored.

**Timer/Counter Number (Command)**

Designate the timer/counter instruction number for reading the constant SV or the word address in which it is stored. (Index register designation is not possible.)

**Constant/Area Classification (Response)**

The constant or I/O memory area classification is returned, in ASCII, to this parameter.

**SV/Word Address (Response)**

The constant SV or the word address in which it is stored is returned to this parameter.

**Limitations**

Timers T2048 to T4095 and counters C2048 to C4095 cannot be read.

The SV of the first timer/counter found after the designated program address will be read.

If the SV is outside of range for the timer/counter type or number, an end code of 16 (command not supported) will be returned.

If the SV is a DM or EM indirect address, only indirect BCD designations will be read and an end code of 16 (command not supported) will be returned if the indirect designation is not BCD.

SV can be read only from cyclic task 0.

**Execution Conditions**

| Commands |          | Responses |          | PLC Mode |     |      | UM Area         |                |
|----------|----------|-----------|----------|----------|-----|------|-----------------|----------------|
| Single   | Multiple | Single    | Multiple | RUN      | MON | PROG | Write-protected | Read-protected |
| OK       | No       | OK        | No       | OK       | OK  | OK   | OK              | No             |

**End Codes**

An end code of 14 (format error) will be returned if the length of the command is incorrect.

An end code of 15 (entry number data error) will be returned if the program address is not specified in BCD, or if the timer/counter type or number is out of range (including hexadecimal data).

An end code of 16 (command not supported) will be returned if the specified instruction does not exist in the program.

| End code (Hex) | Contents                                  |
|----------------|---|
| 00             | Normal completion                         |
| 04             | Address over                              |
| 13             | FCS error                                 |
| 14             | Format error                              |
| 15             | Entry number data error                   |
| 16             | Command not supported                     |
| 18             | Frame length error                        |
| 21             | Not executable due to CPU Unit CPU error. |
| 23             | User memory protected                     |

### 4-3-20 TIMER/COUNTER SV CHANGE 1 -- W#

Changes the SV of the designated timer/counter instruction to a new constant SV.

#### Command Format

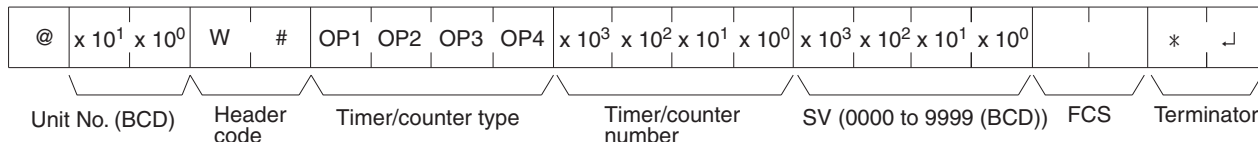

| Instruction name      | Timer/counter type |              |              |              | Timer/counter number (BCD) |
|-----------------------|--------------------|--------------|--------------|--------------|----------------------------|
|                       | Char-acter 1       | Char-acter 2 | Char-acter 3 | Char-acter 4 |                            |
| HIGH-SPEED TIMER WAIT | T                  | M            | H            | W            | 0000 to 2047               |
| TIMER WAIT            | T                  | I            | M            | W            |                            |
| COUNTER WAIT          | C                  | N            | T            | W            |                            |
| HIGH-SPEED TIMER      | T                  | I            | M            | H            |                            |
| TOTALIZING TIMER      | T                  | T            | I            | M            |                            |
| REVERSIBLE COUNTER    | C                  | N            | T            | R            |                            |
| TIMER                 | T                  | I            | M            | (SP)         |                            |
| COUNTER               | C                  | N            | T            | (SP)         |                            |

**Note** "SP" represents a space (20 Hex).

#### Response Format

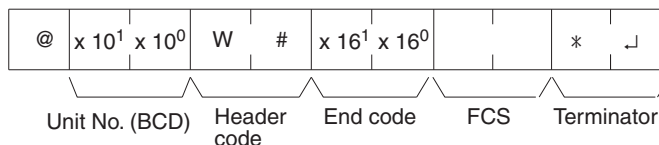

#### Parameters

##### Timer/Counter Type (Command)

Designate the timer/counter instruction type for changing the constant SV.

##### Timer/Counter Number (Command)

Designate in four digits BCD the timer/counter instruction number for changing the constant SV. (Index register designation is not possible.)

##### New Constant SV (Command)

Designate the new constant SV in four digits hexadecimal.

#### Limitations

Timers T2048 to T4095 and counters C2048 to C4095 cannot be read.

The command cannot be executed unless the SV is a constant.

If there are multiple relevant instructions in cyclic task 0, a search will be conducted from program address 0, and the first instruction found will be read.

The SV can be changed only in cyclic task 0.

If the SV is a DM or EM indirect address, only indirect BCD designations will be read and an end code of 16 (command not supported) will be returned if the indirect designation is not BCD.

#### Execution Conditions

| Commands |          | Responses |          | PLC Mode |     |      | UM Area         |                |
|----------|----------|-----------|----------|----------|-----|------|-----------------|----------------|
| Single   | Multiple | Single    | Multiple | RUN      | MON | PROG | Write-protected | Read-protected |
| OK       | No       | OK        | No       | No       | OK  | OK   | No              | No             |

**End Codes**

An end code of 14 (format error) will be returned if the length of the command is incorrect.

An end code of 15 (entry number data error) will be returned if the program address is not specified in BCD, or if the timer/counter type or number is out of range (including hexadecimal data).

An end code of 16 (command not supported) will be returned if the specified instruction does not exist in the UM Area.

| End code (Hex) | Contents                                  |
|----------------|---|
| 00             | Normal completion                         |
| 01             | Not executable in RUN mode                |
| 04             | Address over                              |
| 13             | FCS error                                 |
| 14             | Format error                              |
| 15             | Entry number data error                   |
| 16             | Command not supported                     |
| 18             | Frame length error                        |
| 19             | Not executable                            |
| 21             | Not executable due to CPU Unit CPU error. |
| 23             | User memory protected                     |

**4-3-21 TIMER/COUNTER SV CHANGE 2 -- W\$**

From the specified program address onwards in cyclic task 0, TIMER/COUNTER SV CHANGE 2 finds the specified timer/counter instruction and changes the 4-digit constant SV (BCD) that is set, or the word address where the SV is stored, to a newly designated constant SV or storage word address.

**Command Format**

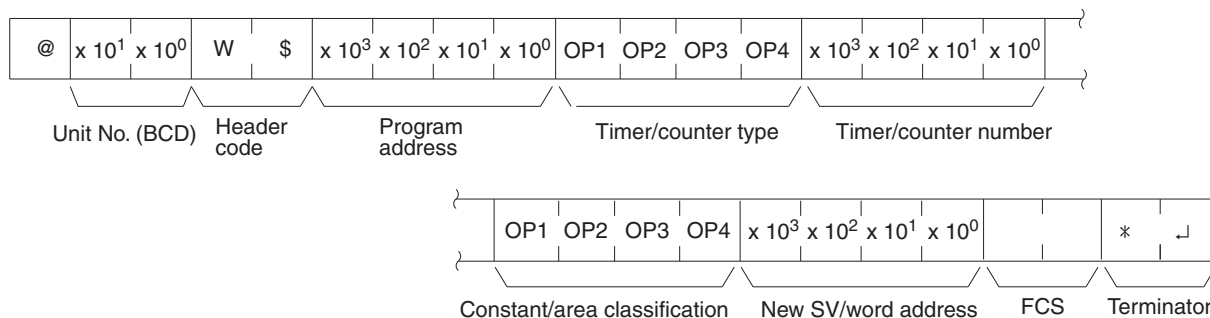

| Instruction name      | Timer/counter type |              |              |              | Timer/counter number |
|-----------------------|--------------------|--------------|--------------|--------------|----------------------|
|                       | Char-acter 1       | Char-acter 2 | Char-acter 3 | Char-acter 4 |                      |
| HIGH-SPEED TIMER WAIT | T                  | M            | H            | W            | 0000 to 2047         |
| TIMER WAIT            | T                  | I            | M            | W            |                      |
| COUNTER WAIT          | C                  | N            | T            | W            |                      |
| HIGH-SPEED TIMER      | T                  | I            | M            | H            |                      |
| TOTALIZING TIMER      | T                  | T            | I            | M            |                      |
| REVERSIBLE COUNTER    | C                  | N            | T            | R            |                      |
| TIMER                 | T                  | I            | M            | (SP)         |                      |
| COUNTER               | C                  | N            | T            | (SP)         |                      |

**Note** “SP” represents a space (20 Hex).

| Classification             | Constant/area classification |             |             |             | SV or word address (BCD) |
|----------------------------|------------------------------|-------------|-------------|-------------|--------------------------|
|                            | Character 1                  | Character 2 | Character 3 | Character 4 |                          |
| Constant                   | C                            | O           | N           | (SP)        | 0000 to 9999             |
| CIO                        | C                            | I           | O           | (SP)        | 0000 to 6143             |
| AR                         | A                            | R           | (SP)        | (SP)        | 0000 to 0959             |
| HR                         | H                            | R           | (SP)        | (SP)        | 0000 to 0511             |
| WR                         | W                            | R           | (SP)        | (SP)        | 0000 to 0511             |
| Timer                      | T                            | I           | M           | (SP)        | 0000 to 2047             |
| Counter                    | C                            | N           | T           | (SP)        | 0000 to 2047             |
| DM                         | D                            | M           | (SP)        | (SP)        | 0000 to 9999             |
| DM (indirect)              | D                            | M           | *           | (SP)        | 0000 to 9999             |
| EM current bank            | E                            | M           | (SP)        | (SP)        | 0000 to 9999             |
| EM (indirect) current bank | E                            | M           | *           | (SP)        | 0000 to 9999             |
| EM banks 0 to C            | E                            | M           | 0 to C      | (SP)        | 0000 to 9999             |
| EM (indirect) 0 to C       | E                            | M           | 0 to C      | *           | 0000 to 9999             |
| Data register              | D                            | R           | (SP)        | (SP)        | 0000 to 0015             |
| Index register             | ,                            | I           | R           | (SP)        | 0000 to 0015             |

**Note** “SP” represents a space (20 Hex).

### Response Format

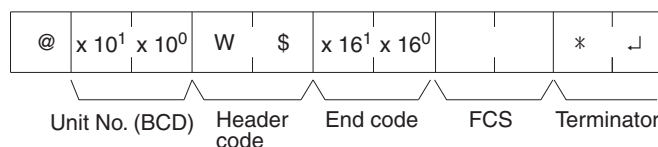

### Parameters

#### **Program Address (Command)**

Designate the program address in four digits decimal (BCD) for beginning the search for the specified timer/counter instruction.

#### **Timer/Counter Type (Command)**

Designate the timer/counter instruction type for changing the constant SV or the word address in which it is stored.

#### **Timer/Counter Number (Command)**

Designate the timer/counter instruction number for reading the constant SV. (Index register designation is not possible.) The range that can be designated is the same as for R#.

#### **Constant/Area Classification (Command)**

Designate the ASCII characters to express the new SV area classification or constant.

#### **New SV/Word Address (Command)**

Designate the newly set constant SV or the word address in which it is stored.

### Limitations

Timers T2048 to T4095 and counters C2048 to C4095 cannot be read.

The SV of the first timer/counter found after the designated program address will be read.

If the SV is outside of range for the timer/counter type or number, an end code of 16 (command not supported) will be returned.

If the SV is a DM or EM indirect address, only indirect BCD designations will be read and an end code of 16 (command not supported) will be returned if the indirect designation is not BCD.

The SV can be changed only in cyclic task 0.

The maximum EM bank number that can be specified is 12 (0C Hex).

**Execution Conditions**

| Commands |          | Responses |          | PLC Mode |     |      | UM Area         |                |
|----------|----------|-----------|----------|----------|-----|------|-----------------|----------------|
| Single   | Multiple | Single    | Multiple | RUN      | MON | PROG | Write-protected | Read-protected |
| OK       | No       | OK        | No       | No       | OK  | OK   | No              | No             |

**End Codes**

An end code of 14 (format error) will be returned if the length of the command is incorrect.

An end code of 15 (entry number data error) will be returned if the program address is not BCD, or if the timer/counter type or number is out of range (including hexadecimal data).

An end code of 16 (command not supported) will be returned if the specified instruction does not exist in the UM Area.

| End code (Hex) | Contents                                  |
|----------------|---|
| 00             | Normal completion                         |
| 01             | Not executable in RUN mode                |
| 04             | Address over                              |
| 13             | FCS error                                 |
| 14             | Format error                              |
| 15             | Entry number data error                   |
| 16             | Command not supported                     |
| 18             | Frame length error                        |
| 19             | Not executable                            |
| 21             | Not executable due to CPU Unit CPU error. |
| 23             | User memory protected                     |

**4-3-22 TIMER/COUNTER SV CHANGE 3 -- W%**

From the specified program address onwards in cyclic task 0, TIMER/COUNTER SV CHANGE 3 finds the specified timer/counter instruction and changes the 4-digit constant SV (BCD) that is set, or the word address where the SV is stored, to a newly designated constant SV or storage word address.



Command Format

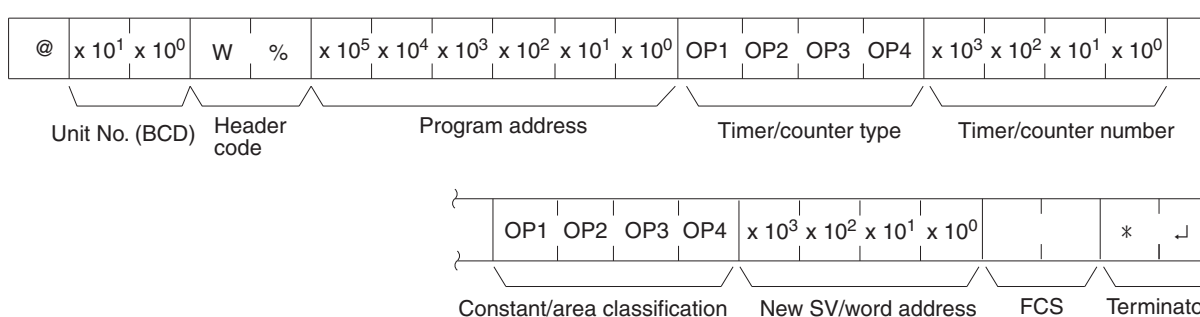

| Instruction name   | Timer/counter type |              |              |              | Timer/counter number |
|--------------------|--------------------|--------------|--------------|--------------|----------------------|
|                    | Char-acter 1       | Char-acter 2 | Char-acter 3 | Char-acter 4 |                      |
| HIGH-SPEED TIMER   | T                  | M            | H            | W            | 0000 to 2047         |
| WAIT               |                    |              |              |              |                      |
| TIMER WAIT         | T                  | I            | M            | W            |                      |
| COUNTER WAIT       | C                  | N            | T            | W            |                      |
| HIGH-SPEED TIMER   | T                  | I            | M            | H            |                      |
| TOTALIZING TIMER   | T                  | T            | I            | M            |                      |
| REVERSIBLE COUNTER | C                  | N            | T            | R            |                      |
| TIMER              | T                  | I            | M            | (SP)         |                      |
| COUNTER            | C                  | N            | T            | (SP)         |                      |

Note "SP" represents a space (20 Hex).

| Classification             | Constant/area classification |              |              |              | SV or word address (BCD) |
|----------------------------|------------------------------|--------------|--------------|--------------|--------------------------|
|                            | Char-acter 1                 | Char-acter 2 | Char-acter 3 | Char-acter 4 |                          |
| Constant                   | C                            | O            | N            | (SP)         | 0000 to 9999             |
| CIO                        | C                            | I            | O            | (SP)         | 0000 to 6143             |
| AR                         | A                            | R            | (SP)         | (SP)         | 0000 to 0959             |
| HR                         | H                            | R            | (SP)         | (SP)         | 0000 to 0511             |
| WR                         | W                            | R            | (SP)         | (SP)         | 0000 to 0511             |
| Timer                      | T                            | I            | M            | (SP)         | 0000 to 2047             |
| Counter                    | C                            | N            | T            | (SP)         | 0000 to 2047             |
| DM                         | D                            | M            | (SP)         | (SP)         | 0000 to 9999             |
| DM (indirect)              | D                            | M            | *            | (SP)         | 0000 to 9999             |
| EM current bank            | E                            | M            | (SP)         | (SP)         | 0000 to 9999             |
| EM (indirect) current bank | E                            | M            | *            | (SP)         | 0000 to 9999             |
| EM banks 0 to C            | E                            | M            | 0 to C       | (SP)         | 0000 to 9999             |
| EM (indirect) 0 to C       | E                            | M            | 0 to C       | *            | 0000 to 9999             |
| Data register              | D                            | R            | (SP)         | (SP)         | 0000 to 0015             |
| Index register             | ,                            | I            | R            | (SP)         | 0000 to 0015             |

Note "SP" represents a space (20 Hex).

Response Format

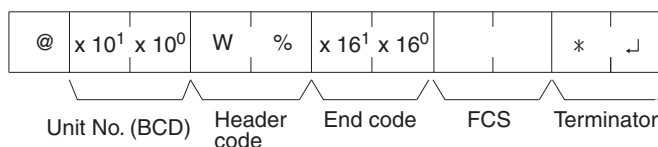

Parameters

**Program Address (Command)**

Designate the program address in six digits decimal (BCD) for beginning the search for the specified timer/counter instruction.

**Timer/Counter Type (Command)**

Designate the timer/counter instruction type, in ASCII, for changing the constant SV or the word address in which it is stored.

**Timer/Counter Number (Command)**

Designate in four digits BCD the timer/counter instruction number for reading the constant SV. (Index register designation is not possible.)

**Constant/Area Classification (Command)**

Designate the ASCII characters to express the constant or area classification.

**New SV/Word Address (Command)**

Designate the newly set constant SV or the word address in which it is stored.

Limitations

Timers T2048 to T4095 and counters C2048 to C4095 cannot be changed. If the SV is a DM or EM indirect address, only indirect BCD designations will be read and an end code of 16 (command not supported) will be returned if the indirect designation is not BCD. The SV can be changed only in cyclic task 0. The maximum EM bank number that can be specified is 12 (0C Hex).

Execution Conditions

| Commands |          | Responses |          | PLC Mode |     |      | UM Area         |                |
|----------|----------|-----------|----------|----------|-----|------|-----------------|----------------|
| Single   | Multiple | Single    | Multiple | RUN      | MON | PROG | Write-protected | Read-protected |
| OK       | No       | OK        | No       | No       | OK  | OK   | No              | No             |

End Codes

An end code of 14 (format error) will be returned if the length of the command is incorrect.  
 An end code of 15 (entry number data error) will be returned if the program address is not BCD, or if the timer/counter type or number is out of range (including hexadecimal data).  
 An end code of 15 (entry number data error) will be returned if a constant or area classification is out of range (including hexadecimal data).  
 An end code of 16 (command not supported) will be returned if the specified instruction does not exist in the UM Area.

| End code (Hex) | Contents                                  |
|----------------|---|
| 00             | Normal completion                         |
| 01             | Not executable in RUN mode                |
| 04             | Address over                              |
| 13             | FCS error                                 |
| 14             | Format error                              |
| 15             | Entry number data error                   |
| 16             | Command not supported                     |
| 18             | Frame length error                        |
| 19             | Not executable                            |
| 21             | Not executable due to CPU Unit CPU error. |
| 23             | User memory protected                     |

### 4-3-23 STATUS READ -- MS

Reads the operating conditions (status) of the CPU Unit.

#### Command Format

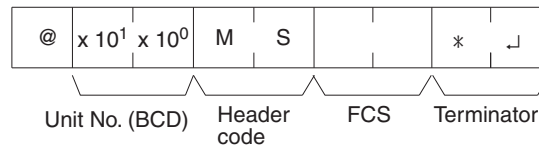

#### Response Format

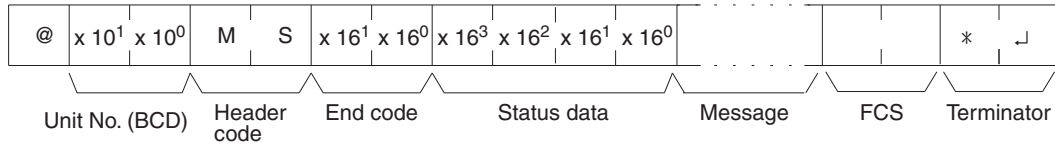

The message is attached only when there is a FAL/FALS message (always 16 characters)

“Status data” consists of four digits (two bytes) hexadecimal. The leftmost byte indicates the CPU Unit operation mode, and the rightmost byte indicates the size of the program area.

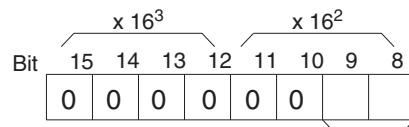

| Bit |   | Operation mode |
|-----|---|----------------|
| 9   | 8 |                |
| 0   | 0 | PROGRAM mode   |
| 1   | 0 | RUN mode       |
| 1   | 1 | MONITOR mode   |

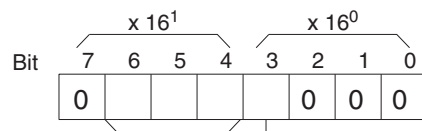

1: UM not write-protected  
0: UM write-protected

| Bit |   |   | Program area |
|-----|---|---|--------------|
| 6   | 5 | 4 |              |
| 0   | 0 | 1 | 10K steps    |
| 0   | 1 | 0 | 20K steps    |
| 0   | 1 | 1 | 30K steps    |
| 1   | 0 | 0 | 60K steps    |
| 1   | 0 | 1 | 120K steps   |
| 1   | 1 | 0 | 250K steps   |

(In the case of a CJ2 CPU Unit and CS1D-CPU68HA, this is fixed at 111)

#### Parameters

#### Message (Response)

The message for any FAL/FALS occurring during command execution will be returned.

**Limitations** RUN mode and MONITOR mode designations differ from those in STATUS WRITE.

**Execution Conditions**

| Commands |          | Responses |          | PLC Mode |     |      | UM Area         |                |
|----------|----------|-----------|----------|----------|-----|------|-----------------|----------------|
| Single   | Multiple | Single    | Multiple | RUN      | MON | PROG | Write-protected | Read-protected |
| OK       | No       | OK        | No       | OK       | OK  | OK   | OK              | OK             |

**End Codes** An end code of 14 (format error) will be returned if the length of the command is incorrect.

| End code (Hex) | Contents                                  |
|----------------|---|
| 00             | Normal completion                         |
| 13             | FCS error                                 |
| 14             | Format error                              |
| 18             | Frame length error                        |
| 21             | Not executable due to CPU Unit CPU error. |

**4-3-24 STATUS CHANGE -- SC**

Changes the CPU Unit operating mode.

**Command Format**

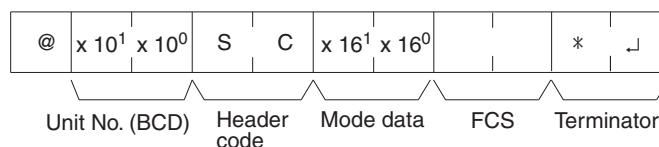

“Mode data” consists of two digits (one byte) hexadecimal. With the leftmost two bits, specify the CPU Unit operating mode. Set all of the remaining bits to “0.”

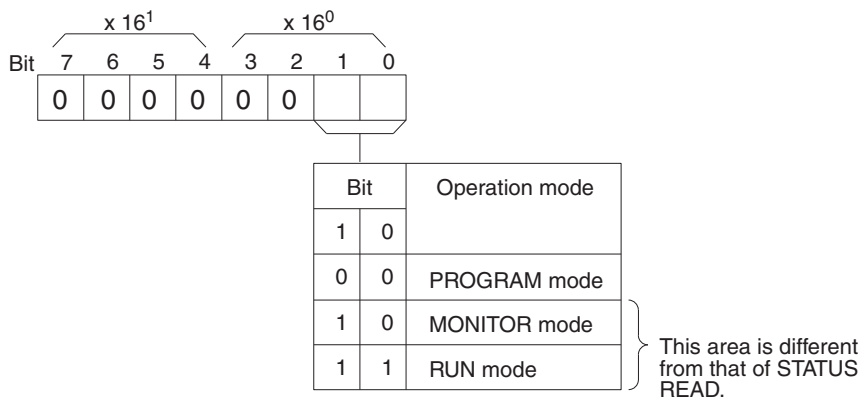

**Response Format**

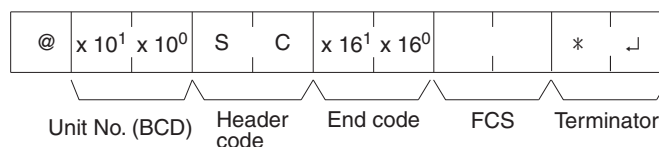

**Limitations** RUN mode and MONITOR mode designations differ from those in STATUS READ.

Execution Conditions

| Commands |          | Responses |          | PLC Mode |     |      | UM Area         |                |
|----------|----------|-----------|----------|----------|-----|------|-----------------|----------------|
| Single   | Multiple | Single    | Multiple | RUN      | MON | PROG | Write-protected | Read-protected |
| OK       | No       | OK        | No       | OK       | OK  | OK   | OK              | OK             |

End Codes

An end code of 14 (format error) will be returned if the length of the command is incorrect.

An end code of 15 (entry number data error) will be returned if the mode data is out of range.

| End code (Hex) | Contents                                  |
|----------------|---|
| 00             | Normal completion                         |
| 13             | FCS error                                 |
| 14             | Format error                              |
| 15             | Entry number data error                   |
| 18             | Frame length error                        |
| 19             | Not executable                            |
| 21             | Not executable due to CPU Unit CPU error. |

4-3-25 ERROR READ -- MF

Reads CPU Unit error information.

Command Format

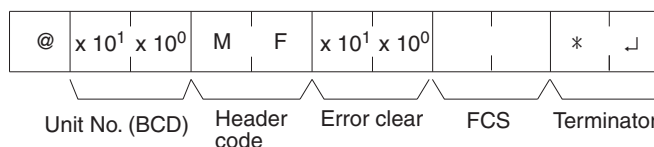

For the "error clear" parameter, specify 01 to clear errors and 00 to not clear errors (BCD).

Response Format

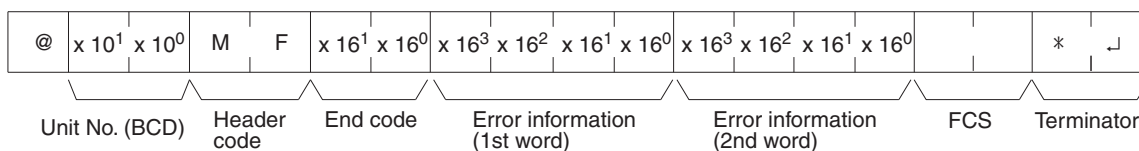

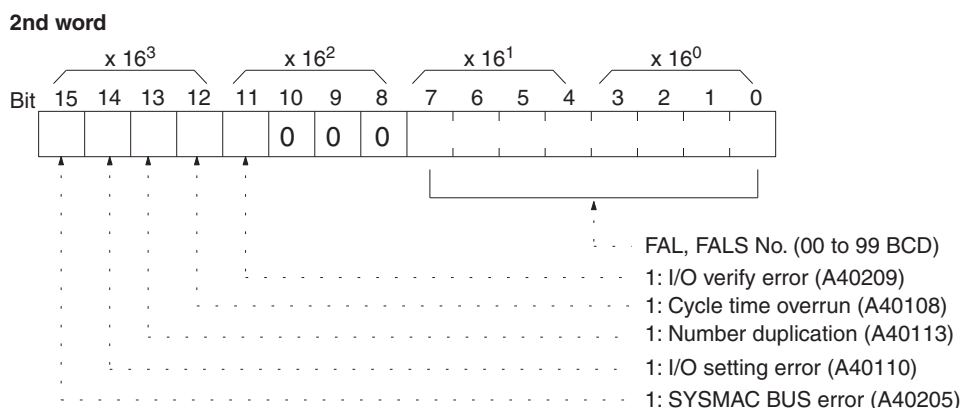
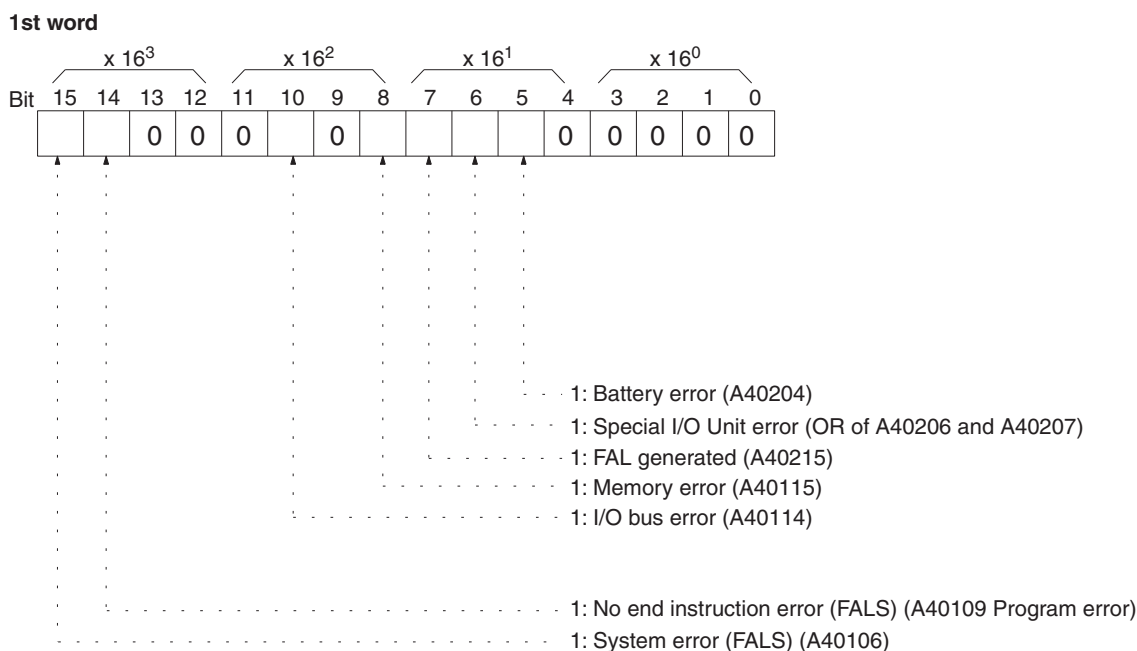

**Limitations** Only FAL and FALS numbers 0 to 99 can be read. For numbers 100 to 511, FAL/FALS number 00 will be set.

**Execution Conditions**

| Commands |          | Responses |          | PLC Mode |     |      | UM Area         |                |
|----------|----------|-----------|----------|----------|-----|------|-----------------|----------------|
| Single   | Multiple | Single    | Multiple | RUN      | MON | PROG | Write-protected | Read-protected |
| OK       | No       | OK        | No       | OK       | OK  | OK   | OK              | OK             |

**End Codes** An end code of 14 (format error) will be returned if the length of the command is incorrect.

An end code of 15 (entry number data error) will be returned if the error clear parameter is not set to 00 or 01.

| End code (Hex) | Contents                       |
|----------------|--------------------------------|
| 00             | Normal completion              |
| 01             | Not executable in RUN mode     |
| 02             | Not executable in MONITOR mode |
| 13             | FCS error                      |
| 14             | Format error                   |
| 15             | Entry number data error        |
| 18             | Frame length error             |

| End code (Hex) | Contents                                  |
|----------------|---|
| 19             | Not executable                            |
| 21             | Not executable due to CPU Unit CPU error. |

### 4-3-26 FORCED SET -- KS

Force sets the operating status of operands. (Only one bit at a time can be force set.)

#### Command Format

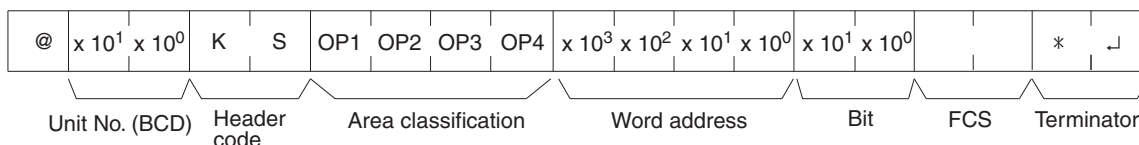

| Classification | Area classification |             |             |             | Word address | Bit       |
|----------------|---------------------|-------------|-------------|-------------|--------------|-----------|
|                | Character 1         | Character 2 | Character 3 | Character 4 |              |           |
| CIO            | C                   | I           | O           | (SP)        | 0000 to 6143 | 00 to 15  |
| LR             | L                   | R           | (SP)        | (SP)        | 0000 to 0199 | 00 to 15  |
| WR             | W                   | R           | (SP)        | (SP)        | 0000 to 0511 | 00 to 15  |
| HR             | H                   | R           | (SP)        | (SP)        | 0000 to 0511 | 00 to 15  |
| Timer          | T                   | I           | M           | (SP)        | 0000 to 2047 | Always 00 |
| Counter        | C                   | N           | T           | (SP)        | 0000 to 2047 | Always 00 |

**Note** "SP" represents a space (20 Hex).

#### Response Format

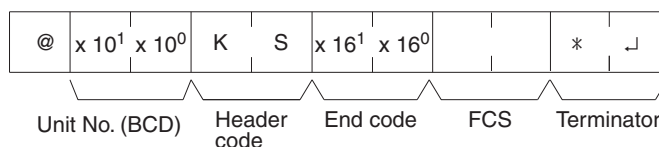

#### Execution Conditions

| Commands |          | Responses |          | PLC Mode |     |      | UM Area         |                |
|----------|----------|-----------|----------|----------|-----|------|-----------------|----------------|
| Single   | Multiple | Single    | Multiple | RUN      | MON | PROG | Write-protected | Read-protected |
| OK       | No       | OK        | No       | No       | OK  | OK   | OK              | OK             |

#### End Codes

An end code of 14 (format error) will be returned if the length of the command is incorrect, or if the bit is designated as other than 00 by the TIM/CNT designation.

An end code of 15 (entry number data error) will be returned if the area classification, word address, or bit parameter setting is out of range (including hexadecimal data).

| End code (Hex) | Contents                                  |
|----------------|---|
| 00             | Normal completion                         |
| 01             | Not executable in RUN mode                |
| 13             | FCS error                                 |
| 14             | Format error                              |
| 15             | Entry number data error                   |
| 18             | Frame length error                        |
| 21             | Not executable due to CPU Unit CPU error. |

### 4-3-27 FORCED RESET -- KR

Force resets the operating status of operands. (Only one bit at a time can be force set.)

#### Command Format

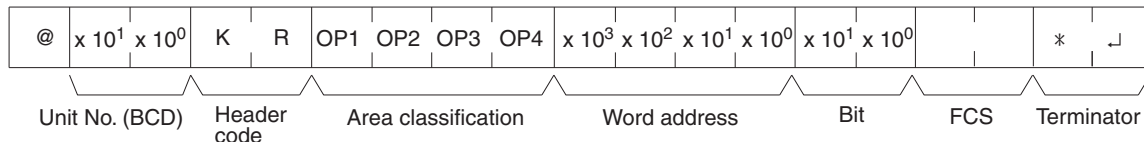

| Classification | Area classification |             |             |             | Word address | Bit       |
|----------------|---------------------|-------------|-------------|-------------|--------------|-----------|
|                | Character 1         | Character 2 | Character 3 | Character 4 |              |           |
| CIO            | C                   | I           | O           | (SP)        | 0000 to 6143 | 00 to 15  |
| LR             | L                   | R           | (SP)        | (SP)        | 0000 to 0199 | 00 to 15  |
| WR             | W                   | R           | (SP)        | (SP)        | 0000 to 0511 | 00 to 15  |
| HR             | H                   | R           | (SP)        | (SP)        | 0000 to 0511 | 00 to 15  |
| Timer          | T                   | I           | M           | (SP)        | 0000 to 2047 | Always 00 |
| Counter        | C                   | N           | T           | (SP)        | 0000 to 2047 | Always 00 |

**Note** "SP" represents a space (20 Hex).

#### Response Format

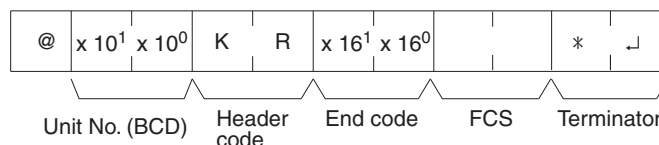

#### Execution Conditions

| Commands |          | Responses |          | PLC Mode |     |      | UM Area         |                |
|----------|----------|-----------|----------|----------|-----|------|-----------------|----------------|
| Single   | Multiple | Single    | Multiple | RUN      | MON | PROG | Write-protected | Read-protected |
| OK       | No       | OK        | No       | No       | OK  | OK   | OK              | OK             |

#### End Codes

An end code of 14 (format error) will be returned if the length of the command is incorrect, or if the bit is designated as other than 00 by the TIM/CNT designation.

An end code of 15 (entry number data error) will be returned if the area classification, word address, or bit parameter setting is out of range (including hexadecimal data).

| End code (Hex) | Contents                                  |
|----------------|---|
| 00             | Normal completion                         |
| 01             | Not executable in RUN mode                |
| 13             | FCS error                                 |
| 14             | Format error                              |
| 15             | Entry number data error                   |
| 18             | Frame length error                        |
| 21             | Not executable due to CPU Unit CPU error. |



### 4-3-28 MULTIPLE FORCED SET/RESET -- FK

Force sets, resets, or cancels the operating status of operands. (Multiple bits can be simultaneously force set, reset, or canceled.)

#### Command Format

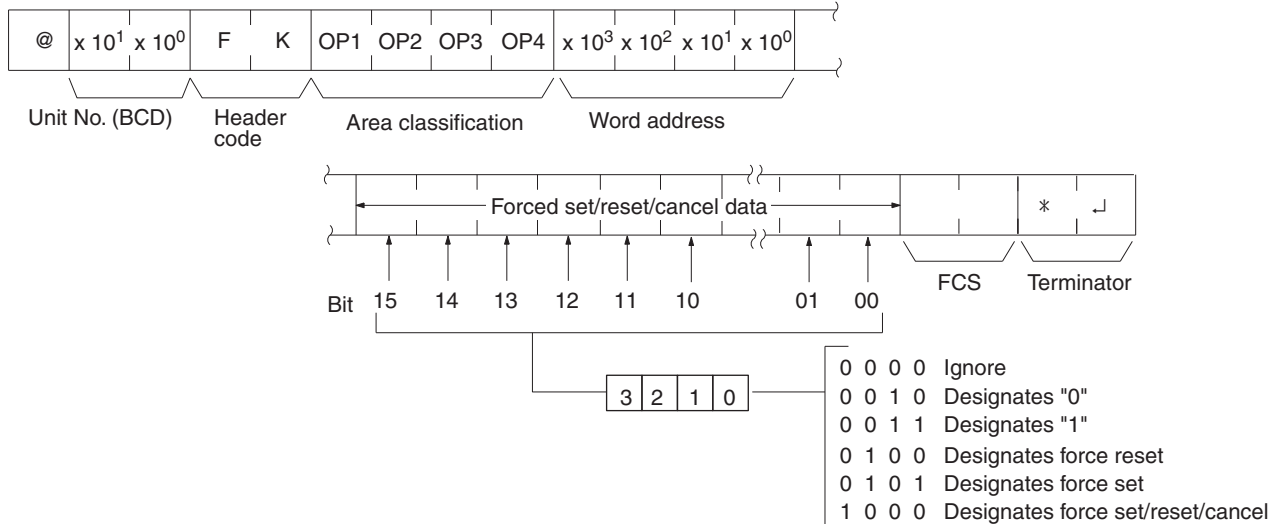

| Classification | Area classification |             |             |             | Word address |
|----------------|---------------------|-------------|-------------|-------------|--------------|
|                | Character 1         | Character 2 | Character 3 | Character 4 |              |
| CIO            | C                   | I           | O           | (SP)        | 0000 to 6143 |
| LR             | L                   | R           | (SP)        | (SP)        | 0000 to 0199 |
| WR             | W                   | R           | (SP)        | (SP)        | 0000 to 0511 |
| HR             | H                   | R           | (SP)        | (SP)        | 0000 to 0511 |
| Timer          | T                   | I           | M           | (SP)        | 0000 to 2047 |
| Counter        | C                   | N           | T           | (SP)        | 0000 to 2047 |

**Note** "SP" represents a space (20 Hex).

#### Response Format

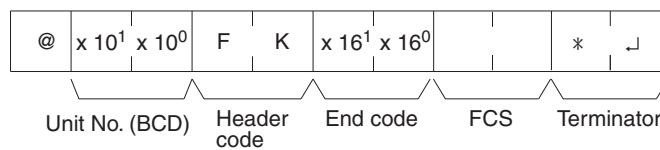

#### Limitations

Only 15 timers/counters can be set/reset.

LR 0000 to LR 0199 correspond to data link bits CIO 1000 to CIO 1199.

#### Execution Conditions

| Commands |          | Responses |          | PLC Mode |     |      | UM Area         |                |
|----------|----------|-----------|----------|----------|-----|------|-----------------|----------------|
| Single   | Multiple | Single    | Multiple | RUN      | MON | PROG | Write-protected | Read-protected |
| OK       | No       | OK        | No       | No       | OK  | OK   | OK              | OK             |

#### End Codes

An end code of 14 (format error) will be returned if the length of the command is incorrect. (The forced set/reset/cancel data is 16 bytes long.)

An end code of 15 (entry number data error) will be returned if the area classification, word address, or bit parameter setting is incorrect. An end code of 15

will also be returned if the a data specification of 0 or 1 is used when a timer or counter is designated.

| End code (Hex) | Contents                                  |
|----------------|---|
| 00             | Normal completion                         |
| 01             | Not executable in RUN mode                |
| 13             | FCS error                                 |
| 14             | Format error                              |
| 15             | Entry number data error                   |
| 18             | Frame length error                        |
| 21             | Not executable due to CPU Unit CPU error. |

### 4-3-29 FORCED SET/RESET CANCEL -- KC

Cancels all forced set and forced reset bits (including those set by FORCED SET, FORCED RESET, and MULTIPLE FORCED SET/RESET).

#### Command Format

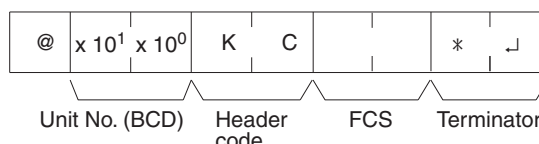

#### Response Format

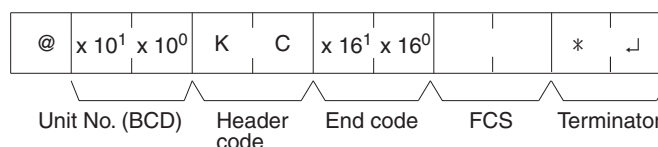

#### Execution Conditions

| Commands |          | Responses |          | PLC Mode |     |      | UM Area         |                |
|----------|----------|-----------|----------|----------|-----|------|-----------------|----------------|
| Single   | Multiple | Single    | Multiple | RUN      | MON | PROG | Write-protected | Read-protected |
| OK       | No       | OK        | No       | No       | OK  | OK   | OK              | OK             |

#### End Codes

An end code of 14 (format error) will be returned if the length of the command is incorrect. (The forced set/reset/cancel data can be 16 bytes long.)

| End code (Hex) | Contents                                  |
|----------------|---|
| 00             | Normal completion                         |
| 01             | Not executable in RUN mode                |
| 13             | FCS error                                 |
| 14             | Format error                              |
| 15             | Entry number data error                   |
| 18             | Frame length error                        |
| 21             | Not executable due to CPU Unit CPU error. |

### 4-3-30 PLC MODEL READ -- MM

Reads the model code of the CPU Unit.

#### Command Format

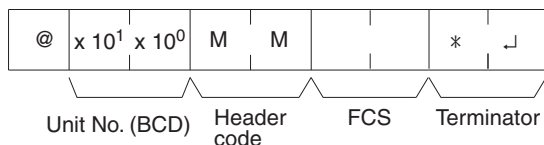

#### Response Format

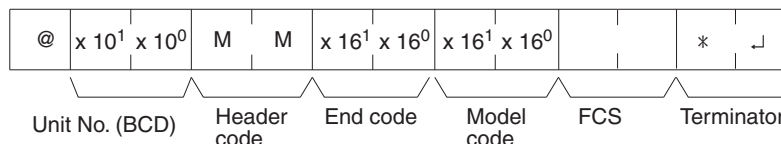

“Model code” indicates the model in two digits hexadecimal.

| Model code | Model   |
|------------|---|
| 30         | CS/CJ   |
| 01         | C250  |
| 02         | C500  |
| 03         | C120/C50  |
| 09         | C250F   |
| 0A         | C500F   |
| 0B         | C120F   |
| 0E         | C2000   |
| 10         | C1000H  |
| 11         | C2000H/CQM1/CPM1                                  |
| 12         | C20H/C28H/C40H, C200H, C200HS, C200HX/HG/HE (-ZE) |
| 20         | CV500   |
| 21         | CV1000  |
| 22         | CV2000  |
| 40         | CVM1-CPU01-E                                      |
| 41         | CVM1-CPU11-E                                      |
| 42         | CVM1-CPU21-E                                      |

#### Execution Conditions

| Commands |          | Responses |          | PLC Mode |     |      | UM Area         |                |
|----------|----------|-----------|----------|----------|-----|------|-----------------|----------------|
| Single   | Multiple | Single    | Multiple | RUN      | MON | PROG | Write-protected | Read-protected |
| OK       | No       | OK        | No       | OK       | OK  | OK   | OK              | OK             |

#### End Codes

An end code of 14 (format error) will be returned if the length of the command is incorrect.

| End code (Hex) | Contents                                  |
|----------------|---|
| 00             | Normal completion                         |
| 13             | FCS error                                 |
| 14             | Format error                              |
| 18             | Frame length error                        |
| 21             | Not executable due to CPU Unit CPU error. |

### 4-3-31 TEST – – TS

Returns, unaltered, one block of data transmitted from the host computer.

#### Command Format

Specify any characters other than the carriage return.

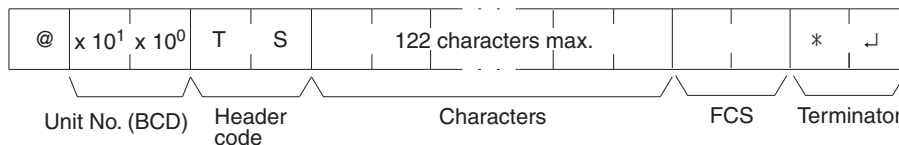

#### Response Format

The same characters specified in the command will be returned unaltered if the test is successful.

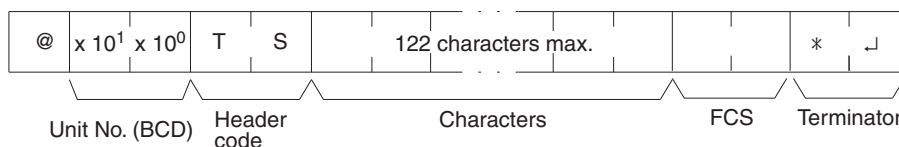

#### Limitations

Between 0 and 122 characters can be sent.

If the command is correct, no end code will be returned.

#### Execution Conditions

| Commands |          | Responses |          | PLC Mode |     |      | UM Area         |                |
|----------|----------|-----------|----------|----------|-----|------|-----------------|----------------|
| Single   | Multiple | Single    | Multiple | RUN      | MON | PROG | Write-protected | Read-protected |
| OK       | No       | OK        | No       | OK       | OK  | OK   | OK              | OK             |

#### End Codes

An end code of 14 (format error) will be returned if a terminator is not received in the first frame.

| End code (Hex) | Contents                                  |
|----------------|---|
| 13             | FCS error                                 |
| 14             | Format error                              |
| 18             | Frame length error                        |
| 21             | Not executable due to CPU Unit CPU error. |

### 4-3-32 PROGRAM READ – – RP

Reads the contents of the CPU Unit user's program area in machine language. The contents are read as a block, from the beginning to the end.

#### Command Format

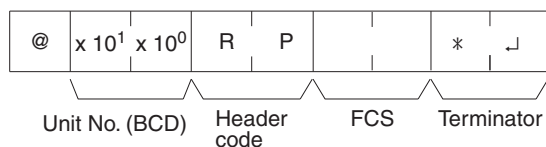

#### Response Format

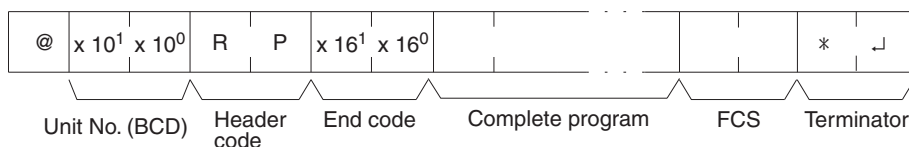

#### Limitations

The command cannot be executed if the UM Area is read-protected.

Data is read from the beginning of the UM Area to the maximum limit of the program area.

The response's first frame will contain 30 words of program data. The second and later frames will contain 31 words except for the last frame, which will contain up to 31 words.

The INITIALIZE and ABORT commands can be sent instead of the delimiter for multiple responses for this command. If other commands are sent, they will be treated as delimiters.

**Execution Conditions**

| Commands |          | Responses |          | PLC Mode |     |      | UM Area         |                |
|----------|----------|-----------|----------|----------|-----|------|-----------------|----------------|
| Single   | Multiple | Single    | Multiple | RUN      | MON | PROG | Write-protected | Read-protected |
| OK       | No       | OK        | OK       | OK       | OK  | OK   | OK              | No             |

**End Codes**

An end code of 14 (format error) will be returned if the length of the command is incorrect.

| End code (Hex) | Contents                                  |
|----------------|---|
| 00             | Normal completion                         |
| 13             | FCS error                                 |
| 14             | Format error                              |
| 18             | Frame length error                        |
| 19             | Not executable                            |
| 21             | Not executable due to CPU Unit CPU error. |
| 23             | User memory protected                     |

**4-3-33 PROGRAM WRITE -- WP**

Writes to the CPU Unit user's program area the machine language program transmitted from the host computer. The contents are written as a block, from the beginning.

**Command Format**

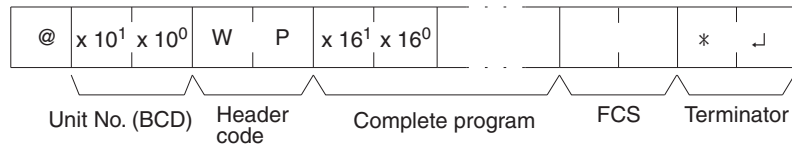

**Response Format**

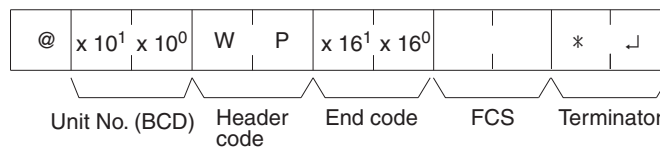

**Limitations**

The command cannot be executed while the UM Area is write-protected. Data is written from the beginning of the UM Area to the maximum limit of the program area.

An error will not occur if the command attempts to write program data beyond the maximum size of the program area.

The program data can be divided into multiple frames in units of 4 characters.

**Execution Conditions**

| Commands |          | Responses |          | PLC Mode |     |      | UM Area         |                |
|----------|----------|-----------|----------|----------|-----|------|-----------------|----------------|
| Single   | Multiple | Single    | Multiple | RUN      | MON | PROG | Write-protected | Read-protected |
| OK       | OK       | OK        | No       | No       | No  | OK   | No              | OK             |

**End Codes**

An end code of 14 (format error) will be returned if the length of the command is incorrect (the total size of the program is not a multiple of 8 bytes) or the first frame contains no program data.

An end code of 15 (entry number data error) will be returned if the specified write data is not hexadecimal.

| End code (Hex) | Contents  |
|----------------|---|
| 00             | Normal completion                                       |
| 01             | Not executable in RUN mode                              |
| 02             | Not executable in MONITOR mode                          |
| 13             | FCS error   |
| 14             | Format error  |
| 15             | Entry number data error                                 |
| 18             | Frame length error                                      |
| 19             | Not executable  |
| 21             | Not executable due to CPU Unit CPU error.               |
| 23             | User memory protected                                   |
| A3             | Aborted due to FCS error in transmit data               |
| A4             | Aborted due to format error in transmit data            |
| A5             | Aborted due to entry number data error in transmit data |
| A8             | Aborted due to frame length error in transmit data      |

**4-3-34 I/O TABLE GENERATE -- MI**

Corrects the registered I/O table to match the actual I/O table.

**Command Format**

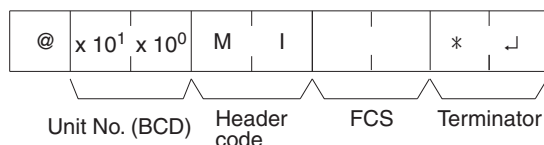

**Response Format**

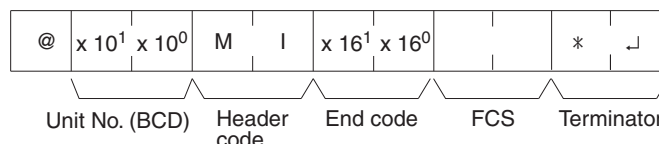

**Limitations**

The UM write-protected end code for this command is different from that of the other commands.

**Execution Conditions**

| Commands |          | Responses |          | PLC Mode |     |      | UM Area         |                |
|----------|----------|-----------|----------|----------|-----|------|-----------------|----------------|
| Single   | Multiple | Single    | Multiple | RUN      | MON | PROG | Write-protected | Read-protected |
| OK       | No       | OK        | No       | No       | No  | OK   | No              | OK             |

**End Codes**

An end code of 14 (format error) will be returned if the length of the command is incorrect.

| End code (Hex) | Contents                       |
|----------------|--------------------------------|
| 00             | Normal completion              |
| 01             | Not executable in RUN mode     |
| 02             | Not executable in MONITOR mode |
| 03             | UM write-protected             |
| 13             | FCS error                      |

| End code (Hex) | Contents                                  |
|----------------|---|
| 14             | Format error                              |
| 18             | Frame length error                        |
| 19             | Not executable                            |
| 20             | Could not create I/O table                |
| 21             | Not executable due to CPU Unit CPU error. |

### 4-3-35 REGISTER I/O MEMORY -- QQMR

Pre-registers to the table all of the I/O memory area bits, words, and timers/counters that are to be read. The registered contents are retained until they are overwritten or until the power is cut off, so they can be read by QQIR. (Refer to 4-3-36 READ I/O MEMORY -- QQIR.)

#### Command Format

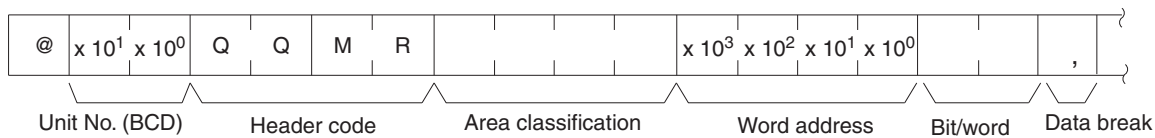

Bit/word  
 00 to 15: Bit designation (BCD)  
 CH: Word data designation (ON/  
 OFF data only when other than word is  
 designated by T/C.)

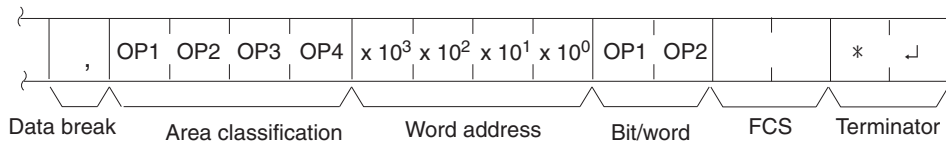

| Classification  | Area classification |             |             |             | Word address (BCD) |
|-----------------|---------------------|-------------|-------------|-------------|--------------------|
|                 | Charac-ter1         | Charac-ter2 | Charac-ter3 | Charac-ter4 |                    |
| CIO             | C                   | I           | O           | (SP)        | 0000 to 6143       |
| LR              | L                   | R           | (SP)        | (SP)        | 0000 to 0199       |
| AR              | A                   | R           | (SP)        | (SP)        | 0000 to 0959       |
| HR              | H                   | R           | (SP)        | (SP)        | 0000 to 0511       |
| WR              | W                   | R           | (SP)        | (SP)        | 0000 to 0511       |
| Timer           | T                   | I           | M           | (SP)        | 0000 to 2047       |
| Counter         | C                   | N           | T           | (SP)        | 0000 to 2047       |
| DM              | D                   | M           | (SP)        | (SP)        | 0000 to 9999       |
| EM current bank | E                   | M           | (SP)        | (SP)        | 0000 to 9999       |
| EM banks 0 to C | E                   | M           | 0           | 0           | 0000 to 9999       |
|                 | to                  |             |             |             |                    |
|                 | E                   | M           | 0           | C           |                    |

**Note** "SP" represents a space (20 Hex).

#### Response Format

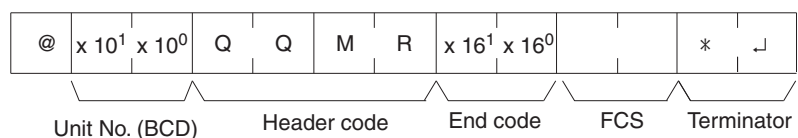

#### Limitations

LR 0000 to LR 0199 correspond to data link bits CIO 1000 to CIO 1199.

The maximum number of items that can be registered is 128, and timer/counter word designation is counted as two items.

If all of the registered data is correct, it will be registered to the table.

EM can be read through the current bank or bank designation.

The maximum EM bank number that can be specified is 12 (0C Hex).

Bits and words can be specified in any order and they will be registered in the order that they were specified.

The data can be divided into multiple frames.

**Execution Conditions**

| Commands |          | Responses |          | PLC Mode |     |      | UM Area         |                |
|----------|----------|-----------|----------|----------|-----|------|-----------------|----------------|
| Single   | Multiple | Single    | Multiple | RUN      | MON | PROG | Write-protected | Read-protected |
| OK       | OK       | OK        | No       | OK       | OK  | OK   | OK              | OK             |

**End Codes**

An end code of 14 (format error) will be returned if the “,” data break between two items is omitted. (The command will be considered correct if there is a “,” data break just before the FCS or at the beginning of a multiple-frame command.)

An end code of 15 (entry number data error) will be returned if the area classification, word address, or bit/word setting is out of range (including hexadecimal data).

| End code (Hex) | Contents  |
|----------------|---|
| 00             | Normal completion                                       |
| 13             | FCS error   |
| 14             | Format error  |
| 15             | Entry number data error                                 |
| 18             | Frame length error                                      |
| 19             | Not executable  |
| A3             | Aborted due to FCS error in transmit data               |
| A4             | Aborted due to format error in transmit data            |
| A5             | Aborted due to entry number data error in transmit data |
| A8             | Aborted due to frame length error in transmit data      |

**4-3-36 READ I/O MEMORY -- QQIR**

Reads the word and bit data, from multiple I/O memory areas, that was registered with QQMR.

**Command Format**

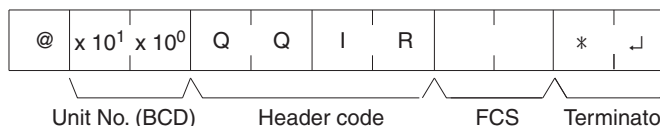



Response Format

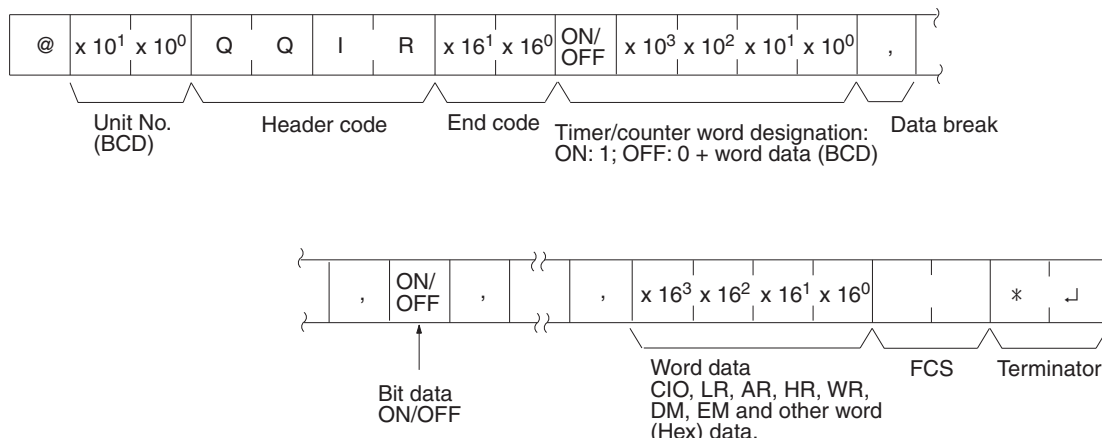

Limitations

The data is read in the same order in which it was registered with QQMR.

Execution Conditions

| Commands |          | Responses |          | PLC Mode |     |      | UM Area         |                |
|----------|----------|-----------|----------|----------|-----|------|-----------------|----------------|
| Single   | Multiple | Single    | Multiple | RUN      | MON | PROG | Write-protected | Read-protected |
| OK       | No       | OK        | OK       | OK       | OK  | OK   | OK              | OK             |

End Codes

An end code of 14 (format error) will be returned if the length of the command is incorrect.

An end code of 19 (not executable) will be returned if there is no registered data.

| End code (Hex) | Contents                                  |
|----------------|---|
| 00             | Normal completion                         |
| 13             | FCS error                                 |
| 14             | Format error                              |
| 18             | Frame length error                        |
| 19             | Not executable                            |
| 21             | Not executable due to CPU Unit CPU error. |

4-3-37 ABORT -- XZ

Aborts the Host Link command that is currently being processed, allowing the next command to be received.

Command Format

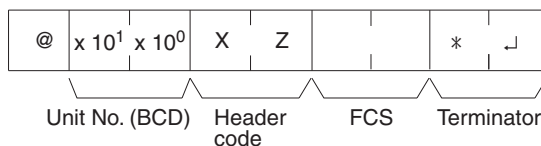

Limitations

Multiple responses to a command can be cancelled with this command.

An FCS code and terminator are required.

End Codes

The ABORT command does not receive a response.

**End Codes** There are no end codes with this command. (There is no response).  
 If the ABORT command (XZ) is received when data is being sent from a serial port to a host, the send operation will be stopped even in the middle of a frame.

**4-3-38 INITIALIZE -- \*\***

Initializes the transmission control procedure of the Units at all the unit numbers.

**Command Format**



**Limitations** Multiple responses to a command can be cancelled with this command.  
 The INITIALIZE command does not receive a response.

**End Codes** There are no end codes with this command. (There is no response).

**4-3-39 Undefined Command -- IC**

This response is returned if the header code of a command cannot be decoded.

**Response Format**

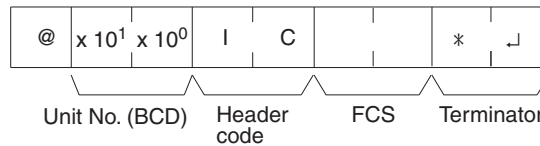

**Limitations** This response will be returned as an error for illegal header codes.  
 This response will be returned for error frames as well.  
 There is no command associated with IC.

**End Codes** There are no end codes with this command.

## SECTION 5 FINS Commands

This section provides detailed descriptions of the FINS commands.

|        |  |     |
|--------|--|-----|
| 5-1    | Command Lists .....  | 150 |
| 5-1-1  | FINS Commands .....  | 150 |
| 5-1-2  | FINS Command Restrictions .....                                  | 153 |
| 5-1-3  | End Codes .....  | 155 |
| 5-2    | Designating Command Parameters .....                             | 163 |
| 5-2-1  | Designating I/O Memory (Variable) Area Addresses .....           | 163 |
| 5-2-2  | I/O Memory Address Designations .....                            | 165 |
| 5-3    | FINS Commands .....  | 170 |
| 5-3-1  | About this Section .....   | 170 |
| 5-3-2  | MEMORY AREA READ: 01 01 .....                                    | 171 |
| 5-3-3  | MEMORY AREA WRITE: 01 02 .....                                   | 174 |
| 5-3-4  | MEMORY AREA FILL: 01 03 .....                                    | 175 |
| 5-3-5  | MULTIPLE MEMORY AREA READ: 01 04 .....                           | 177 |
| 5-3-6  | MEMORY AREA TRANSFER: 01 05 .....                                | 180 |
| 5-3-7  | PARAMETER AREA READ: 02 01 .....                                 | 181 |
| 5-3-8  | PARAMETER AREA WRITE: 02 02 .....                                | 182 |
| 5-3-9  | PARAMETER AREA CLEAR: 02 03 .....                                | 184 |
| 5-3-10 | PROGRAM AREA READ: 03 06 .....                                   | 185 |
| 5-3-11 | PROGRAM AREA WRITE: 03 07 .....                                  | 186 |
| 5-3-12 | PROGRAM AREA CLEAR: 03 08 .....                                  | 187 |
| 5-3-13 | RUN: 04 01 .....   | 189 |
| 5-3-14 | STOP: 04 02 .....  | 189 |
| 5-3-15 | CPU UNIT DATA READ: 05 01 .....                                  | 190 |
| 5-3-16 | CONNECTION DATA READ: 05 02 .....                                | 193 |
| 5-3-17 | CPU UNIT STATUS READ: 06 01 .....                                | 194 |
| 5-3-18 | CYCLE TIME READ: 06 20 .....                                     | 196 |
| 5-3-19 | CLOCK READ: 07 01 .....  | 197 |
| 5-3-20 | CLOCK WRITE: 07 02 .....   | 198 |
| 5-3-21 | MESSAGE READ: 09 20 .....  | 199 |
| 5-3-22 | MESSAGE CLEAR: 09 20 .....                                       | 200 |
| 5-3-23 | FAL/FALS READ: 09 20 .....                                       | 201 |
| 5-3-24 | ACCESS RIGHT ACQUIRE: 0C 01 .....                                | 202 |
| 5-3-25 | ACCESS RIGHT FORCED ACQUIRE: 0C 02 .....                         | 204 |
| 5-3-26 | ACCESS RIGHT RELEASE: 0C 03 .....                                | 206 |
| 5-3-27 | ERROR CLEAR: 21 01 .....   | 207 |
| 5-3-28 | ERROR LOG READ: 21 02 .....                                      | 208 |
| 5-3-29 | ERROR LOG CLEAR: 21 03 .....                                     | 210 |
| 5-3-30 | FINS WRITE ACCESS LOG READ: 21 40 .....                          | 210 |
| 5-3-31 | FINS WRITE ACCESS LOG CLEAR: 21 41 .....                         | 212 |
| 5-3-32 | FILE NAME READ: 22 01 .....                                      | 212 |
| 5-3-33 | SINGLE FILE READ: 22 02 .....                                    | 215 |
| 5-3-34 | SINGLE FILE WRITE: 22 03 .....                                   | 216 |
| 5-3-35 | FILE MEMORY FORMAT: 22 04 .....                                  | 217 |
| 5-3-36 | FILE DELETE: 22 05 .....   | 218 |
| 5-3-37 | FILE COPY: 22 07 .....   | 219 |
| 5-3-38 | FILE NAME CHANGE: 22 08 .....                                    | 220 |
| 5-3-39 | MEMORY AREA-FILE TRANSFER: 22 0A .....                           | 221 |
| 5-3-40 | PARAMETER AREA-FILE TRANSFER: 22 0B .....                        | 223 |
| 5-3-41 | PROGRAM AREA-FILE TRANSFER: 22 0C .....                          | 225 |
| 5-3-42 | CREATE/DELETE DIRECTORY: 22 15 .....                             | 227 |
| 5-3-43 | MEMORY CASSETTE TRANSFER (CP-series CPU Units Only): 22 20 ..... | 228 |
| 5-3-44 | FORCED SET/RESET: 23 01 .....                                    | 229 |
| 5-3-45 | FORCED SET/RESET CANCEL: 23 02 .....                             | 231 |
| 5-3-46 | CONVERT TO COMPOWAY/F COMMAND: 28 03 .....                       | 231 |
| 5-3-47 | CONVERT TO MODBUS-RTU COMMAND: 28 04 .....                       | 234 |
| 5-3-48 | CONVERT TO MODBUS-ASCII COMMAND: 28 05 .....                     | 236 |

## 5-1 Command Lists

### 5-1-1 FINS Commands

The following table lists the FINS commands.

| Type                          | Command code |    | Name                                    | Function   |
|-------------------------------|--------------|----|---|--|
|                               | MR           | SR |   |  |
| I/O memory area access        | 01           | 01 | MEMORY AREA READ                        | Reads the contents of consecutive I/O memory area words.                             |
|                               | 01           | 02 | MEMORY AREA WRITE (See note.)           | Writes the contents of consecutive I/O memory area words.                            |
|                               | 01           | 03 | MEMORY AREA FILL (See note.)            | Writes the same data to the specified range of I/O memory area words.                |
|                               | 01           | 04 | MULTIPLE MEMORY AREA READ               | Reads the contents of specified non-consecutive I/O memory area words.               |
|                               | 01           | 05 | MEMORY AREA TRANSFER (See note.)        | Copies the contents of consecutive I/O memory area words to another I/O memory area. |
| Parameter area access         | 02           | 01 | PARAMETER AREA READ                     | Reads the contents of consecutive parameter area words.                              |
|                               | 02           | 02 | PARAMETER AREA WRITE (See note.)        | Writes the contents of consecutive parameter area words.                             |
|                               | 02           | 03 | PARAMETER AREA FILL (CLEAR) (See note.) | Writes the same data to the specified range of parameter area words.                 |
| Program area access           | 03           | 06 | PROGRAM AREA READ                       | Reads the UM (User Memory) area.   |
|                               | 03           | 07 | PROGRAM AREA WRITE (See note.)          | Writes to the UM (User Memory) area.   |
|                               | 03           | 08 | PROGRAM AREA CLEAR (See note.)          | Clears the UM (User Memory) area.  |
| Operating mode changes        | 04           | 01 | RUN (See note.)                         | Changes the CPU Unit's operating mode to RUN or MONITOR.                             |
|                               | 04           | 02 | STOP (See note.)                        | Changes the CPU Unit's operating mode to PROGRAM.                                    |
| Machine configuration reading | 05           | 01 | CPU UNIT DATA READ                      | Reads CPU Unit data.   |
|                               | 05           | 02 | CONNECTION DATA READ                    | Reads the model numbers of the device corresponding to addresses.                    |
| Status reading                | 06           | 01 | CPU UNIT STATUS READ                    | Reads the status of the CPU Unit.  |
|                               | 06           | 20 | CYCLE TIME READ                         | Reads the maximum, minimum, and average cycle time.                                  |
| Time data access              | 07           | 01 | CLOCK READ                              | Reads the present year, month, date, minute, second, and day of the week.            |
|                               | 07           | 02 | CLOCK WRITE (See note.)                 | Changes the present year, month, date, minute, second, or day of the week.           |
| Message display               | 09           | 20 | MESSAGE READ/CLEAR                      | Reads and clears messages, and reads FAL/FALS messages.                              |
| Access rights                 | 0C           | 01 | ACCESS RIGHT ACQUIRE (See note.)        | Acquires the access right as long as no other device holds it.                       |
|                               | 0C           | 02 | ACCESS RIGHT FORCED ACQUIRE             | Acquires the access right even if another device already holds it.                   |
|                               | 0C           | 03 | ACCESS RIGHT RELEASE                    | Releases the access right that has been acquired.                                    |
| Error log                     | 21           | 01 | ERROR CLEAR (See note.)                 | Clears errors or error messages.   |
|                               | 21           | 02 | ERROR LOG READ                          | Reads the error log.   |
|                               | 21           | 03 | ERROR LOG CLEAR (See note.)             | Clears the error log pointer.  |

| Type                     | Command code |     | Name   | Function  |
|--------------------------|--------------|-----|--|---|
|                          | MR           | SR  |  |   |
| FINS write access log    | 21           | 40  | FINS WRITE ACCESS LOG READ                                     | The CPU Unit automatically keeps a log of any access for FINS write commands. This command reads this log.  |
|                          | 21           | 41  | FINS WRITE ACCESS LOG CLEAR (See note.)                        | Clears the FINS write access log.   |
| File memory              | 22           | 01  | FILE NAME READ   | Reads file memory data.   |
|                          | 22           | 02  | SINGLE FILE READ   | Reads a specified length of file data from a specified position within a single file.   |
|                          | 22           | 03  | SINGLE FILE WRITE (See note.)                                  | Writes a specified length of file data from a specified position within a single file.  |
|                          | 22           | 04  | FILE MEMORY FORMAT (See note.)                                 | Formats (initializes) the file memory.  |
|                          | 22           | 05  | FILE DELETE (See note.)  | Deletes specified files stored in the file memory.  |
|                          | 22           | 07  | FILE COPY (See note.)  | Copies files from one file memory to another file memory in the same system.  |
|                          | 22           | 08  | FILE NAME CHANGE (See note.)                                   | Changes a file name.  |
|                          | 22           | 0A  | MEMORY AREA-FILE TRANSFER (See note.)                          | Transfers or compares data between the I/O memory area and the file memory.   |
|                          | 22           | 0B  | PARAMETER AREA-FILE TRANSFER (See note.)                       | Transfers or compares data between the parameter area and the file memory.  |
|                          | 22           | 0C  | PROGRAM AREA-FILE TRANSFER (See note.)                         | Transfers or compares data between the UM (User Memory) area and the file memory.   |
|                          | 22           | 15  | DIRECTORY CREATE/DELETE (See note.)                            | Creates or deletes a directory.   |
|                          | 22           | 20  | MEMORY CASSETTE TRANSFER (CP1H CPU Units, CP1L CPU Units only) | Transfers and verifies data between a Memory Cassette and the CPU Unit.   |
| Debugging                | 23           | 01  | FORCED SET/RESET (See note.)                                   | Force-sets or force-resets bits, or releases force-set status.  |
|                          | 23           | 02  | FORCED SET/RESET CANCEL (See note.)                            | Cancels all bits that have been force-set or force-reset.   |
| Serial Gateway functions | 28           | 03  | CONVERT TO COMPOWAY/F COMMAND                                  | Encapsulates a CompoWay/F command in a FINS command and sends it to a serial port. (The CompoWay/F command is extracted and sent through the serial port at the receiving end.)     |
|                          | 28           | 04  | CONVERT TO MODBUS-RTU COMMAND                                  | Encapsulates a Modbus-RTU command in a FINS command and sends it to a serial port. (The Modbus-RTU command is extracted and sent through the serial port at the receiving end.)     |
|                          | 28           | 05  | CONVERT TO MODBUS-ASCII COMMAND                                | Encapsulates a Modbus-ASCII command in a FINS command and sends it to a serial port. (The Modbus-ASCII command is extracted and sent through the serial port at the receiving end.) |
|                          | Any          | Any | CONVERT TO HOST LINK FINS COMMAND (See note 2.)                | Sends any FINS command to a PLC connected to the serial port of a Serial Communications Board or Unit (Ver. 1.2 or later only).   |

- Note**
1. These commands will not be accepted and an end code of 2102 hex (cannot write due to protection) will be returned if the *Write Protection from FINS Commands Sent to CPU Units via Networks* option is selected in the PLC Setup for CS1-H CPU Units, CJ1-H CPU Units, CJ1M CPU Units, CS1D CPU Units (for Single CPU Systems) with unit version 2.0 or later, CP-series CPU Units, or NSJ Controllers.
  2. The Serial Gateway function can be used with Host Link FINS commands only under the following conditions.  
For more details, refer to *3-5 FINS Commands with Host Link Protocol* and the *CS/CJ Series Serial Communications Boards and Serial Communications Units Operation Manual (W336-E1-05)*.

#### **Connecting to the Destination PLC**

Connect the destination PLC to the serial port of a Serial Communications Unit or Board (Ver. 1.2 or later) as a Host Link Slave and use the serial gateway mode or protocol macro mode communications.

#### **Specifying the Destination PLC's FINS Address**

- Destination Network Address (DNA):
  - When a routing table is created to treat the serial communications path as a network, the routing table associates this network address with the Serial Communications Unit or Board's serial port.
  - When a routing table is **not** created to treat the serial communications path as a network, this is the unit address of the Serial Communications Unit or Board's serial port.
- Destination Node Address (DA1):
  - When a routing table is created to treat the serial communications path as a network, the node address is the Host Link unit number + 1 (values 1 to 32).
  - When a routing table is **not** created to treat the serial communications path as a network, the node address is still the Host Link unit number + 1 (values 1 to 32).
- Destination Unit Address (DA2):  
Specifies any unit address other than the serial port. (The destination of a FINS message must be an address other than the Serial Communications Unit or Board's serial port.)

5-1-2 FINS Command Restrictions

| Type                          | Command code |    | Name                        | PLC status |              |              |                               |                 |                                |                              |
|-------------------------------|--------------|----|-----------------------------|------------|--------------|--------------|-------------------------------|-----------------|--------------------------------|------------------------------|
|                               | MR           | SR |                             | RUN mode   | MONITOR mode | PROGRAM mode | Access right                  | Read protection | DIP switch UM write-protection | Write-protected from network |
| I/O memory area access        | 01           | 01 | MEMORY AREA READ            | OK         | OK           | OK           | OK                            | OK              | OK                             | OK                           |
|                               |              | 02 | MEMORY AREA WRITE           | OK         | OK           | OK           | OK                            | OK              | OK                             | Disabled                     |
|                               |              | 03 | MEMORY AREA FILL            | OK         | OK           | OK           | OK                            | OK              | OK                             | Disabled                     |
|                               |              | 04 | MULTIPLE MEMORY AREA READ   | OK         | OK           | OK           | OK                            | OK              | OK                             | OK                           |
|                               |              | 05 | MEMORY AREA TRANSFER        | OK         | OK           | OK           | OK                            | OK              | OK                             | Disabled                     |
| Parameter area access         | 02           | 01 | PARAMETER AREA READ         | OK         | OK           | OK           | OK                            | OK              | OK                             | OK                           |
|                               |              | 02 | PARAMETER AREA WRITE        | OK         | OK           | OK           | Disabled                      | OK              | Disabled                       | Disabled                     |
|                               |              | 03 | PARAMETER AREA CLEAR        | OK         | OK           | OK           | Disabled                      | OK              | Disabled                       | Disabled                     |
| Program area access           | 03           | 06 | PROGRAM AREA READ           | OK         | OK           | OK           | OK                            | Disabled        | OK                             | OK                           |
|                               |              | 07 | PROGRAM AREA WRITE          | Disabled   | Disabled     | OK           | Disabled                      | OK              | Disabled                       | Disabled                     |
|                               |              | 08 | PROGRAM AREA CLEAR          | Disabled   | Disabled     | OK           | Disabled                      | OK              | Disabled                       | Disabled                     |
| Operating mode changes        | 04           | 01 | RUN                         | OK         | OK           | OK           | Disabled                      | OK              | OK                             | Disabled                     |
|                               |              | 02 | STOP                        | OK         | OK           | OK           | Disabled                      | OK              | OK                             | Disabled                     |
| Machine configuration reading | 05           | 01 | CPU UNIT DATA READ          | OK         | OK           | OK           | OK                            | OK              | OK                             | OK                           |
|                               |              | 02 | CONNECTION DATA READ        | OK         | OK           | OK           | OK                            | OK              | OK                             | OK                           |
| Status reading                | 06           | 01 | CPU UNIT STATUS READ        | OK         | OK           | OK           | OK                            | OK              | OK                             | OK                           |
|                               |              | 20 | CYCLE TIME READ             | OK         | OK           | Disabled     | OK                            | OK              | OK                             | OK                           |
| Time data access              | 07           | 01 | CLOCK READ                  | OK         | OK           | OK           | OK                            | OK              | OK                             | OK                           |
|                               |              | 02 | CLOCK WRITE                 | OK         | OK           | OK           | Disabled                      | OK              | OK                             |                              |
| Message display               | 09           | 20 | MESSAGE READ/CLEAR          | OK         | OK           | OK           | Disabled (MESSAGE CLEAR only) | OK              | OK                             | Disabled                     |
| Access rights                 | 0C           | 01 | ACCESS RIGHT ACQUIRE        | OK         | OK           | OK           | Disabled                      | OK              | OK                             | Disabled                     |
|                               |              | 02 | ACCESS RIGHT FORCED ACQUIRE | OK         | OK           | OK           | OK                            | OK              | OK                             | OK                           |
|                               |              | 03 | ACCESS RIGHT RELEASE        | OK         | OK           | OK           | OK                            | OK              | OK                             | OK                           |
| Error log                     | 21           | 01 | ERROR CLEAR                 | OK         | OK           | OK           | Disabled                      | OK              | OK                             | Disabled                     |
|                               |              | 02 | ERROR LOG READ              | OK         | OK           | OK           | OK                            | OK              | OK                             | OK                           |
|                               |              | 03 | ERROR LOG CLEAR             | OK         | OK           | OK           | OK                            | OK              | OK                             | Disabled                     |

| Type                  | Command code   |          | Name                              | PLC status                        |              |              |              |                 |                                |                              |
|-----------------------|--|----------|-----------------------------------|-----------------------------------|--------------|--------------|--------------|-----------------|--------------------------------|------------------------------|
|                       | MR   | SR       |                                   | RUN mode                          | MONITOR mode | PROGRAM mode | Access right | Read protection | DIP switch UM write-protection | Write-protected from network |
| FINS write access log | 21   | 40       | FINS WRITE ACCESS LOG READ        | OK                                | OK           | OK           | OK           | OK              | OK                             | OK                           |
|                       | 21   | 41       | FINS WRITE ACCESS LOG CLEAR       | OK                                | OK           | OK           | Disabled     | OK              | OK                             | Disabled                     |
| File memory           | 22   | 01       | FILE NAME READ                    | OK                                | OK           | OK           | OK           | OK              | OK                             | OK                           |
|                       |  | 02       | SINGLE FILE READ                  | OK                                | OK           | OK           | OK           | OK              | OK                             | OK                           |
|                       |  | 03       | SINGLE FILE WRITE                 | OK                                | OK           | OK           | Disabled     | OK              | OK                             | Disabled                     |
|                       |  | 04       | FILE MEMORY FORMAT                | OK                                | OK           | OK           | Disabled     | OK              | OK                             | Disabled                     |
|                       |  | 05       | FILE DELETE                       | OK                                | OK           | OK           | Disabled     | OK              | OK                             | Disabled                     |
|                       |  | 07       | FILE COPY                         | OK                                | OK           | OK           | Disabled     | OK              | OK                             | Disabled                     |
|                       |  | 08       | FILE NAME CHANGE                  | OK                                | OK           | OK           | Disabled     | OK              | OK                             | Disabled                     |
|                       |  | 0A       | MEMORY AREA-FILE TRANSFER         | OK                                | OK           | OK           | Disabled     | OK              | OK                             | Disabled                     |
|                       |  | 0B       | PARAMETER AREA-FILE TRANSFER      | OK (note 1)                       | OK (note 1)  | OK           | Disabled     | OK              | OK (note 1)                    | Disabled                     |
|                       |  | 0C       | PROGRAM AREA-FILE TRANSFER        | OK (note 2)                       | OK (note 2)  | OK           | Disabled     | OK              | Disabled (note 3)              | Disabled                     |
|                       |  | 15       | CREATE/DELETE DIRECTORY           | OK                                | OK           | OK           | Disabled     | OK              | OK                             | Disabled                     |
| 20                    | MEMORY CASSETTE TRANSFER (CP1H CPU Units, CP1L CPU Units only) | Disabled | Disabled                          | OK                                | Disabled     | OK           | OK (note 4)  | Disabled        |                                |                              |
| Debugging             | 23   | 01       | FORCED SET/RESET                  | Disabled                          | OK           | OK           | OK           | OK              | OK                             | Disabled                     |
|                       |  | 02       | FORCED SET/RESET CANCEL           | Disabled                          | OK           | OK           | OK           | OK              | OK                             | Disabled                     |
| Serial Gateway        | 28   | 03       | CONVERT TO COMPOWAY/F COMMAND     | OK                                | OK           | OK           | OK           | OK              | OK                             | OK                           |
|                       |  | 04       | CONVERT TO MODBUS-RTU COMMAND     | OK                                | OK           | OK           | OK           | OK              | OK                             | OK                           |
|                       |  | 05       | CONVERT TO MODBUS-ASCII COMMAND   | OK                                | OK           | OK           | OK           | OK              | OK                             | OK                           |
|                       | Any  | Any      | CONVERT TO HOST LINK FINS COMMAND | Depends on the command code used. |              |              |              |                 |                                |                              |

- Note**
1. File-to-memory area transfers are not possible
  2. File-to-program area transfers are not possible
  3. Program area-to-file transfers are possible
  4. Memory Cassette contents cannot be transferred to the program area if program area data is included.
  5. With CS1-H CPU Units, CJ1-H CPU Units, CJ1M CPU Units, CS1D CPU Units (for Single CPU Systems) with unit version 2.0 or later, CP-series CPU Units, or NSJ Controllers, an option is available in the PLC Setup (Write Protection from FINS Commands Sent to CPU Units via Networks) to not receive FINS write commands from specified network nodes even if a FINS write command is sent to the CPU Unit. The FINS write commands are the ones listed as *Disabled* in the *Write-protected from network* column



above. The enables creating a system in which write/control operations are possible only from specific nodes. For details, refer to *1-4-4 Write Protection from FINS Commands Sent to CPU Units via Networks* in the *CS Series PLC Operation Manual* or the *CJ Series PLC Operation Manual*.

### 5-1-3 End Codes

The following table lists the main codes and the sub-codes, which combine to form the end code (response code) returned for a FINS command. The probable cause and corrections for each error code are also given.

Depending on the command, the destination code will sometimes make a request of another node on a network. The other node is referred to as the third node.

**Note** In addition to the end codes listed in the following table, the specific flags in the end code word (bits 6, 7, and 15) may also be ON. If bit 15 is ON, an error has occurred during a network relay operation. If bit 6 or 7 is ON, an error has occurred in the destination CPU Unit. If this occurs, refer to the operation manuals for the CPU Unit where the error occurred and remove the cause of the error. The contents of the end code word are shown in the following diagram.

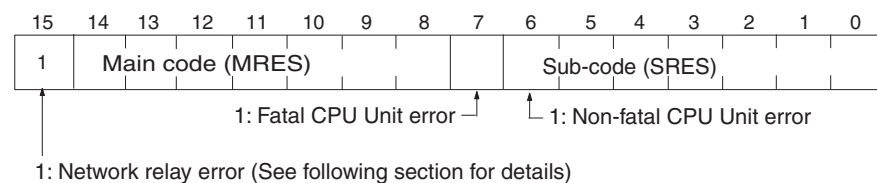

| Main code             | Sub-code                      | Check point                   | Probable cause  | Correction  |
|-----------------------|-------------------------------|-------------------------------|---|---|
| 00: Normal completion | 00: Normal completion         | ---                           | ---   | ---   |
|                       | 01: Service canceled          | ---                           | Service was canceled.   | Check the capacity of the destination area in the third node.   |
|                       |                               | Data link status              | Service was canceled.   | Check the status of the data link.  |
| 01: Local node error  | 01: Local node not in network | Network status of local node  | Local node is not participating in the network.               | Connect the node to the network.  |
|                       | 02: Token timeout             | Maximum node address          | Token does not arrive.  | Set the local node to within the maximum node address.  |
|                       | 03: Retries failed            | ---                           | Send was not possible during the specified number of retries. | Execute a communications test between the nodes and re-examine the system environment if it fails.  |
|                       | 04: Too many send frames      | Number of enabled send frames | Cannot send because maximum number of event frames exceeded.  | Check event execution on the network and reduce the number of events per cycle.<br>Increase the maximum number of event frames.                   |
|                       | 05: Node address range error  | Node address                  | Node address setting error occurred.                          | Check the settings of the rotary switches to be sure that the address is within range and that each address is set only once in the same network. |
|                       | 06: Node address duplication  | Node addresses                | The same node address has been set twice in the same network. | Change the address of one of the nodes with the same address.   |

| <b>Main code</b>                          | <b>Sub-code</b>                     | <b>Check point</b>                      | <b>Probable cause</b>   | <b>Correction</b>   |   |
|---|-------------------------------------|---|---|---|---|
| 02: Destination node error                | 01: Destination node not in network | INS indicator on Unit                   | The destination node is not in the network.                                   | Add the destination node to the network.  |   |
|   | 02: Unit missing                    | Instruction control data                | There is no Unit with the specified unit address.                             | Check the destination unit address.   |   |
|   | 03: Third node missing              | Instruction control data                | The third node does not exist.  | Check the unit address of the third node. Check the node address of the third node in the send data for CMND(490).      |   |
|   |                                     |   | Command data  | Broadcasting was specified.   | Specify only one node for the third node.                                 |
|   | 04: Destination node busy           | ---                                     | The destination node is busy.   | Increase the number of retries or review the system so that the destination node does not receive so many messages.     |   |
|   | 05: Response timeout                | ---                                     | The message was destroyed by noise.   | Increase the number of retries or test communications between nodes to see if there is too much noise.                  |   |
|   |                                     |   | Instruction control data  | The response monitor time is too short.   | Increase the length of the response monitor time.                         |
|   |                                     |   | Error history   | The send/receive frame was discarded.   | Take appropriate measures based on the error history.                     |
|   |                                     |   | Destination node's FINS settings  | FINS is disabled in the FINS settings for the destination node.   | Check that FINS is enabled in the FINS settings for the destination node. |
| Destination node's packet filter settings |                                     |   | FINS is not permitted in the packet filter settings for the destination node. | Check that FINS is permitted in the packet filter settings for the destination node.                                    |   |
| 03: Controller error                      | 01: Communications controller error | Unit/Board indicators                   | An error occurred in the communications controller.                           | Take appropriate measures based on the operation manuals for the related Units/Boards.                                  |   |
|   | 02: CPU Unit error                  | CPU Unit indicators at destination node | A CPU error occurred in the destination CPU Unit.                             | Clear the error from the CPU Unit based on its operation manuals.   |   |
|   | 03: Controller error                | Board indicators                        | A response was not returned because an error occurred in the Board.           | Check network communications status and restart the Board. If the problem persists, replace the Board.                  |   |
|   | 04: Unit number error               | Unit number                             | The unit number was set incorrectly.  | Set the rotary switches correctly, being sure the unit numbers are within range and that each number is used only once. |   |
| 04: Service unsupported                   | 01: Undefined command               | Command code                            | The Unit/Board does not support the specified command code.                   | Check the command code.   |   |
|   | 02: Not supported by model/version  | Unit model and version                  | The command cannot be executed because the model or version is incorrect.     | Check the model number and version.   |   |

| <b>Main code</b>         | <b>Sub-code</b>                       | <b>Check point</b>    | <b>Probable cause</b>   | <b>Correction</b>   |
|--------------------------|---------------------------------------|-----------------------|---|---|
| 05: Routing table error  | 01: Destination address setting error | Routing table         | The destination network or node address is not set in the routing tables.                           | Register the destination network and node in the routing tables.  |
|                          | 02: No routing tables                 | Routing table         | Relaying is not possible because there are no routing tables.                                       | Set routing tables in the source node, designation node, and relay nodes.   |
|                          | 03: Routing table error               | Routing table         | There is an error in the routing tables.  | Set the routing tables correctly.   |
|                          | 04: Too many relays                   | Network configuration | An attempt was made to send to a network that was over 3 networks away                              | Reconstruct the networks or change the routing tables so that commands are sent within a range of 3 networks or less. |
| 10: Command format error | 01: Command too long                  | Command data          | The command is longer than the maximum permissible length.  | Check the command format and correct the command data.  |
|                          | 02: Command too short                 | Command data          | The command is shorter than the minimum permissible length.   | Check the command format and correct the command data.  |
|                          | 03: Elements/data don't match         | Command data          | The designated number of elements differs from the number of write data items.                      | Check the number of elements and set data for each element.   |
|                          | 04: Command format error              | Command data          | An incorrect format was used.   | Check the command format and correct the command data.  |
|                          | 05: Header error                      | Routing table         | Either the relay table in the local node or the local network table in the relay node is incorrect. | Set the routing tables correctly.   |

| Main code             | Sub-code                        | Check point   | Probable cause  | Correction  |
|-----------------------|---------------------------------|---|---|---|
| 11: Parameter error   | 01: Area classification missing | Memory area code in command data                        | The specified word does not exist in the memory area or there is no EM Area.  | Check the memory areas and parameter codes in the command and correct the command data. |
|                       | 02: Access size error           | Access size specification in command data               | The access size specification is incorrect or an odd word address is specified.   | Check the memory areas and access size and correct the access size.                     |
|                       | 03: Address range error         | Starting address in command data                        | The start address in command process is beyond the accessible area.   | Check the area being processed and set the correct range.                               |
|                       | 04: Address range exceeded      | Starting address and number of elements in command data | The end address in command process is beyond the accessible area.   | Check the area being processed and set the correct range.                               |
|                       |                                 |   | Data link tables  | The total number of words is beyond the limit.  |
|                       | 06: Program missing             | Program number in command data                          | FFFF hex was not specified.   | Specify FFFF hex.   |
|                       | 09: Relational error            | Command data  | A large–small relationship in the elements in the command data is incorrect.  | Check the command data and correct the relationship between the elements.               |
|                       |                                 | Data link table   | A node not set in the common link parameters is set as a refresh parameter.   | Correct the data link tables.   |
|                       | 0A: Duplicate data access       | I/O access in CPU Unit                                  | Differential monitoring was specified during data tracing or data tracing was specified during differential monitoring. | Abort the current process or wait until it ends before executing the command.           |
|                       |                                 | Data link tables  | The same node address is specified more than once.  | Correct the data link tables.   |
|                       | 0B: Response too long           | Number of elements in command data                      | The response format is longer than the maximum permissible length.  | Check the command format and correct the number of elements.                            |
|                       | 0C: Parameter error             | Parameters in command data                              | There is an error in one of the parameter settings.   | Check the command data and correct the parameters.                                      |
| Data link table file  |                                 | There is an error in the file.                          | Check the contents of the file.   |   |
| 20: Read not possible | 02: Protected                   | ---   | The program area is protected.  | Release protection from a Programming Device and then execute the command.              |
|                       | 03: Table missing               | Table   | A table has not been registered.  | Register a table.   |
|                       |                                 |   | There is an error in the table.   | Correct the table.  |
|                       | 04: Data missing                | ---   | The search data does not exist.   | ---   |
|                       | 05: Program missing             | Program number in command data                          | A non-existing program number has been specified.   | Check the program numbers and specify a valid one.                                      |
|                       | 06: File missing                | File name and file device                               | The file does not exist at the specified file device.   | Check the path and file name, and correct them.   |
|                       | 07: Data mismatch               | Contents of memory being compared                       | A data being compared is not the same.  | Check memory contents and use the correct data.   |
| ---                   |                                 |   | A file read operation failed.   | Check the contents of the file.   |

| Main code                           | Sub-code                                      | Check point  | Probable cause   | Correction  |
|-------------------------------------|---|--|--|---|
| 21: Write not possible              | 01: Read-only                                 | ---  | The specified area is read-only.   | If the area is protected using a switch setting, release protection and then execute the command. If the area is permanently read-only, the command cannot be executed. |
|                                     | 02: Protected<br>Cannot write data link table | ---  | The program area is protected.   | Release protection from a Programming Device and then execute the command.  |
|                                     |   | PLC Setup  | Writing is not possible because automatic data link table generation has been specified. | Change the PLC Setup so that the data link tables can be manually written.  |
|                                     | 03: Cannot register                           | Number of files in file device                                     | The file cannot be created because the limit has been exceeded.                          | Delete any unnecessary files or create more file memory.  |
|                                     |   | Number of files open   | The maximum number of files has already been opened for the system limit.                | Close one or more files and then execute the command.   |
|                                     | 05: Program missing                           | Program number in command data                                     | A non-existing program number has been specified.  | Check the program numbers and specify a valid one.  |
|                                     | 06: File missing                              | File name  | The file does not exist at the specified file device.                                    | Correct the file name and then execute the command.   |
|                                     | 07: File name already exists                  | File name  | A file with the same name already exists in the specified file device.                   | Change the name of the file being written and then execute the command.   |
| 08: Cannot change                   | Contents of memory being changed              | The change cannot be made because doing so would create a problem. | ---  |   |
| 22: Not executable in current mode  | 01: Not possible during execution             | ---  | The mode is incorrect.   | Check the mode.   |
|                                     |   | Data link status   | The data link is operating.  | Check the status of the data links.   |
|                                     | 02: Not possible while running                | ---  | The mode is incorrect.   | Check the mode.   |
|                                     |   | Data link status   | The data links are active.   | Check the status of the data links.   |
|                                     | 03: Wrong PLC mode                            | ---  | The PLC is in PROGRAM mode.  | Check the modes of the PLC and computer.  |
|                                     | 04: Wrong PLC mode                            | ---  | The PLC is in DEBUG mode.  | Check the modes of the PLC and computer.  |
|                                     | 05: Wrong PLC mode                            | ---  | The PLC is in MONITOR mode.  | Check the modes of the PLC and computer.  |
|                                     | 06: Wrong PLC mode                            | ---  | The PLC is in RUN mode.  | Check the modes of the PLC and computer.  |
| 07: Specified node not polling node | ---   | The specified node is not the polling node.                        | Check node functioning as the polling node for the network.                              |   |
| 08: Step cannot be executed         | ---   | The mode is incorrect.   | Check step status.   |   |
| 23: No such device                  | 01: File device missing                       | Unit configuration   | The specified memory does not exist as a file device.                                    | Mount memory or format EM as file memory.   |
|                                     | 02: Memory missing                            | ---  | There is no file memory.   | Check the file memory to see if it is mounted.  |
|                                     | 03: Clock missing                             | ---  | There is no clock.   | Check the model.  |
| 24: Cannot start/stop               | 01: Table missing                             | Data link tables   | The data link tables have not been registered or they contain an error.                  | Set the data link tables.   |

| <b>Main code</b>                  | <b>Sub-code</b>                | <b>Check point</b>   | <b>Probable cause</b>   | <b>Correction</b>   |
|-----------------------------------|--------------------------------|--|---|---|
| 25: Unit error                    | 02: Memory error               | Contents of memory being processed                         | The contents of memory contains an error.   | Transfer the correct contents to memory.  |
|                                   | 03: I/O setting error          | I/O Unit configuration                                     | The registered I/O tables do not agree with the actual I/O configuration.         | Correct the I/O tables or the I/O configuration.  |
|                                   | 04: Too many I/O points        | Number of I/O in registered I/O tables                     | There are too many I/O points and remote I/O points registered.                   | Change the registered I/O table so that it is within the limit.   |
|                                   | 05: CPU bus error              | CPU bus line   | An error occurred in data transfer between the CPU and a CPU Bus Unit.            | Check Units, Boards, and cables to be sure they are connected correctly and then execute the ERROR CLEAR command.   |
|                                   | 06: I/O duplication            | Rack numbers, Unit numbers, and I/O addresses in PLC Setup | The same number/address was set more than once.                                   | Check the PLC Setup and correct the numbers/addresses so that each is used only once.   |
|                                   | 07: I/O bus error              | I/O bus line   | An error occurred in data transfer between the CPU and an I/O Unit.               | Check Units, Boards, and cables to be sure they are connected correctly and then execute the ERROR CLEAR command.   |
|                                   | 09: SYSMAC BUS/2 error         | SYSMAC BUS/2 transmission path                             | An error occurred in data transfer on the SYSMAC BUS/2 line.                      | Check Units, Boards, and cables to be sure they are connected correctly and then execute the ERROR CLEAR command.   |
|                                   | 0A: CPU Bus Unit error         | CPU Bus Unit transmission path                             | An error occurred in data transfer for a CPU Bus Unit.                            | Check Units, Boards, and cables to be sure they are connected correctly and then execute the ERROR CLEAR command.   |
|                                   | 0D: SYSMAC BUS No. duplication | Word settings  | The same word is allocated more than once.  | Check the I/O tables and correct the allocations.   |
|                                   | 0F: Memory error               | Status of memory being processed                           | A memory error has occurred in internal memory, a memory card, or EM file memory. | For internal memory, write the correct data and then execute the command.<br><br>For a memory card or EM file memory, the file data has been destroyed. Execute the FILE MEMORY FORMAT command.<br><br>If the problem persists, replace the memory. |
| 10: SYSMAC BUS terminator missing | ---                            | Terminators have not been set.                             | Set the terminators correctly.  |   |

| Main code                | Sub-code                      | Check point  | Probable cause  | Correction  |
|--------------------------|-------------------------------|--|---|---|
| 26: Command error        | 01: No protection             | Command protection for program area                              | The specified area is not protected.  | An attempt was made to clear protection on an area that is not protected, i.e., there is no reason to clear protection.   |
|                          | 02: Incorrect password        | ---  | An incorrect password has been specified.   | Specify the correct password.   |
|                          | 04: Protected                 | ---  | The specified area is protected.  | Clear protection from a Programming Device and then execute the command.  |
|                          |                               | Number of commands being executed                                | The node receiving the command is already processing 5 commands.  | Wait for current processing to end or force the end of a current process and then execute the command.  |
|                          | 05: Service already executing | ---  | The service is being executed.  | Wait for the service to end or force the end of the service and then execute the command.   |
|                          | 06: Service stopped           | ---  | The service is not being executed.  | If necessary, start the service.  |
|                          | 07: No execution right        | LNK indicator on Unit/Board                                      | The right to execute the service has not been obtained.   | The local node is not in the data link. Execute the command from a node that is participating in the data link.   |
|                          |                               | ---  | A response was not returned because a buffer error occurred.  | Restart the Board. If the problem persists, replace the Board.  |
|                          | 08: Settings not complete     | Settings required before execution                               | The settings required before executing the service have not been made.  | Make the required settings.   |
|                          | 09: Necessary items not set   | Command data   | The required elements have not been set in the command data.  | Check the command format and set the required elements in the command data.   |
|                          | 0A: Number already defined    | Action numbers and transition numbers of program in program area | The specified action/ transition number has already been registered in a previous program.  | Check the action/transition numbers to ones that are not being used and then execute the command.   |
| 0B: Error will not clear | Cause of error being cleared  | The cause of the error has not been removed.                     | Remove the cause of the error and then execute ERROR CLEAR.   |   |
| 30: Access right error   | 01: No access right           | ---  | The access right is held by another device. (Online editing is being executed from another node or ACCESS RIGHT ACQUIRE or ACCESS RIGHT FORCE ACQUIRE has been executed by another node.) | Wait until the access right is released and then execute the command.<br><br>ACCESS RIGHT ACQUIRE or ACCESS RIGHT FORCE ACQUIRE can be executed to obtain the access right, but this may adversely affect processing by the node that previously held the access right. |
| 40: Abort                | 01: Service aborted           | ---  | Service was aborted with ABORT command.   | ---   |

In addition to the above end codes, there are also specific flags in the end code word (bits 6, 7, and 15) that may also be ON. If bit 6 or 7 is ON, an error has occurred in the destination CPU Unit. If bit 15 is ON, an error has occurred during a network relay operation. The contents of the end code word are shown in the following diagram.

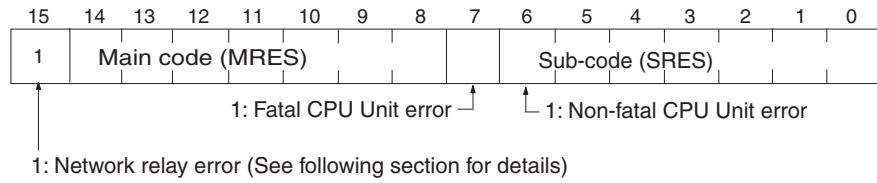

**Handling Fatal and Non-fatal CPU Errors**

If bit 6 or 7 is ON, an error has occurred in the destination CPU Unit. If this occurs, refer to the operation manuals for the CPU Unit where the error occurred and remove the cause of the error.

**Example of a CPU Unit Error**

For example, if a battery error occurs in the destination CPU Unit, bit 6 in the end code will be ON, because a battery error is a non-fatal CPU Unit error. Basically, the end code of a sent command that is completed normally is 0040.

**Handling Network Relay Errors**

If bit 15 is ON, an error has occurred during a network relay operation. The end code has an additional two-byte (one word) network relay error code, which can be used to determine the location of the relay error. The following diagram shows the response data when a network relay error occurs when CMND(490) is used.

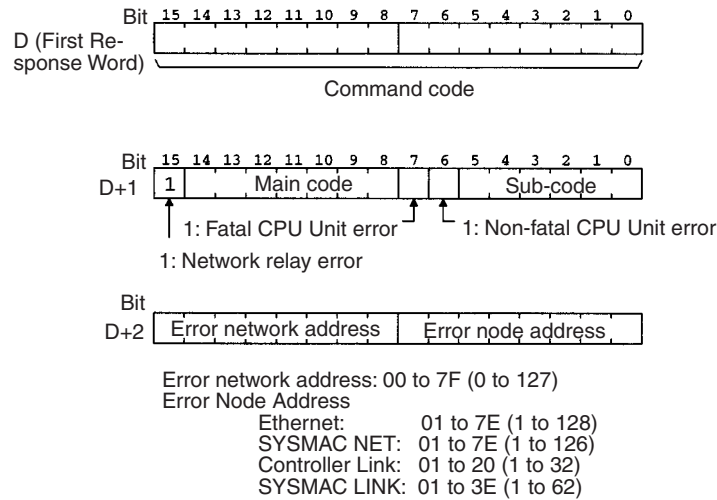

Use this information to determine the node where the error occurred and take appropriate measures.

**Note** When Using SEND(090) and RECV(098)

Check the path the command took using the routing tables. Check the end code and take appropriate measures for the relay node where the error occurred.



## 5-2 Designating Command Parameters

### 5-2-1 Designating I/O Memory (Variable) Area Addresses

When reading from and writing to the I/O memory (variable) area, designate I/O memory area addresses as described below.

I/O memory designation involves the designation of the memory area code and the address within the memory area code.

- Memory area codes are designated in one byte (two digits hexadecimal), as shown in the table in 5-2-2 I/O Memory Address Designations.
- Addresses within memory area codes consist of a total of three bytes (six digits hexadecimal). Of these, two bytes (four digits hexadecimal) designate the word and one byte (two digits hexadecimal) designates the bit.

| I/O memory address designation                 |   | Memory area code  | Address within I/O memory area designation               |  |
|--|---|---|--|--|
|  |   |   | Word   | Bit  |
| 4 bytes (8 digits hexadecimal)                 | ⇒ | 1 byte (2 digits hex)   | 2 bytes (4 digits hex)                                   | 1 byte (2 digits hex)  |
| Memory area code + word + bit, in order        |   | Set by classification (CIO, WR, etc.).<br>Note: Also possible with forced status. | From 0000 hex (Upper limit depends on memory area code.) | 00 to 0F hex<br>Note: Always 00 hex for word address and Timer/Counter Completion Flags. |
| Example<br>Bit 13 of CIO 0010:<br>30000A0D hex |   | Example<br>CIO: 30 hex  | Example<br>0010: 000A in hexadecimal                     | Example<br>Bit 13: 0D in hexadecimal   |

Example: I/O memory reading  
Bit 13 of CIO 0010, i.e., CIO 001013, is read.

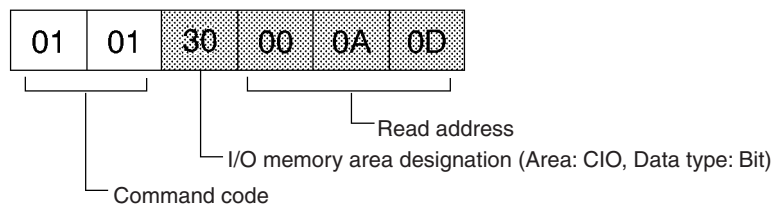

Example: Reading W005

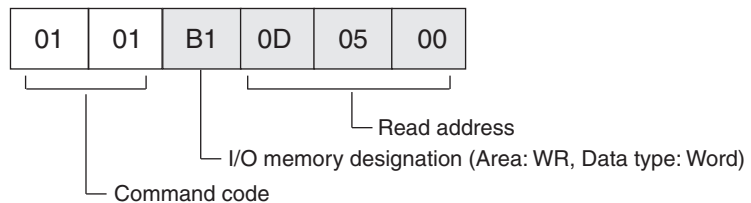

#### Element Data Configurations

#### Bit Designations

When bits are designated, each bit is considered a single element. The data for the element is expressed in one byte (ON: 01 hex; OFF: 00 hex). When data is written, this byte is transmitted. When data is read, this byte is returned.

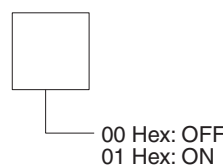

**Bit Data with Forced Status**

When bits are designated, each bit is considered as one element.

The data for each element is expressed in one byte (8 bits). Bit 00 indicates the specified bit data, and bit 01 indicates the forced status. When reading, this one byte is returned.

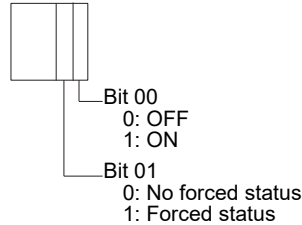

**Word Designations**

When words are designated, each word is considered a single element. The data for the element is expressed in two bytes. Bits 0 to 15 correspond to bits 0 to 15 of each word. When data is written, these two bytes are transmitted for each word. When data is read, these two bytes are returned.

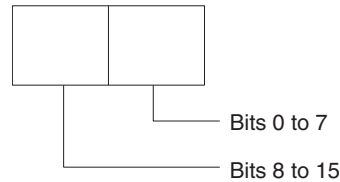

**Word Data With Forced Status Data, Present Value (4 Bytes)**

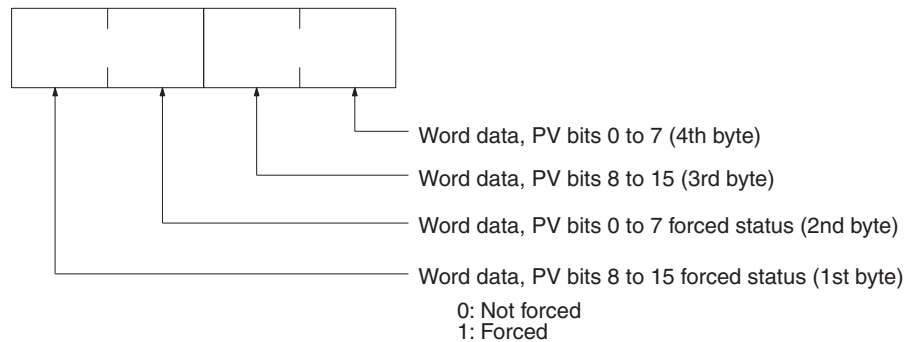

**Current EM Bank Number (2 Bytes)**

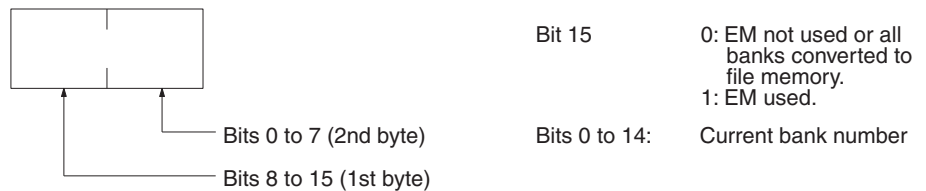

## 5-2-2 I/O Memory Address Designations

| Area               |     | Data type                     | CS/CJ/CP/NSJ-series    |                              |                               | CVM1/CV-series         |                                 |                                     | Length per element |
|--------------------|-----|-------------------------------|------------------------|------------------------------|-------------------------------|------------------------|---------------------------------|-------------------------------------|--------------------|
|                    |     |                               | Memory area code (hex) | Memory area address          | Memory address                | Memory area code (hex) | Memory area address             | Memory address                      |                    |
| CIO Area           | CIO | Bit                           | 30                     | CIO 000000 to CIO 614315     | 000000 to 17FF0F              | 00                     | CIO 000000 to CIO 255515        | 000000 to 09FB0F                    | 1                  |
| Work Area          | WR  |                               | 31                     | W00000 to W51115             | 000000 to 01FF0F              | ---                    | ---                             | ---                                 |                    |
| Holding Bit Area   | HR  |                               | 32                     | H00000 to H51115             | 000000 to 01FF0F              | ---                    | ---                             | ---                                 |                    |
| Auxiliary Bit Area | AR  |                               | 33                     | A00000 to A44715 (read only) | 000000 to 01BF0F              | 00                     | A00000 to A44715 (read only)    | 0B0000 to 0CBF0F                    |                    |
|                    |     | A44800 to A95915 (read/write) |                        | 01C000 to 03BF0F             | A44800 to A95915 (read/write) |                        | 0CC000 to 0EBF0F                |                                     |                    |
| CIO Area           | CIO | Bit with forced status        | 70                     | CIO 000000 to CIO 614315     | 000000 to 17FF0F              | 40                     | CIO 000000 to CIO 255515        | 000000 to 09FB0F                    | 1                  |
| Work Area          | WR  |                               | 71                     | W00000 to W51115             | 000000 to 01FF0F              | ---                    | ---                             | ---                                 |                    |
| Holding Bit Area   | HR  |                               | 72                     | H00000 to H51115             | 000000 to 01FF0F              | ---                    | ---                             | ---                                 |                    |
| CIO Area           | CIO | Word                          | B0                     | CIO 0000 to CIO 6143         | 000000 to 17FF00              | 80                     | CIO 0000 to CIO 2555            | 000000 to 09FB00                    | 2                  |
| Work Area          | WR  |                               | B1                     | W000 to W511                 | 000000 to 01FF00              | ---                    | ---                             | ---                                 |                    |
| Holding Bit Area   | HR  |                               | B2                     | H000 to H511                 | 000000 to 01FF00              | ---                    | ---                             | ---                                 |                    |
| Auxiliary Bit Area | AR  |                               | B3                     | A000 to A447 (read only)     | 000000 to 01BF00              | 80                     | A000 to A447 (read only)        | 0B0000 to 0CBF00                    |                    |
|                    |     | A448 to A959 (read/write)     |                        | 01C000 to 03BF00             | A448 to A959 (read/write)     |                        | 0CC000 to 0EBF00                |                                     |                    |
| CIO Area           | CIO | Word with forced status       | F0                     | CIO 0000 to CIO 6143         | 000000 to 17FF00              | C0                     | CIO 000000 to CIO 255515        | 000000 to 09FB00                    | 4                  |
| Work Area          | WR  |                               | F1                     | W000 to W511                 | 000000 to 01FF00              | ---                    | ---                             | ---                                 |                    |
| Holding Bit Area   | HR  |                               | F2                     | H000 to H511                 | 000000 to 01FF00              | ---                    | ---                             | ---                                 |                    |
| Timer Area         | TIM | Completion Flag               | 09                     | T0000 to T4095               | 000000 to 0FFF00              | 01                     | T0000 to T2047 (T0000 to T1023) | 000000 to 07FF00 (000000 to 03FF00) | 1                  |
| Counter Area       | CNT |                               |                        | C0000 to C4095               | 800000 to 8FFF00              |                        | C0000 to C2047 (C0000 to C1023) | 080000 to 0FFF00 (080000 to 0BFF00) |                    |

| Area         |                       | Data type                          | CS/CJ/CP/NSJ-series               |   |                  | CVM1/CV-series         |  |                                     | Length per element |
|--------------|-----------------------|------------------------------------|-----------------------------------|---|------------------|------------------------|--|-------------------------------------|--------------------|
|              |                       |                                    | Memory area code (hex)            | Memory area address                               | Memory address   | Memory area code (hex) | Memory area address                    | Memory address                      |                    |
| Timer Area   | TIM                   | Completion Flag with forced status | 49                                | T0000 to T4095                                    | 000000 to 0FFF00 | 41                     | T0000 to T2047 (T0000 to T1023)        | 000000 to 07FF00 (000000 to 03FF00) | 1                  |
| Counter Area | CNT                   |                                    |                                   | C0000 to C4095                                    | 800000 to 8FFF00 |                        | C0000 to C2047 (C0000 to C1023)        | 080000 to 0FFF00 (080000 to 0BFF00) |                    |
| Timer Area   | TIM                   | PV                                 | 89                                | T0000 to T4095                                    | 000000 to 0FFF00 | 81                     | T0000 to T2047 (T0000 to T1023)        | 000000 to 07FF00 (000000 to 03FF00) | 2                  |
| Counter Area | CNT                   |                                    |                                   | C0000 to C4095                                    | 800000 to 8FFF00 |                        | C0000 to C2047 (C0000 to C1023)        | 080000 to 0FFF00 (080000 to 0BFF00) |                    |
| DM Area      | DM                    | Bit                                | 02                                | D0000000 to D3276715                              | 000000 to 7FFF0F | ---                    | ---                                    | ---                                 | 1                  |
|              | DM                    | Word                               | 82                                | D00000 to D32767                                  | 000000 to 7FFF00 | 82                     | D00000 to D32767                       | 000000 to 7FFF00                    | 2                  |
| EM Area      | EM bank 0 to bank F   | Bit                                | 20 to 2F (See note 2)             | E0_0000000 to 3276715 to EF_0000000 to 3276715    | 000000 to 7FFF0F | ---                    | ---                                    | ---                                 | 1                  |
|              | EM bank 10 to bank 18 |                                    | E0 to E8 (See note 2)             | E10_0000000 to 3276715 to E18_00000000 to 3276715 | 000000 to 7FFF0F | ---                    | ---                                    | ---                                 | 1                  |
|              | EM bank 0 to bank F   | Word                               | A0 to AF or 50 to 5F (See note 2) | E0_00000 to 32767 to EF_00000 to 32767            | 000000 to 7FFF00 | 90 to 97               | E0_00000 to 32767 to E7_00000 to 32767 | 000000 to 7FFF00                    | 2                  |
|              | EM bank 10 to bank 18 |                                    | 60 to 68 (See note 2)             | E10_00000 to 32767 to E18_00000 to 32767          | 000000 to 7FFF00 | ---                    | ---                                    | ---                                 | 2                  |
|              | EM current bank       | Bit                                | 0A (See note 3)                   | E0000000 to E3276715                              | 000000 to 7FFF0F | ---                    | ---                                    | ---                                 | 1                  |
|              |                       | Word                               | 98                                | E00000 to E32767                                  | 000000 to 7FFF00 | 98                     | E000000 to E32767                      | 000000 to 7FFF00                    | 2                  |
|              | EM current bank No.   | Bank No.                           | BC                                | ---   | 0F0000           | 9C                     | ---                                    | 000600                              | 2                  |
| Task Flag    | TK                    | Bit                                | 06                                | TK0000 to TK0031                                  | 000000 to 001F00 | ---                    | ---                                    | ---                                 | 1                  |
|              | TK                    | Status                             | 46                                | TK0000 to TK0031                                  | 000000 to 001F00 | ---                    | ---                                    | ---                                 | 1                  |

| Area            |    | Data type         | CS/CJ/CP/NSJ-series    |                                  |                  | CVM1/CV-series         |                     |                  | Length per element |
|-----------------|----|-------------------|------------------------|----------------------------------|------------------|------------------------|---------------------|------------------|--------------------|
|                 |    |                   | Memory area code (hex) | Memory area address              | Memory address   | Memory area code (hex) | Memory area address | Memory address   |                    |
| Index Register  | IR | PV                | DC                     | IR00 to IR15                     | 010000 to 010F00 | ---                    | ---                 | ---              | 4                  |
| Data Register   | DR | PV                | BC                     | DR00 to DR15                     | 020000 to 020F00 | 9C                     | DR0 to DR2          | 000300 to 000500 | 2                  |
| Clock Pulses    |    | Bit               | 07                     | 1-min clock pulse                | 000000           | ---                    | ---                 | ---              | 1                  |
|                 |    |                   |                        | 1-s clock pulse                  | 000100           |                        |                     |                  |                    |
|                 |    |                   |                        | 0.2-s clock pulse                | 000200           |                        |                     |                  |                    |
|                 |    |                   |                        | 0.1-s clock pulse                | 000300           |                        |                     |                  |                    |
|                 |    |                   |                        | 0.02-s clock pulse               | 000400           |                        |                     |                  |                    |
| Condition Flags |    | Bit               |                        | Error Flag (ER)                  | 100000           | ---                    | ---                 | ---              | 1                  |
|                 |    |                   |                        | Carry Flag (CY)                  | 100100           |                        |                     |                  |                    |
|                 |    |                   |                        | Greater Than Flag (>)            | 100200           |                        |                     |                  |                    |
|                 |    |                   |                        | Equals Flag (=)                  | 100300           |                        |                     |                  |                    |
|                 |    |                   |                        | Less Than Flag (<)               | 100400           |                        |                     |                  |                    |
|                 |    |                   |                        | Negative Flag (N)                | 100500           |                        |                     |                  |                    |
|                 |    |                   |                        | Overflow Flag (OF)               | 100600           |                        |                     |                  |                    |
|                 |    |                   |                        | Underflow Flag (UF)              | 100700           |                        |                     |                  |                    |
|                 |    |                   |                        | Greater Than or Equals Flag (>=) | 100800           |                        |                     |                  |                    |
|                 |    |                   |                        | Not Equal Flag (<>)              | 100900           |                        |                     |                  |                    |
|                 |    |                   |                        | Less Than or Equals Flag (<=)    | 100A00           |                        |                     |                  |                    |
|                 |    |                   |                        | Always OFF Flag (ON)             | 100E00           |                        |                     |                  |                    |
|                 |    |                   |                        | Always ON Flag (OFF)             | 100F00           |                        |                     |                  |                    |
|                 |    | Access Error Flag | 200100                 | ---                              | ---              | 1                      |                     |                  |                    |

- Note**
1. The only current EM bank that can be read with FINS commands is the current EM bank that is set at the end of the cycle.
  2. 2D to 2F/E0 to E8, AD to AF/60 to 68 can be specified in the I/O memory type of EM banks D to F/10 to 18 in the CJ2 and the CS1D-CPU68HA only. 50 to 5F can be specified in the I/O memory type of EM banks 0 to F in the CJ2 and the CS1D-CPU68HA only.
  3. Only with the CJ2 CPU Unit, bit addresses of EM current bank (I/O memory type 0A) can be specified.

**Examples**

| Example   | Designation   | Contents         |                                 |        |
|---|---------------|------------------|---------------------------------|--------|
|   |               | Memory area code | Address within memory area code |        |
|   |               |                  | Word                            | Bit    |
| CIO 0010  | B0000A00 hex  | B0 hex           | 000A hex                        | 00 hex |
| CIO 001013<br>(bit 13 of CIO 0010)                  | 30000A0D hex  | 30 hex           | 000A hex                        | 0D hex |
| W010  | B10000A00 hex | B1 hex           | 000A hex                        | 00 hex |
| W01013<br>(bit 13 of W010)                          | 31000A0D hex  | 31 hex           | 000A hex                        | 0D hex |
| H010  | B2000A00 hex  | B2 hex           | 000A hex                        | 00 hex |
| H01013<br>(bit 13 of H010)                          | 32000A0D hex  | 32 hex           | 000A hex                        | 0D hex |
| CIO 001013 (bit 13 of CIO 0010), with forced status | 70000A0D hex  | 70 hex           | 000A hex                        | 0D hex |
| CIO 0010, with forced status                        | F0000A00 hex  | F0 hex           | 000A hex                        | 00 hex |
| T0010 Completion Flag                               | 09000A00 hex  | 09 hex           | 000A hex                        | 00 hex |
| D00010 value  | 82000A00 hex  | 82 hex           | 000A hex                        | 00 hex |
| E_3_00010 value                                     | A3000A00 hex  | A3 hex           | 000A hex                        | 00 hex |
| Current EM bank 00010 value                         | 98000A00 hex  | 98 hex           | 000A hex                        | 00 hex |

**Number of Elements for I/O MEMORY AREA READ (0101) and I/O MEMORY AREA WRITE (0102)**

The maximum number of elements that can be specified for reading or writing with I/O MEMORY AREA READ (0101) and I/O MEMORY AREA WRITE (0102) depends on the network that must be passed through.

| Network         | Max. number of read elements | Max. number of write elements |
|-----------------|------------------------------|-------------------------------|
| SYSWAY          | 269 words                    | 267 words                     |
| Ethernet        | 999 words                    | 997 words                     |
| Controller Link | 999 words                    | 997 words                     |
| SYSMAC LINK     | 269 words                    | 267 words                     |
| DeviceNet       | 269 words                    | 267 words                     |

If more than one network is passed through to read or write data, the value for the network with the smallest limit will apply.

**Volume Labels and File Names**

Volume labels are names registered in file memory. File names consist of 12 bytes, as shown below. Be sure to follow this configuration when designating a file name by means of command parameters.

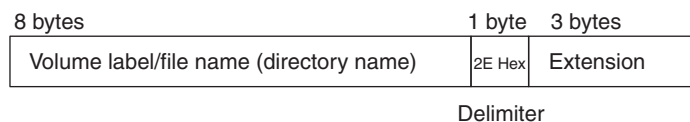

Start the file name and extension in the most-significant bytes respectively and then fill in any unused bytes with 20 hex.

If the file name or extension in response data is less than 8 or 3 bytes respectively, unused bytes will be filled with 20 hex.

It is not permissible to specify 00 (hex) or E5 (hex) at the beginning of a file name. (Codes of 00 hex or E5 hex means "erased" in DOS.) It is also not per-

missible to specify 7E hex (-) at the first and second characters (consecutive) of a file name.

If a file name has no extension, fill both the period (2E hex) and the extension with 20 hex.

If the file name in response data has no extension, both the period (2E hex) and the extension will be filled with 20 hex.

## 5-3 FINS Commands

### 5-3-1 About this Section

This section describes the command and response formats for FINS commands. For each format, the data is arranged in order from left to right.

#### Command and Response Formats

##### Using CMND(490)

When CMND(490) is used to send a FINS command, the command is stored in I/O memory from the rightmost word to the leftmost word, with a single word represented as two boxes (four digits hexadecimal) in the format diagram.

In the following example, five words of data are written from D00010.

##### Command Format

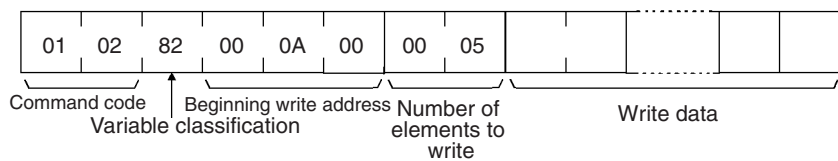

The command format data is stored in the order shown below when CMND(490) is used.

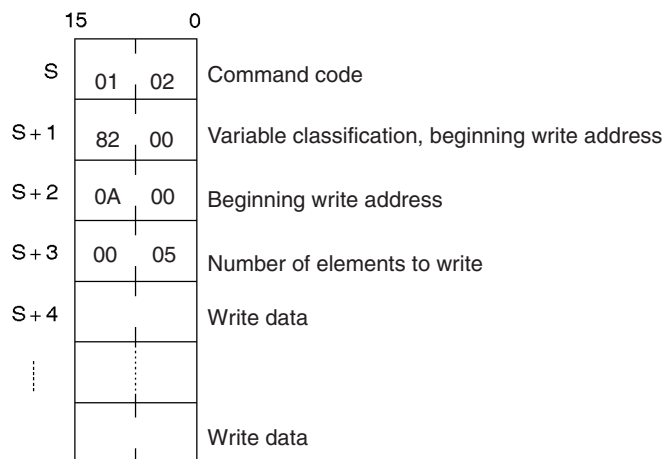

##### Response Format

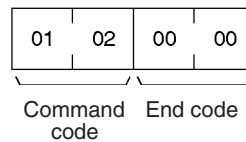

The response format data is stored in the order shown below when CMND(490) is used.

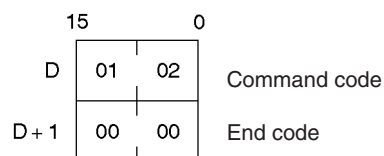



**Using Host Link Communications**

When a FINS command is sent using Host Link communications, the Host Link header, response wait time, destination node address, and source node address are all placed before the command format, and the frame check sequence (FCS) and terminator are placed after the command format before sending the command from the host computer.

**Execution Conditions**

The *Execution Conditions* tables given for each command tell whether the CPU Unit can or cannot receive commands when it is in RUN, MONITOR, or PROGRAM mode, when another device has the access right, when command protection is in effect, and when the DIP switch is protected.

**Access Right at Other Device**

The *Access right at other device* column tells whether the CPU Unit can or cannot receive a command when another device has the access right to the CPU Unit.

**Note** The access right is the exclusive right of access to a particular device (the CPU Unit in this case) which prevents interruption by another device (i.e., another Peripheral Device or Unit) when multiple commands are executed. When another device has the access right, the local device cannot execute commands marked by a “No” in the “Access right at other device” column. Conversely, other devices cannot execute this command when the local device has the access right.

**UM Read Protection**

The *UM read protection* column tells whether the CPU Unit can or cannot receive the command when UM (user memory) is protected from a Peripheral Device.

**DIP Switch UM write Protection**

The *DIP switch UM protection* column tells whether the CPU Unit can or cannot receive a command when UM is write-protected by turning ON pin 1 of the DIP switch on the CPU Unit’s front panel.

**Network Write Protection**

The *Validate FINS Write Protection via Network* parameter in the PLC Setup can be used to set whether the CPU Unit will accept or reject network commands.

**5-3-2 MEMORY AREA READ: 01 01**

Reads the contents of the specified number of consecutive memory area words starting from the specified word.

**Execution Conditions**

| Access right at other device | UM read protection | DIP switch UM write protection | Network write protection |
|------------------------------|--------------------|--------------------------------|--------------------------|
| OK                           | OK                 | OK                             | OK                       |

  

| RUN mode | MONITOR mode | PROGRAM mode |
|----------|--------------|--------------|
| OK       | OK           | OK           |

**Command Format**

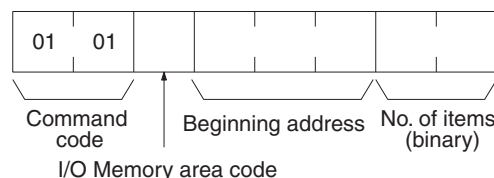

**Response Format**

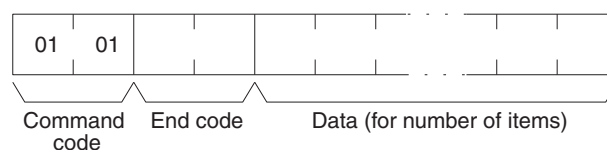

**Parameters****I/O memory area code, beginning address, number of items (command)**

Specify the type of data read, the beginning address of the data to be read, and the number of items of data to be read (4 digits hexadecimal).

The memory areas that can be read are given in the following table (*I/O Memory Area Codes*). Refer to 5-2-2 I/O Memory Address Designations for the specific addresses that can be used.

**Data (response)**

Indicates the data from the specified I/O memory area is returned in sequence starting from the beginning address. The required number of bytes in total is calculated as follows:

Number of bytes required by each item x number of items

For details regarding data configuration, refer to *Element Data Configurations* on page 163.

**End code (response)**

Refer to 5-1-3 End Codes for information on end codes.

- Note**
1. If the specified number of elements is 0000 hex, nothing will be read and a normal response will be returned.
  2. I/O memory can be read regardless of the operating mode of the CPU Unit.

I/O Memory Area Codes

| Area                |                       | Data type       | CS/CJ/CP/<br>NSJ-series<br>memory area<br>code (hex) | CVM1/CV-<br>series<br>memory area<br>code (hex) | Bytes per<br>element |   |
|---------------------|-----------------------|-----------------|--|---|----------------------|---|
| CIO Area            | CIO                   | Bit             | 30   | 00  | 1                    |   |
| Work Area           | WR                    |                 | 31   | ---   |                      |   |
| Holding Bit Area    | HR                    |                 | 32   | ---   |                      |   |
| Auxiliary Bit Area  | AR                    |                 | 33   | 00  |                      |   |
| CIO Area            | CIO                   | Word            | B0   | 80  | 2                    |   |
| Work Area           | WR                    |                 | B1   | ---   |                      |   |
| Holding Bit Area    | HR                    |                 | B2   | ---   |                      |   |
| Auxiliary Bit Area  | AR                    |                 | B3   | 80  |                      |   |
| Timer Area          | TIM                   | Completion Flag | 09   | 01  | 1                    |   |
| Counter Area        | CNT                   |                 |  |   |                      |   |
| Timer Area          | TIM                   | PV              | 89   | 81  | 2                    |   |
| Counter Area        | CNT                   |                 |  |   |                      |   |
| DM Area             | DM                    | Bit             | 02   | ---   | 1                    |   |
|                     | DM                    | Word            | 82   | 82  | 2                    |   |
| EM Area             | EM bank 0 to bank F   | Bit             | 20 to 2F<br>(see note 1)                             | ---   | 1                    |   |
|                     | EM bank 10 to bank 18 |                 | E0 to E8<br>(see note 1)                             | ---   | 1                    |   |
|                     | EM bank 0 to bank F   | Word            | A0 to AF or<br>50 to 5F<br>(see note 1)              | 90 to 97  | 2                    |   |
|                     | EM bank 10 to bank 18 |                 | 60 to 68<br>(see note 1)                             | ---   | 2                    |   |
|                     | EM current bank       |                 | Bit  | 0A<br>(see note 2)                              | ---                  | 1 |
|                     |                       |                 | Word   | 98  | 98                   | 2 |
| EM current bank No. | Bank No.              | BC              | 9C   | 2   |                      |   |
| Task Flag           | TK                    | Bit             | 06   | ---   | 1                    |   |
|                     | TK                    | Status          | 46   | ---   | 1                    |   |
| Index Register      | IR                    | PV              | DC   | ---   | 4                    |   |
| Data Register       | DR                    | PV              | BC   | 9C  | 2                    |   |
| Clock Pulses        |                       | Bit             | 07   | ---   | 1                    |   |
| Condition Flags     |                       | Bit             |  |   | 1                    |   |

- Note**
- 2D to 2F/E0 to E8, AD to AF/60 to 68 can be specified in the I/O memory type of EM banks D to F/10 to 18 in the CJ2 and the CS1D-CPU68HA only. 50 to 5F can be specified in the I/O memory type of EM banks 0 to F in the CJ2 and the CS1D-CPU68HA only.
  - Only with the CJ2 CPU Unit, bit addresses of EM current bank (I/O memory type 0A) can be specified.

### 5-3-3 MEMORY AREA WRITE: 01 02

Writes data to the specified number of consecutive words starting from the specified word.

**Execution Conditions**

|                                     |                           |                                       |                                 |
|-------------------------------------|---------------------------|---------------------------------------|---------------------------------|
| <b>Access right at other device</b> | <b>UM read protection</b> | <b>DIP switch UM write protection</b> | <b>Network write protection</b> |
| OK                                  | OK                        | OK                                    | No                              |

|                 |                     |                     |
|-----------------|---------------------|---------------------|
| <b>RUN mode</b> | <b>MONITOR mode</b> | <b>PROGRAM mode</b> |
| OK              | OK                  | OK                  |

**Command Format**

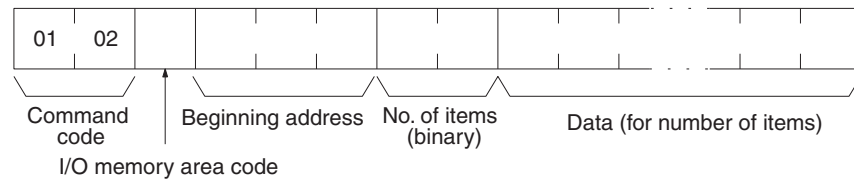

**Response Format**

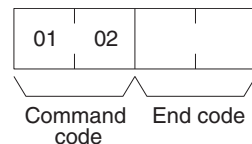

**Parameters**

**I/O memory area code, beginning address, number of items (command)**  
 Specify the type of data written, the beginning address of the data to be written, and the number of items of data to be written (4 digits hexadecimal).  
 The memory areas that can be written are given in the following table (*I/O Memory Area Codes*). Refer to 5-2-2 I/O Memory Address Designations for the specific addresses that can be used.

**Data (command)**

The data from the specified I/O memory area is returned in sequence starting from the beginning address. The required number of bytes in total is calculated as follows:

$$\text{Number of bytes required by each item} \times \text{number of items}$$

For details regarding data configuration, refer to *Element Data Configurations* on page 163.

**End code (response)**

Refer to 5-1-3 End Codes for information on end codes.

**Comments**

If the number of items is designated as 0000 (hex), a normal completion end code will be returned without the write operation being executed.

The MEMORY AREA WRITE command can be executed regardless of the CPU Unit's operating mode. It is the user's responsibility to program steps to prohibit this command from being executed when the CPU Unit is in RUN mode if such protection is necessary. Execute CPU UNIT STATUS READ (command code 0601) to read the CPU Unit's mode. (Refer to 5-3-17 CPU UNIT STATUS READ: 06 01.)

When data is written to the Timer/Counter PV Area, the Completion Flags will not be turned OFF (0).

I/O Memory Area Codes

| Area               |                       | Data type | CS/CJ/CP/<br>NSJ-series<br>memory area<br>code (hex) | CVM1/CV-<br>series<br>memory area<br>code (hex) | Bytes per<br>element |
|--------------------|-----------------------|-----------|--|---|----------------------|
| CIO Area           | CIO                   | Bit       | 30   | ---   | 1                    |
| Work Area          | WR                    |           | 31   | ---   |                      |
| Holding Bit Area   | HR                    |           | 32   | ---   |                      |
| Auxiliary Bit Area | AR                    |           | 33   | ---   |                      |
| CIO Area           | CIO                   | Word      | B0   | 80  | 2                    |
| Work Area          | WR                    |           | B1   | ---   |                      |
| Holding Bit Area   | HR                    |           | B2   | ---   |                      |
| Auxiliary Bit Area | AR                    |           | B3   | 80  |                      |
| Timer Area         | TIM                   | PV        | 89   | 81  | 2                    |
| Counter Area       | CNT                   |           |  |   |                      |
| DM Area            | DM                    | Bit       | 02   | ---   | 1                    |
|                    | DM                    | Word      | 82   | 82  | 2                    |
| EM Area            | EM bank 0 to bank F   | Bit       | 20 to 2F<br>(see note 1)                             | ---   | 1                    |
|                    | EM bank 10 to bank 18 |           | E0 to E8<br>(see note 1)                             | ---   | 1                    |
|                    | EM bank 0 to bank F   | Word      | A0 to AF or<br>50 to 5F<br>(see note 1)              | 90 to 97  | 2                    |
|                    | EM bank 10 to bank 18 |           | 60 to 68<br>(see note 1)                             | ---   | 2                    |
|                    | EM current bank       | Bit       | 0A<br>(see note 2)                                   | ---   | 1                    |
|                    | Word                  | 98        | 98   | 2   |                      |
| Index Register     | IR                    | PV        | DC   | ---   | 4                    |
| Data Register      | DR                    | PV        | BC   | 9C  | 2                    |

- Note**
- 2D to 2F/E0 to E8, AD to AF/60 to 68 can be specified in the I/O memory type of EM banks D to F/10 to 18 in the CJ2 and the CS1D-CPU68HA only. 50 to 5F can be specified in the I/O memory type of EM banks 0 to F in the CJ2 and the CS1D-CPU68HA only.
  - Only with the CJ2 CPU Unit, bit addresses of EM current bank (I/O memory type 0A) can be specified.

**5-3-4 MEMORY AREA FILL: 01 03**

Writes the same data to the specified number of consecutive memory area words.

**Execution Conditions**

| Access right at other device | UM read protection | DIP switch UM write protection | Network write protection |
|------------------------------|--------------------|--------------------------------|--------------------------|
| OK                           | OK                 | OK                             | No                       |

  

| RUN mode | MONITOR mode | PROGRAM mode |
|----------|--------------|--------------|
| OK       | OK           | OK           |

**Command Format**

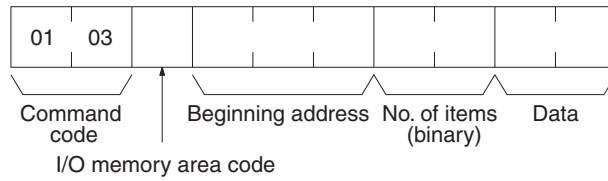

**Response Format**

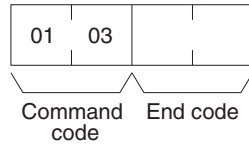

**Parameters**

**I/O memory area code, beginning address, number of items (command)**

Specify the type of data written, the beginning address of the data to be written, and the number of items of data to be written (4 digits hexadecimal). The memory areas that can be written are given in the following table (*I/O Memory Area Codes*). Refer to 5-2-2 I/O Memory Address Designations for the specific addresses that can be used.

**Data (command)**

Specify the data to be written to the memory area starting from the beginning address. The data to be written should consist of two bytes.

For details regarding data configuration, refer to *Element Data Configurations* on page 163.

**End code (response)**

Refer to 5-1-3 End Codes for information on end codes.

**Comments**

If the number of items is designated as 0000 (hex), a normal completion end code will be returned without the write operation being executed.

The MEMORY AREA FILL command can be executed regardless of the CPU Unit's operating mode. It is the user's responsibility to program steps to prohibit this command from being executed when the CPU Unit is in RUN mode if such protection is necessary. Execute CPU UNIT STATUS READ (command code 0601) to read the CPU Unit's mode. (Refer to 5-3-17 CPU UNIT STATUS READ: 06 01.)

When data is written to the Timer/Counter PV Area, the Completion Flags will be turned OFF (0).

Data cannot be written if the address is out of range.

If the specified area is force set or reset, clear the force set/reset to write the data.

**I/O Memory Area Codes**

| Area               |     | Data type | CS/CJ/CP/<br>NSJ-series<br>memory area<br>code (hex) | CVM1/CV-<br>series<br>memory area<br>code (hex) | Bytes per<br>element |
|--------------------|-----|-----------|--|---|----------------------|
| CIO Area           | CIO | Word      | B0   | 80  | 2                    |
| Work Area          | WR  |           | B1   | ---   |                      |
| Holding Bit Area   | HR  |           | B2   | ---   |                      |
| Auxiliary Bit Area | AR  |           | B3   | 80  |                      |
| Timer Area         | TIM | PV        | 89   | 81  | 2                    |
| Counter Area       | CNT |           |  |   |                      |
| DM Area            | DM  | Word      | 82   | 82  | 2                    |

|         |                       |      |                                  |          |   |
|---------|-----------------------|------|----------------------------------|----------|---|
| EM Area | EM bank 0 to bank F   | Word | A0 to AF (see note.) or 50 to 5F | 90 to 97 | 2 |
|         | EM bank 10 to bank 18 |      | 60 to 68 (see note.)             | ---      | 2 |
|         | EM current bank       | Word | 98                               | 98       | 2 |

**Note** AD to AF/60 to 68 can be specified in the I/O memory type of EM banks D to F/10 to 18 in the CJ2 and the CS1D-CPU68HA only.  
 50 to 5F can be specified in the I/O memory type of EM banks 0 to F in the CJ2 and the CS1D-CPU68HA only.

### 5-3-5 MULTIPLE MEMORY AREA READ: 01 04

Reads in one batch the contents of the specified number of non-consecutive I/O memory area words, starting from the specified word.

#### Execution Conditions

| Access right at other device | UM read protection | DIP switch UM write protection | Network write protection |
|------------------------------|--------------------|--------------------------------|--------------------------|
| OK                           | OK                 | OK                             | OK                       |

| RUN mode | MONITOR mode | PROGRAM mode |
|----------|--------------|--------------|
| OK       | OK           | OK           |

#### Command Format

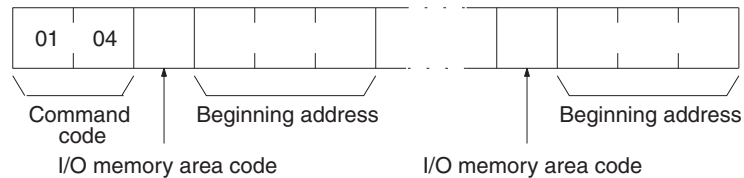

#### Response Format

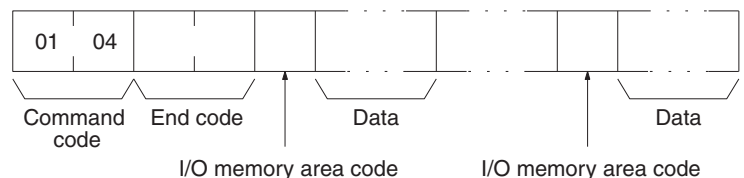

#### Parameters

##### **I/O memory area code (command)**

Specify the type of data to read.

The memory areas that can be read are given in the following table (*I/O Memory Area Codes*). Refer to 5-2-2 I/O Memory Address Designations for the specific addresses that can be used.

##### **Beginning address (command)**

Specify the first word/bit/flag to read.

##### **I/O memory area code, data (response)**

Indicates the data type and contents of the designated I/O memory area(s). The data in the designated memory area(s) will be returned in the sequence specified by the command.

The number of bytes that can be read for each item depends on the I/O memory area that is read. For details regarding data configuration, refer to *Element Data Configurations* on page 163.

**End code (response)**

Refer to 5-1-3 End Codes for information on end codes.

**Comments**

The maximum number of elements that can be read with each command depends on the network as shown in the following table.

| Network                  | Maximum number of elements |
|--------------------------|----------------------------|
| Controller Link Ethernet | 167                        |
| SYSMAC LINK DeviceNet    | 89                         |

If nothing is specified after the command code, a normal response will be returned, but nothing will be read.

If there is an error in the I/O memory area code or beginning address, the I/O memory area will not be read.

**I/O Memory Area Codes**

| Area               |     | Data type                          | CS/CJ/CP/<br>NSJ-series<br>memory area<br>code (hex) | CVM1/CV-<br>series<br>memory area<br>code (hex) | Bytes per<br>element |
|--------------------|-----|------------------------------------|--|---|----------------------|
| CIO Area           | CIO | Bit                                | 30   | 00  | 1                    |
| Work Area          | WR  |                                    | 31   | ---   |                      |
| Holding Bit Area   | HR  |                                    | 32   | ---   |                      |
| Auxiliary Bit Area | AR  |                                    | 33   | 00  |                      |
| CIO Area           | CIO | Bit with forced status             | 70   | 40  | 1                    |
| Work Area          | WR  |                                    | 71   | ---   |                      |
| Holding Bit Area   | HR  |                                    | 72   | ---   |                      |
| CIO Area           | CIO | Word                               | B0   | 80  | 2                    |
| Work Area          | WR  |                                    | B1   | ---   |                      |
| Holding Bit Area   | HR  |                                    | B2   | ---   |                      |
| Auxiliary Bit Area | AR  |                                    | B3   | 80  |                      |
| CIO Area           | CIO | Word with forced status            | F0   | C0  | 4                    |
| Work Area          | WR  |                                    | F1   | ---   |                      |
| Holding Bit Area   | HR  |                                    | F2   | ---   |                      |
| Timer Area         | TIM | Completion Flag                    | 09   | 01  | 1                    |
| Counter Area       | CNT |                                    |  |   |                      |
| Timer Area         | TIM | Completion Flag with forced status | 49   | 41  | 1                    |
| Counter Area       | CNT |                                    |  |   |                      |
| Timer Area         | TIM | PV                                 | 89   | 81  | 2                    |
| Counter Area       | CNT |                                    |  |   |                      |
| DM Area            | DM  | Bit                                | 02   | ---   | 1                    |
|                    | DM  | Word                               | 82   | 82  | 2                    |



| Area                   |                          | Data type                   | CS/CJ/CP/<br>NSJ-series<br>memory area<br>code (hex) | CVM1/CV-<br>series<br>memory area<br>code (hex) | Bytes per<br>element |   |
|------------------------|--------------------------|-----------------------------|--|---|----------------------|---|
| EM Area                | EM bank 0 to<br>bank F   | Bit with forced sta-<br>tus | 20 to 2C<br>(see note 1)                             | ---   | 1                    |   |
|                        | EM bank 10 to<br>bank 18 |                             | E0 to E8<br>(see note 1)                             | ---   | 1                    |   |
|                        | EM bank 0 to<br>bank F   | Word                        | A0 to AF or<br>50 to 5F<br>(see note 1)              | 90 to 97  | 2                    |   |
|                        | EM bank 10 to<br>bank 18 |                             | 60 to 68<br>(see note 1)                             | ---   | 2                    |   |
|                        | EM current<br>bank       |                             | Bit  | 0A<br>(see note 2)                              | ---                  | 1 |
|                        |                          |                             | Word   | 98  | 98                   | 2 |
| EM current<br>bank No. | EM current bank<br>No.   |                             | BC   | 9C  | 2                    |   |
| Task Flag              | TK                       | Bit                         | 06   | ---   | 1                    |   |
|                        | TK                       | Status                      | 46   | ---   | 1                    |   |
| Index Register         | IR                       | PV                          | DC   | ---   | 4                    |   |
| Data Register          | DR                       | PV                          | BC   | 9C  | 2                    |   |
| Clock Pulses           |                          | Bit                         | 07   | ---   | 1                    |   |
| Condition Flags        |                          | Bit                         |  |   | 1                    |   |

- Note**
- 2D to 2F/E0 to E8, AD to AF/60 to 68 can be specified in the I/O memory type of EM banks D to F/10 to 18 in the CJ2 and the CS1D-CPU68HA only. 50 to 5F can be specified in the I/O memory type of EM banks 0 to F in the CJ2 and the CS1D-CPU68HA only.
  - Only with the CJ2 CPU Unit, bit addresses of EM current bank (I/O memory type 0A) can be specified.

### 5-3-6 MEMORY AREA TRANSFER: 01 05

Copies and transfers the contents of the specified number of consecutive I/O memory area words to the specified I/O memory area.

**Execution Conditions**

|                                     |                           |                                       |                                 |
|-------------------------------------|---------------------------|---------------------------------------|---------------------------------|
| <b>Access right at other device</b> | <b>UM read protection</b> | <b>DIP switch UM write protection</b> | <b>Network write protection</b> |
| OK                                  | OK                        | OK                                    | No                              |

|                 |                     |                     |
|-----------------|---------------------|---------------------|
| <b>RUN mode</b> | <b>MONITOR mode</b> | <b>PROGRAM mode</b> |
| OK              | OK                  | OK                  |

**Command Format**

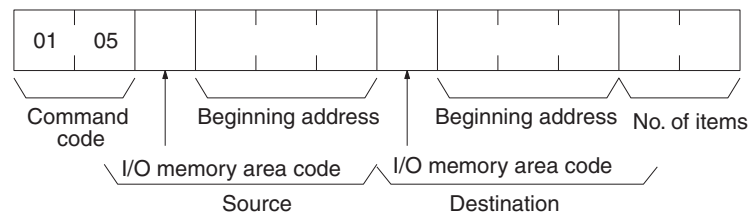

**Response Format**

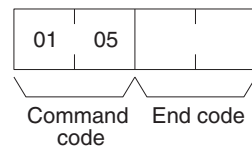

**Parameters**

**I/O memory area code and Beginning address (command)**

Specify the data area to transfer from and the data area to transfer to and specify the positions for beginning the data transfer.

The memory areas that can be transferred are given in the following table (*I/O Memory Area Codes*). Refer to 5-2-2 I/O Memory Address Designations for the specific addresses that can be used.

**Number of items (command)**

Specify the number of words of data to transfer. (Each word consists of two bytes.) The specified number of words will be transferred in sequence from the source beginning address onwards to the destination beginning address onwards.

**End code (response)**

Refer to 5-1-3 End Codes for information on end codes.

**Comments**

If the number of items is designated as 0000 (hex), a normal completion end code will be returned without the copy operation being executed.

It is the user's responsibility to program steps to prohibit this command from being executed when the CPU Unit is in RUN mode if such protection is necessary. Execute CPU UNIT STATUS READ (command code 0601) to read the CPU Unit's mode. (Refer to 5-3-17 CPU UNIT STATUS READ: 06 01.)

Even if data is written to the Timer/Counter PV Area, the Completion Flags will not be turned OFF (0).

I/O Memory Area Codes

| Area               |                       | Data type | CS/CJ/CP/NSJ-series memory area code (hex) | CVM1/CV-series memory area code (hex) | Bytes per element |
|--------------------|-----------------------|-----------|--|---------------------------------------|-------------------|
| CIO Area           | CIO                   | Word      | B0   | 80                                    | 2                 |
| Work Area          | WR                    |           | B1   | ---                                   |                   |
| Holding Bit Area   | HR                    |           | B2   | ---                                   |                   |
| Auxiliary Bit Area | AR                    |           | B3   | 80                                    |                   |
| Timer Area         | TIM                   | PV        | 89   | 81                                    | 2                 |
| Counter Area       | CNT                   |           |  |                                       |                   |
| DM Area            | DM                    | Word      | 82   | 82                                    | 2                 |
| EM Area            | EM bank 0 to bank F   | Word      | A0 to AF (see note.)<br>or<br>50 to 5F     | 90 to 97                              | 2                 |
|                    | EM bank 10 to bank 18 |           | 60 to 68 (see note.)                       | ---                                   |                   |
|                    | EM current bank       | Word      | 98   | 98                                    | 2                 |

**Note** AD to AF/60 to 68 can be specified in the I/O memory type of EM banks D to F/10 to 18 in the CJ2 and the CS1D-CPU68HA only.  
50 to 5F can be specified in the I/O memory type of EM banks 0 to F in the CJ2 and the CS1D-CPU68HA only.

5-3-7 PARAMETER AREA READ: 02 01

Reads the contents of the specified number of consecutive CPU Unit parameter area words starting from the specified word.

Execution Conditions

| Access right at other device | UM read protection | DIP switch UM write protection | Network write protection |
|------------------------------|--------------------|--------------------------------|--------------------------|
| OK                           | OK                 | OK                             | OK                       |

  

| RUN mode | MONITOR mode | PROGRAM mode |
|----------|--------------|--------------|
| OK       | OK           | OK           |

Command Format

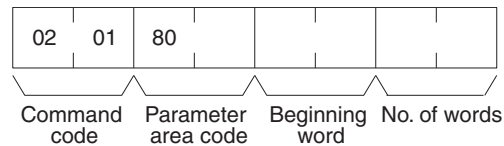

Response Format

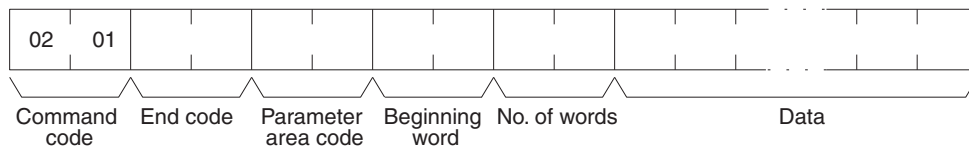

Parameters

**Parameter area code (command and response)**

Specify the parameter area to read. The parameter area code is designated in two bytes. The leftmost byte is always 80 (hex) and the rightmost byte specifies the parameter area.

**Beginning word (command and response)**

Specify the first word to read. The beginning word address specifies the relative word address, with the beginning of the designated area as 0000 (hex).

**Parameter Areas**

The areas that can be read are shown below, along with their parameter area codes.

|                             | Parameter area code | Address range (Hex)        | Parameter area code | Address range (Hex)       |
|-----------------------------|---------------------|----------------------------|---------------------|---------------------------|
| PLC Setup Area              | 8010                | 0000 to 01FF (512 words)   | 8000                | 0000 to 1F3F (8000 words) |
| I/O Table Registration Area | 8012                | 0000 to 04FF (1,280 words) |                     |                           |
| Routing Table Area          | 8013                | 0000 to 01FF (512 words)   |                     |                           |
| CPU Bus Unit Setup Area     | 8002                | 0000 to 143F (5184 words)  |                     |                           |

**Number of words (command and response)**

Bits 0 to 14 are used to specify the number of words to be read. (Each word consists of 16 bits.) Bit 15 must be OFF (0) in the command format. When the content in the response format contains the last word of data in the specified parameter area, bit 15 will be ON (1). For example, it would indicate that the 512th word of data is contained in the PLC Setup area.

**Data (response)**

The data in the specified parameter area will be returned in sequence starting from the beginning word. The leftmost bits (bits 8 to 15) of each word are read first, followed by the rightmost bits (bits 0 to 7). The required number of bytes in total for each read is calculated as follows:

$$\text{Number of words} \times 2 \text{ (each word consists of 16 bits)}$$

**End code (response)**

Refer to 5-1-3 End Codes for information on end codes.

**Comments**

All words in the specified parameter area must be read at the same time to ensure complete data. A maximum of 498 words can be read with each command. (One word = 16 bits.) To read larger parameter areas, use multiple commands and specify the beginning word and number of words for each.

If more than 498 words is specified as the number of elements, the maximum number of words will be read and returned with a response code of 1108 hex.

If the beginning word plus the number of words specified to read exceeds the capacity of the specified area, the data read through the end of the area and the actual number of words read will be returned with a response of 1104 hex.

Except for the routing table area, each area must be read or written in its entirety.

**5-3-8 PARAMETER AREA WRITE: 02 02**

Writes data to the specified number of consecutive CPU Unit parameter area words starting from the specified word.

Data can be written to the I/O table only when the CPU Unit is in PROGRAM mode.

**Note** Some PLC Setup parameters cannot be written in RUN or MONITOR mode.

**Execution Conditions**

| Access right at other device | UM read protection | DIP switch UM write protection | Network write protection |
|------------------------------|--------------------|--------------------------------|--------------------------|
| No                           | OK                 | No                             | No                       |

|                 |                     |                     |
|-----------------|---------------------|---------------------|
| <b>RUN mode</b> | <b>MONITOR mode</b> | <b>PROGRAM mode</b> |
| OK              | OK                  | OK                  |

**Command Format**

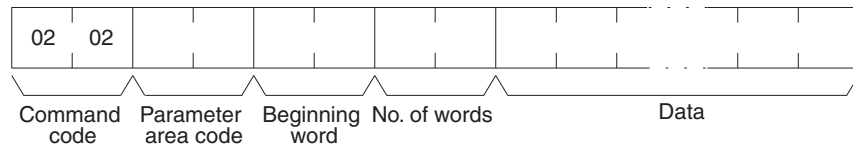

**Response Format**

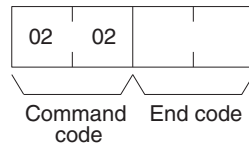

**Parameters**

**Parameter area code (command and response)**

Specify the parameter area to write. The parameter area code is designated in two bytes. The leftmost byte is always 80 (hex) and the rightmost byte specifies the parameter area.

**Beginning word (command and response)**

Specify the first word to write. The beginning word address specifies the relative word address, with the beginning of the designated area as 0000 (hex).

**Parameter Areas**

The areas that can be written to are shown below, along with their parameter area codes.

|                             | Parameter area code | Address range (Hex)        | Parameter area code | Address range (Hex)       |
|-----------------------------|---------------------|----------------------------|---------------------|---------------------------|
| PLC Setup Area              | 8010                | 0000 to 01FF (512 words)   | 8000                | 0000 to 1F3F (8000 words) |
| I/O Table Registration Area | 8012                | 0000 to 04FF (1,280 words) |                     |                           |
| Routing Table Area          | 8013                | 0000 to 01FF (512 words)   |                     |                           |
| CPU Bus Unit Setup Area     | 8002                | 0000 to 143F (5184 words)  |                     |                           |

**Number of words (command)**

Bits 0 to 14 are used to specify the number of words to be written. (Each word consists of two bytes.) Bit 15 must be ON (1) when data is written to the last word in the specified parameter area or no data will be written. If the number of write words is set to 0000, no words will be written and a normal end code will be returned.

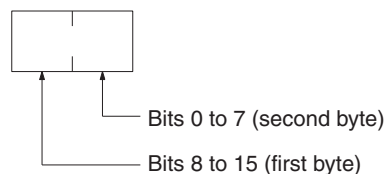

Bit 15 OFF (0): Without last word data to be written.  
 Bit 15 ON (1): With last word data to be written.  
 Bits 0 to 14: No. of words to be written

**Data (command)**

The data to be written. The leftmost bits (bits 15 to 8) of each word must be specified first, followed by the rightmost bits (bits 7 to 0). The required number of bytes in total for each write can be calculated as follows:

$$\text{No. of words} \times 2 \text{ (each word consists of two bytes)}$$

**End code (response)**

Refer to 5-1-3 End Codes for information on end codes.

**Comments**

Parameters will be written regardless of the operating mode of the CPU Unit. There are some settings in the PLC Setup that cannot and will not be written if the CPU Unit is in RUN mode, but the end code will be 0000 nevertheless. It is the user's responsibility to program steps to prohibit this command from being executed when the CPU Unit is in the RUN mode if such protection is necessary. Execute CPU UNIT STATUS READ (command code 0601) to read the CPU Unit's mode. (Refer to 5-3-17 CPU UNIT STATUS READ: 06 01.)

Data can only be written to the I/O registration table when the CPU Unit is in PROGRAM mode.

All words in the specified parameter area must be written at the same time to ensure complete data. A maximum of 498 words can be written with each command. Nothing will be written if more than 498 words are specified. To write larger parameter areas, use multiple commands and specify the beginning word for each.

Except for the routing table area, each area must be read or written in its entirety.

**5-3-9 PARAMETER AREA CLEAR: 02 03**

Writes all zeros to the specified number of consecutive parameter area words to clear the previous data. The I/O table can be cleared only when the CPU Unit is in PROGRAM mode.

**Note** Some PLC Setup parameters cannot be written in RUN or MONITOR mode.

**Execution Conditions**

|                                     |                           |                                       |                                 |
|-------------------------------------|---------------------------|---------------------------------------|---------------------------------|
| <b>Access right at other device</b> | <b>UM read protection</b> | <b>DIP switch UM write protection</b> | <b>Network write protection</b> |
| No                                  | OK                        | No                                    | No                              |

  

|                 |                     |                     |
|-----------------|---------------------|---------------------|
| <b>RUN mode</b> | <b>MONITOR mode</b> | <b>PROGRAM mode</b> |
| OK              | OK                  | OK                  |

**Command Format**

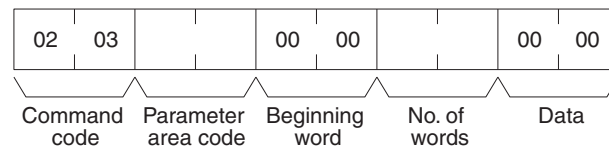

**Response Format**

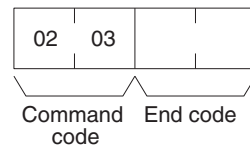

**Parameters**

**Parameter area code (command)**

Specify the parameter area to clear.

**Beginning word (command)**

Always 0000.

**Number of words (command)**

Specify the number of words to clear. (One word = 16 bits.) If the number of write words is set to 0000, no words will be written and a normal end code will be returned.

**Parameter Areas**

The areas that can be written to are shown below, along with their parameter area codes.

|                             | Parameter area code | Address range (Hex)        | Parameter area code | Address range (Hex)       |
|-----------------------------|---------------------|----------------------------|---------------------|---------------------------|
| PLC Setup Area              | 8010                | 0000 to 01FF (512 words)   | 8000                | 0000 to 1F3F (8000 words) |
| I/O Table Registration Area | 8012                | 0000 to 04FF (1,280 words) |                     |                           |
| Routing Table Area          | 8013                | 0000 to 01FF (512 words)   |                     |                           |
| CPU Bus Unit Setup Area     | 8002                | 0000 to 143F (5184 words)  |                     |                           |

**Data (command)**

Set to 0000. The number of words to be cleared is specified by the number of words in the command format. This parameter has two bytes (one word) of data.

**End code (response)**

Refer to 5-1-3 End Codes for information on end codes.

**Comments**

The PARAMETER AREA CLEAR command can be executed regardless of the CPU Unit's mode. It is the user's responsibility to program steps to prohibit this command from being executed when the CPU Unit is in the RUN mode if such protection is necessary. Execute CPU UNIT STATUS READ (command code 0601) to read the CPU Unit's mode. (Refer to 5-3-17 CPU UNIT STATUS READ: 06 01.)

Data can only be cleared from the I/O registration table when the CPU Unit is in PROGRAM mode. When data is cleared from the I/O registration table for CJ-series CPU Units, the CPU Unit enters the status where I/O is automatically allocated at power-ON and the status of mounted Units is reflected in the I/O registration table. It is not simply cleared to 0000 hex.

Each parameter area must be cleared in its entirety.

**5-3-10 PROGRAM AREA READ: 03 06**

Reads the contents of the specified number of consecutive program area words starting from the specified word.

**Execution Conditions**

| Access right at other device | UM read protection | DIP switch UM write protection | Network write protection |
|------------------------------|--------------------|--------------------------------|--------------------------|
| OK                           | No                 | OK                             | OK                       |

| RUN mode | MONITOR mode | PROGRAM mode |
|----------|--------------|--------------|
| OK       | OK           | OK           |

**Command Format**

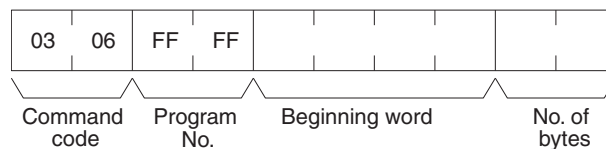

**Response Format**

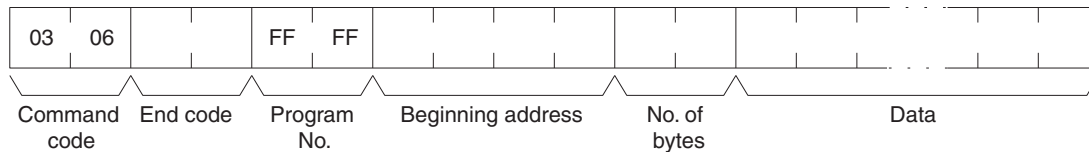

**Parameters**

**Program No. (command and response)**

Set to FFFF (hex).

**Beginning address (command and response)**

For the beginning address, the beginning of the program area is specified as a relative address of 00000000 (hex). The beginning address must be a multiple of four.

**Number of bytes (command and response)**

The number of bytes must be a multiple of four, and no greater than 992. The leftmost bit (bit 15) indicates whether the data at the last address in the program area is included. If bit 15 is ON (1) when the response is returned, it indicates that the data at the last address in the program area is included in the read data. Bit 15 must be OFF (0) in the command format.

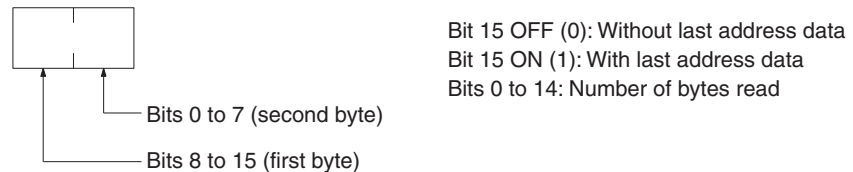

**Data (response)**

The data in the specified program area will be returned in sequence starting from the beginning word.

**End code (response)**

Refer to 5-1-3 End Codes for information on end codes.

**Comments**

A maximum of 992 bytes can be read with each command. Partition the data into units of 992 bytes or less and use as many commands as necessary to read from 00000000 (hex) to the final address.

When the "Prohibit from saving into a memory card, and transferring program from PLC" setting is enabled, this command cannot be executed.

**5-3-11 PROGRAM AREA WRITE: 03 07**

Writes data to the specified number of consecutive program area words starting from the specified word.

**Execution Conditions**

|                                     |                           |                                       |                                 |
|-------------------------------------|---------------------------|---------------------------------------|---------------------------------|
| <b>Access right at other device</b> | <b>UM read protection</b> | <b>DIP switch UM write protection</b> | <b>Network write protection</b> |
| No                                  | OK                        | No                                    | No                              |

|                 |                     |                     |
|-----------------|---------------------|---------------------|
| <b>RUN mode</b> | <b>MONITOR mode</b> | <b>PROGRAM mode</b> |
| No              | No                  | OK                  |



**Command Format**

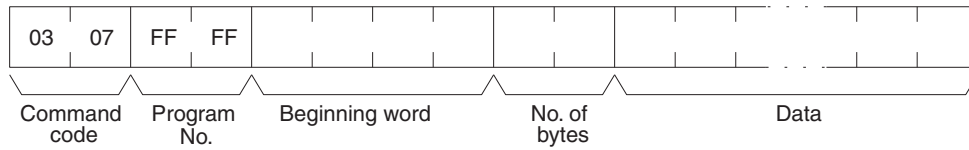

**Response Format**

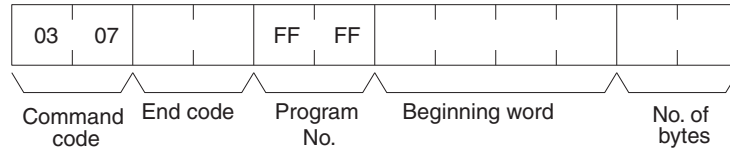

**Parameters**

**Program No. (command and response)**

Always FFFF (hex).

**Beginning word (command and response)**

For the beginning address, the beginning of the program area is specified as a relative address of 00000000 (hex). The beginning address must be a multiple of four.

**Number of bytes (command and response)**

Specify the number of bytes of data to write. The number of bytes must be a multiple of 4 and 996 or less. The leftmost bit (bit 15) is used to indicate when program area writing is completed. Bit 15 must be ON (1) the last word of data.

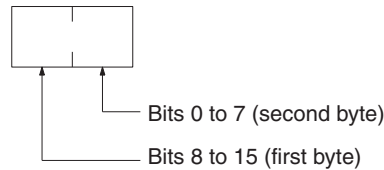

Bit 15 OFF (0): Not last word of data  
 Bit 15 ON (1): Last word of data  
 Bits 0 to 14: Number of bytes written

**Data (command)**

Specify the data to be written by designating the beginning address and the number of bytes.

**End code (response)**

Refer to 5-1-3 End Codes for information on end codes.

**Comments**

The PROGRAM AREA WRITE command can be executed only when the CPU Unit is in PROGRAM mode.

A maximum of 996 bytes can be written with each command. Partition the data into units of 996 bytes or less and use as many commands as necessary to write from 00000000 (hex) to the final address.

When the "Prohibit from overwriting to a protected program" setting is enabled, this command cannot be executed.

**5-3-12 PROGRAM AREA CLEAR: 03 08**

Completely initializes the contents of the program area, from the beginning of the program area to the final program address.

**Execution Conditions**

| Access right at other device | UM read protection | DIP switch UM write protection | Network write protection |
|------------------------------|--------------------|--------------------------------|--------------------------|
| No                           | OK                 | No                             | No                       |

| RUN mode | MONITOR mode | PROGRAM mode |
|----------|--------------|--------------|
| No       | No           | OK           |

**Command Format**

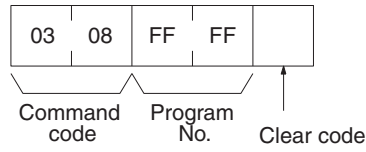

**Response Format**

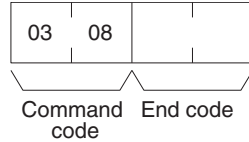

**Parameters**

**Program No. (command)**

Set to FFFF (hex).

**Clear code (command)**

Without interrupt tasks: 00 (hex)

With interrupt tasks: 10 (hex)

**End code (response)**

Refer to 5-1-3 End Codes for information on end codes.

**Comments**

The program area can be cleared even if it is read-protected from a Programming Device. When the program area is cleared, protection will also be cleared.

**Without Interrupt Tasks**

In this mode, only one single cyclic task 0 is set up.

| Name                     | Number | Task No. |
|--------------------------|--------|----------|
| Power interrupt task     | 0      | ---      |
| Scheduled interrupt task | 0      | ---      |
| I/O interrupt task       | 0      | ---      |
| Cyclic task              | 1      | 0        |

**With Interrupt Tasks**

In this mode, one single cyclic task 0 and one or several interrupt tasks are set up.

| Name                     | Number | Task No. |
|--------------------------|--------|----------|
| Power interrupt task     | 1      | 1        |
| Scheduled interrupt task | 2      | 2        |
|                          |        | 3        |
| I/O interrupt task       | 32     | 100      |
|                          |        | .        |
|                          |        | 131      |
| Cyclic task              | 1      | 0        |

**Note** Interrupt tasks and cyclic tasks contain only one END(001) instruction after execution.

When the "Prohibit from overwriting to a protected program" setting is enabled, this command cannot be executed.

### 5-3-13 RUN: 04 01

Changes the CPU Unit's operating mode to MONITOR or RUN, enabling the PLC to execute its program.

**Note** The CPU Unit will start operation when RUN is executed. You must confirm the safety of the system before executing RUN. When the "prohibit overwriting of protected program" setting is enabled, this command cannot be executed.

**Execution Conditions**

|                                     |                           |                                       |                                 |
|-------------------------------------|---------------------------|---------------------------------------|---------------------------------|
| <b>Access right at other device</b> | <b>UM read protection</b> | <b>DIP switch UM write protection</b> | <b>Network write protection</b> |
| No                                  | OK                        | OK                                    | No                              |

  

|                 |                     |                     |
|-----------------|---------------------|---------------------|
| <b>RUN mode</b> | <b>MONITOR mode</b> | <b>PROGRAM mode</b> |
| OK              | OK                  | OK                  |

**Command Format**

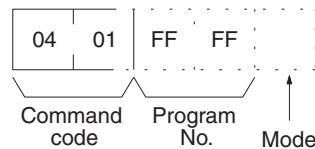

**Response Format**

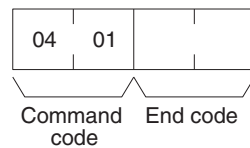

**Parameters**

**Program number (command)**

Always FFFF (hex).

**Mode (command)**

Set the CPU Unit's operating mode as follows:

- 02 (hex): Change to MONITOR mode.
- 04 (hex): Change to RUN mode.

**End code (response)**

Refer to 5-1-3 End Codes for information on end codes.

**Comments**

If only the command code or only the command code and program number are sent, the mode will be changed to MONITOR mode.

If the CPU Unit's operating mode has already been changed to the intended mode when this command is sent, a normal completion will be returned.

### 5-3-14 STOP: 04 02

Changes the CPU Unit's operating mode to PROGRAM, stopping program execution.

**Note** The CPU Unit will stop operation when STOP is executed. You must confirm the safety of the system before executing STOP.

Execution Conditions

|                              |                    |                                |                          |
|------------------------------|--------------------|--------------------------------|--------------------------|
| Access right at other device | UM read protection | DIP switch UM write protection | Network write protection |
| No                           | OK                 | OK                             | No                       |

  

|          |              |              |
|----------|--------------|--------------|
| RUN mode | MONITOR mode | PROGRAM mode |
| OK       | OK           | OK           |

Command Format

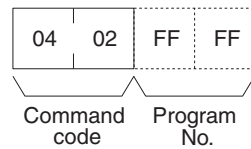

Response Format

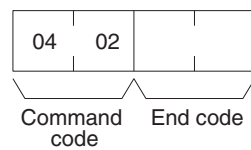

Parameters

**Program number (command)**

Always FFFF (hex).

**End code (response)**

Refer to 5-1-3 End Codes for information on end codes.

Comments

If the CPU Unit's operating mode has already been changed to the intended mode when this command is sent, a normal completion will be returned.  
 If only the command code or only the command code and program number are to be sent, the operating mode will be changed to the PROGRAM mode.

**5-3-15 CPU UNIT DATA READ: 05 01**

Reads the following data:

- CPU Unit model
- CPU Bus Unit configuration
- CPU Unit internal system version
- Remote I/O data
- Area data
- CPU Unit information

Execution Conditions

|                              |                    |                                |                          |
|------------------------------|--------------------|--------------------------------|--------------------------|
| Access right at other device | UM read protection | DIP switch UM write protection | Network write protection |
| OK                           | OK                 | OK                             | OK                       |

|          |              |              |
|----------|--------------|--------------|
| RUN mode | MONITOR mode | PROGRAM mode |
| OK       | OK           | OK           |

Command Format

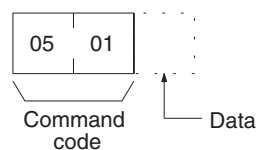

**Response Format**

The format is as shown below if 00 (hex) is specified as the data to be read, i.e., from the CPU Unit model to the area data.

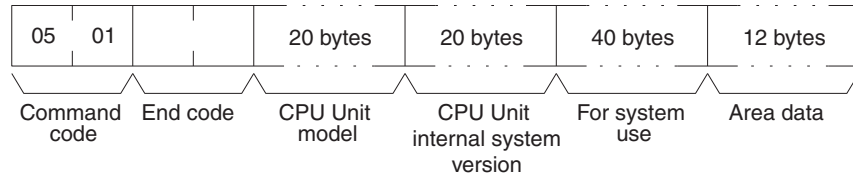

The format is as shown below if 01 (hex) is specified as the data to be read, i.e., from the CPU Bus Unit configuration to the CPU Unit information.

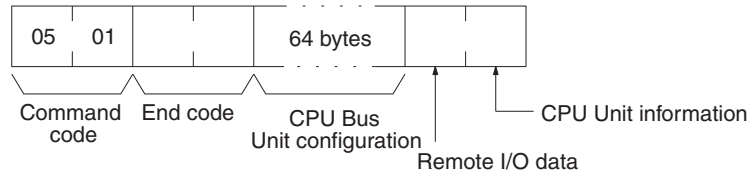

The format is as shown below if nothing is entered as the data to be read, i.e., all data from the CPU Unit model to the CPU Unit information.

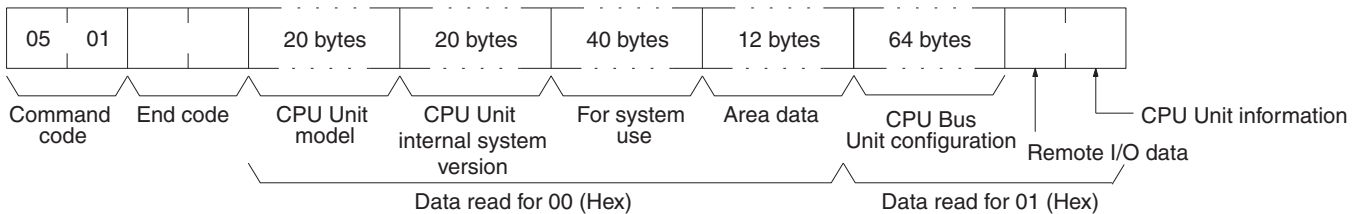

**Parameters**

**Data (command)**

Specify the data to be read as follows:

| Value           | 00  | 01  |
|-----------------|---|---|
| Data to be read | CPU Unit model<br>CPU Unit internal system version<br>Area data | CPU Bus Unit configuration<br>Remote I/O data<br>CPU Unit information |

**CPU Unit model and internal system version (response)**

Each is returned in not more than 20 bytes in ASCII (i.e. 20 ASCII characters). If the model or internal system version requires less than 20 characters, the model field will be filled with spaces and the internal system version field will be filled with null codes.

**For system use (response)**

Reserved for system use.

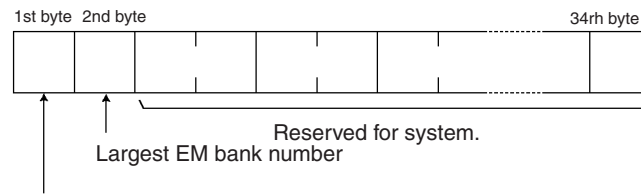

| Item                   | Meaning  | Unit |
|------------------------|--|------|
| DIP switch data        | Status of DIP switch on front panel of CPU Unit: Pins 0 to 7 correspond to bits 0 to 7 (ON: 1; OFF: 0) | ---  |
| Largest EM bank number | Largest number, 0 to 19, in CPU Unit's EM area.  | Bank |

**Area data (response)**

The area data is configured as follows:

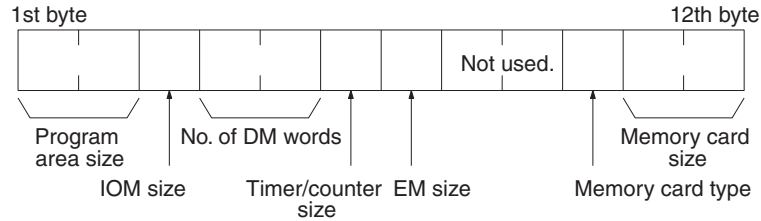

| Item                    | Meaning   | Unit                             |
|-------------------------|---|----------------------------------|
| Program area size       | Maximum size of usable program area   | K words (1K words = 1,024 words) |
| IOM size                | The size of the area (CIO, WR, HR, AR, timer/counter completion flags, TN) in which bit commands can be used (always 23). | K bytes (1K bytes = 1,024 bytes) |
| Number of DM words      | Total words in the DM area (always 32,768)  | Words                            |
| Timer/counter size      | Maximum number of timers/counters available (always 8)  | x 1,024                          |
| EM non-file memory size | Among the banks in the EM area, the number of banks (0 to D) without file memory.   | Banks (1 bank = 32,768 words)    |
| Memory card type        | 00: No memory card<br>04: Flash memory  | ---                              |
| Memory card size        | Size of the memory card (0000 if there is no memory card)   | K byte (1 word = 2 bytes)        |

**CPU Bus Unit configuration (response)**

Each CPU Bus Unit has a code assigned to it consisting of two ASCII characters (two bytes). These codes are given in the numerical order according to the unit number of the CPU Bus Units (unit 0 to 15).

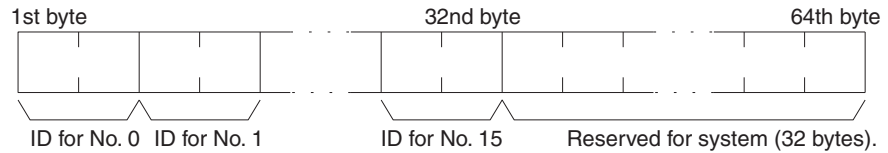

**ID Format**

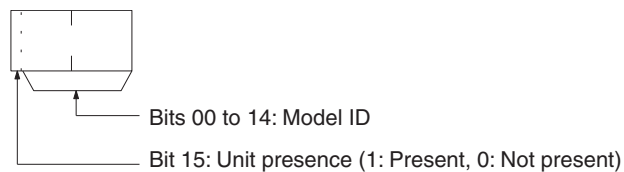

**Remote I/O data (response)**

The number of SYSMAC BUS Master Units mounted in remote I/O systems is returned in a single byte (00 to 02 hex) as follows:

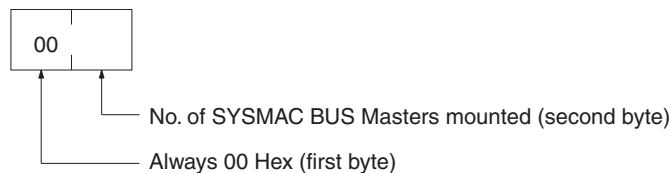

**CPU Unit information (response)**

The total number of racks (CPU Racks + Expansion I/O Racks) connected to the CPU Unit is returned in a single byte (8 bits) of data in the configuration shown below.

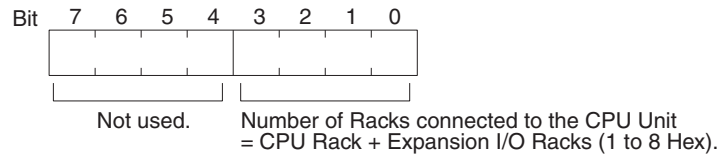

**End code (response)**

Refer to 5-1-3 End Codes for information on end codes.

**5-3-16 CONNECTION DATA READ: 05 02**

Reads the model number of the specified Units.

**Execution Conditions**

|                                     |                           |                                 |                                 |
|-------------------------------------|---------------------------|---------------------------------|---------------------------------|
| <b>Access right at other device</b> | <b>UM read protection</b> | <b>DIP switch UM protection</b> | <b>Network write protection</b> |
| OK                                  | OK                        | OK                              | OK                              |

**Command Format**

|                 |                     |                     |
|-----------------|---------------------|---------------------|
| <b>RUN mode</b> | <b>MONITOR mode</b> | <b>PROGRAM mode</b> |
| OK              | OK                  | OK                  |

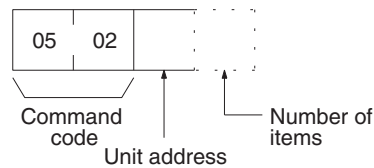

**Response Format**

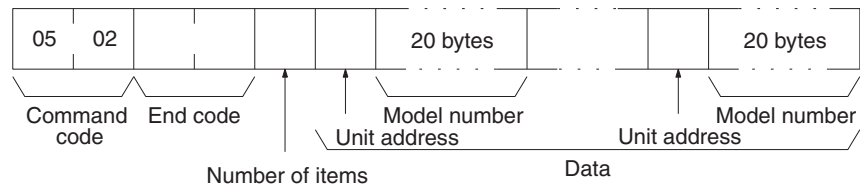

**Parameters**

**Unit address (command and response)**

Specify the unit address of the first Unit whose connection data is to be read. If the specified Unit does not exist, the connection data is read from the next Unit. Specify the following for the unit address.

- CPU Unit: 00 (hex)
- CPU Bus Unit: 10 + unit number (10 to 1F hex)
- Special I/O Unit: 20 + unit number (20 to 7F hex)
- Inner Board: E1 (hex)

**Number of items (command)**

Specify the number of items to be read. The number of items will be returned in order for the number specified, beginning with the unit address set in the "unit address" parameter. Any number between 01 and 19 (hexadecimal) can be specified. If the number of items is not specified, 19 hex (25) will be used.

**Number of Units (response)**

The number of Units for which the connection data is being returned. If bit 7 is ON (1), it means that the data for the last Unit is being returned. The maximum setting is 19 hex (25). If the number of items is not specified, 19 hex (25) will be used.

**Unit address and model number (response)**

These response parameters show the unit address and model number. The model number is provided in up to 20 ASCII characters.

**End code (response)**

Refer to 5-1-3 End Codes for information on end codes.

**5-3-17 CPU UNIT STATUS READ: 06 01**

Reads the operating status of the CPU Unit.

**Execution Conditions**

|                                     |                           |                                       |                                 |
|-------------------------------------|---------------------------|---------------------------------------|---------------------------------|
| <b>Access right at other device</b> | <b>UM read protection</b> | <b>DIP switch UM write protection</b> | <b>Network write protection</b> |
| OK                                  | OK                        | OK                                    | OK                              |

  

|                 |                     |                     |
|-----------------|---------------------|---------------------|
| <b>RUN mode</b> | <b>MONITOR mode</b> | <b>PROGRAM mode</b> |
| OK              | OK                  | OK                  |

**Command Format**

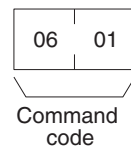

**Response Format**

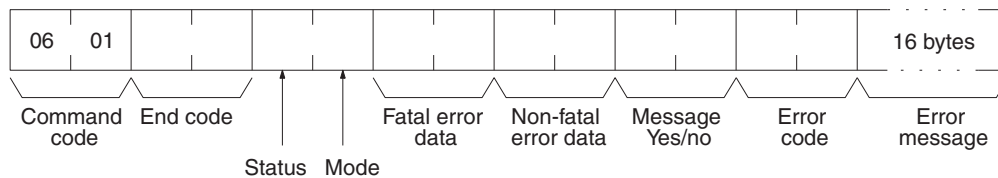

**Parameters**

**Status (response)**

The operating status of the CPU Unit is as shown below. Bits 3 to 6 are undefined. Always mask these bits before accessing them.

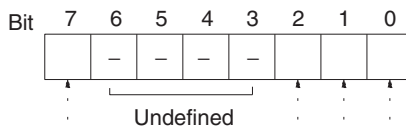

- ..... Status
- ..... 0: Stop (user program is not being executed)
- ..... 1: Run (user program is being executed)
- ..... Built-in flash memory access (CS1-H, CJ1-H, CJ1M, CP1H, NSJ, and CS1D only)
- ..... 0: Not writing, 1: Writing
- ..... Battery status (CS1-H, CJ1-H, CJ1M, CP1H, NSJ, and CS1D only)
- ..... 0: No battery, 1: Battery present
- ..... CPU status
- ..... 0: Normal
- ..... 1: CPU on standby (waiting for a signal from a device, such as a SYSMAC BUS Remote I/O Slave Unit).



**Mode (response)**

The CPU Unit operating mode is as follows:

- 00:** PROGRAM
- 02:** MONITOR
- 04:** RUN

**Fatal error data (response)**

Fatal error data for the CPU Unit is configured as follows:

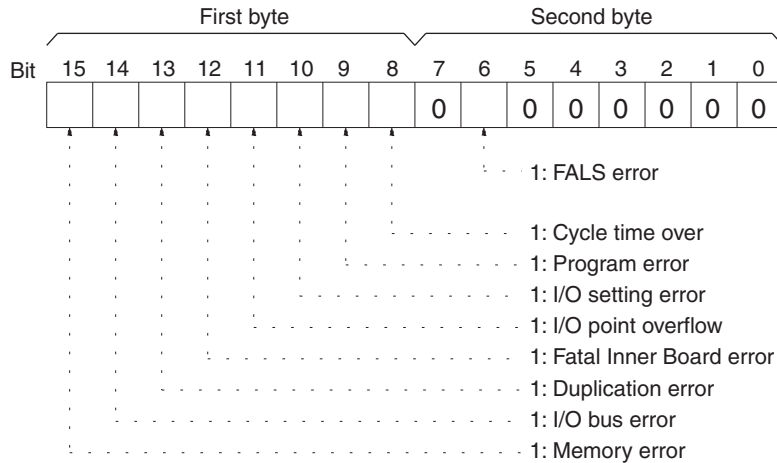

**Non-fatal error data (response)**

Non-fatal error data for the CPU Unit is configured as follows:

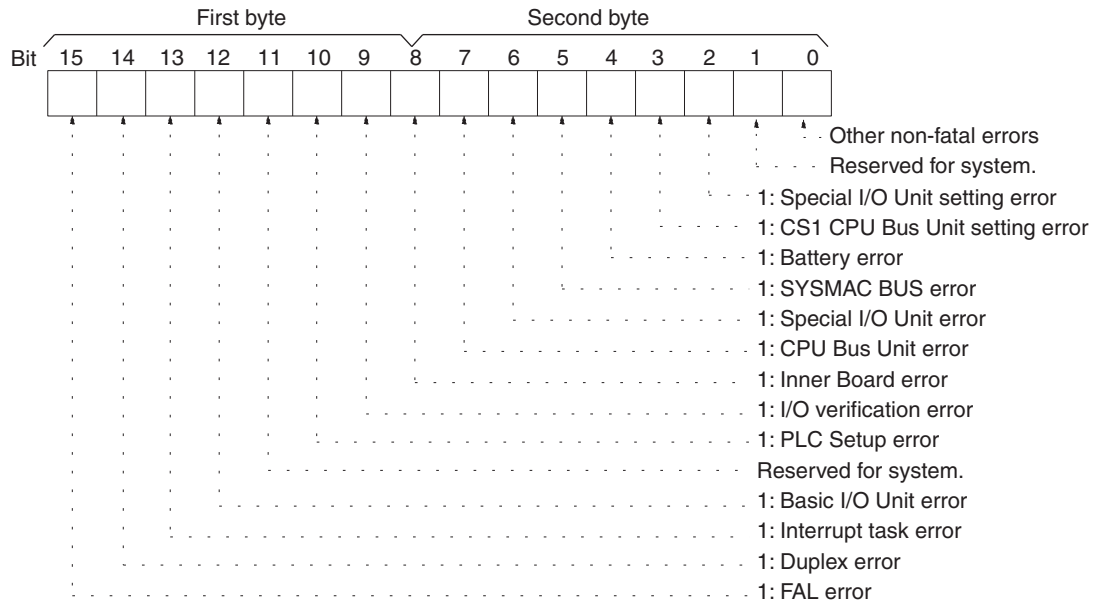

**Note** For details, refer to the CPU Unit's operation manual.

**Message yes/no (response)**

If MSG(046) has been executed, the bit corresponding to the message number will be ON (1) as shown below. To read the messages generated by

MSG(195), execute MESSAGE READ (command code 0920). Refer to 5-3-21 MESSAGE READ: 09 20.

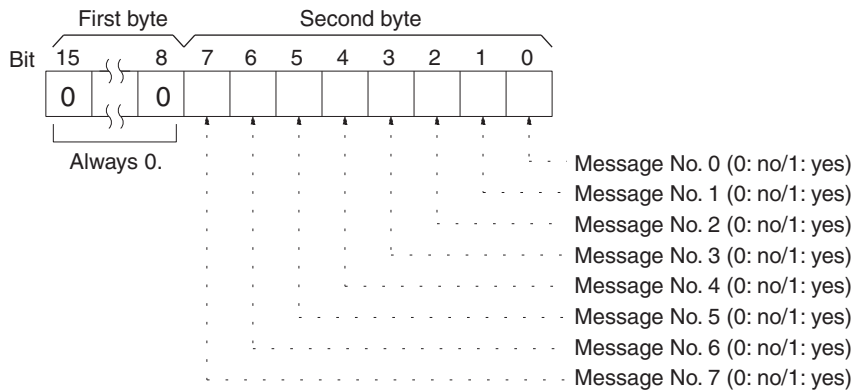

**Error code (response)**

Among errors that occur when the command is executed, the error code indicates the most serious. If there are no errors, it will be 0000 (hex).

**Error message (response)**

Indicates messages from execution of FAL(006) or FALS(007). If there is no error message, or if FAL(006) or FALS(007) are not being executed, 16 spaces (ASCII 20) will be returned.

**End code (response)**

Refer to 5-1-3 End Codes for information on end codes.

**Comments**

To read the error log, read the appropriate Auxiliary Area words or execute ERROR LOG READ command (command code 2102). Refer to 5-3-28 ERROR LOG READ: 21 02.

**5-3-18 CYCLE TIME READ: 06 20**

Initializes the PLC's cycle time history or reads the average, maximum, and minimum cycle time.

**Execution Conditions**

|                              |                    |                                |                          |
|------------------------------|--------------------|--------------------------------|--------------------------|
| Access right at other device | UM read protection | DIP switch UM write protection | Network write protection |
| OK                           | OK                 | OK                             | OK                       |

|          |              |              |
|----------|--------------|--------------|
| RUN mode | MONITOR mode | PROGRAM mode |
| OK       | OK           | No           |

**Command Format**

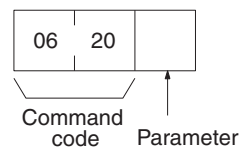

**Response Format**

The response format is as follows when the parameter is 00 hex:

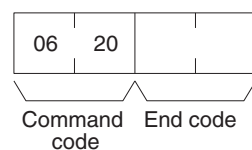

The response format is as follows when the parameter is 01 hex (read):

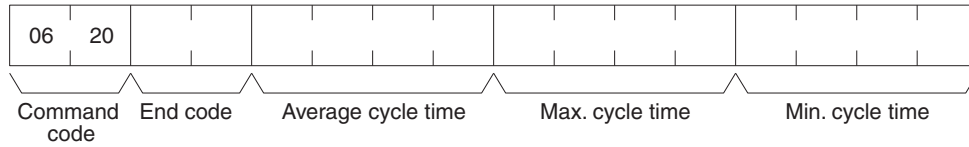

**Parameters**

**Parameter code (command)**

Specify the operations for this command as follows:

**00 (hex):** Initializes the cycle time.

**01 (hex):** Reads the average, maximum, and minimum cycle time.

**Average cycle time (response)**

The CPU Unit continuously calculates the cycle time, and remembers the previous eight cycle times. The “average cycle times” is the average of these eight cycle times, expressed as four bytes of binary data in 0.1-ms increments.

The average cycle time is obtained as follows:

$$\text{Average cycle time} = (\text{Sum of 8 previous cycle times})/8$$

In the following example the average cycle time is 65.0 ms.

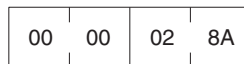

**Maximum cycle time**

The maximum cycle time is the maximum value, of the cycle time measured after the cycle time initialize request is received. It is expressed in four binary bytes, in increments of 0.1 ms.

**Minimum cycle time**

The minimum cycle time is found in the same way as the maximum cycle time described above.

**End code (response)**

Refer to 5-1-3 End Codes for information on end codes.

**Comments**

The maximum and minimum cycle times are initialized when operation is started.

**5-3-19 CLOCK READ: 07 01**

Reads clock information.

**Execution Conditions**

| Access right at other device | UM read protection | DIP switch UM write protection | Network write protection |
|------------------------------|--------------------|--------------------------------|--------------------------|
| OK                           | OK                 | OK                             | OK                       |

| RUN mode | MONITOR mode | PROGRAM mode |
|----------|--------------|--------------|
| OK       | OK           | OK           |

**Command Format**

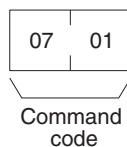

Response Format

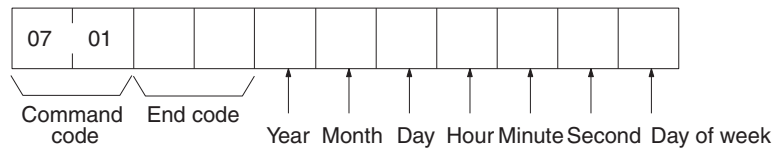

Parameters

**Year, month, day, hour, minute, second, day of week (response)**

The year, month, day of month, hour, minute, and second are expressed in BCD.

**Year:** The rightmost two digits of the year. (1998, 1999, and 2000 are expressed as 98, 99, and 00 respectively. 2096 and 2097 will be expressed as 96 and 97.)

**Hour:** 00 to 23 (BCD).

**Day of week:** As follows:

| Value (hex) | 00  | 01  | 02   | 03  | 04   | 05  | 06  |
|-------------|-----|-----|------|-----|------|-----|-----|
| Day of week | Sun | Mon | Tues | Wed | Thur | Fri | Sat |

**End code (response)**

Refer to 5-1-3 End Codes for information on end codes.

5-3-20 CLOCK WRITE: 07 02

Writes clock information.

Execution Conditions

| Access right at other device | UM read protection | DIP switch UM write protection | Network write protection |
|------------------------------|--------------------|--------------------------------|--------------------------|
| No                           | OK                 | OK                             | No                       |

  

| RUN mode | MONITOR mode | PROGRAM mode |
|----------|--------------|--------------|
| OK       | OK           | OK           |

Command Format

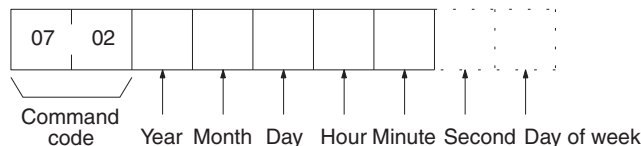

Response Format

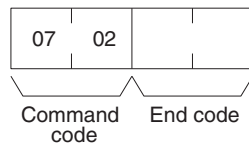

Parameters

**Year, month, day, hour, minute, second, day of week (response)**

The year, month, day of month, hour, minute, and second are expressed in BCD.

**Year:** The rightmost two digits of the year. (1998, 1999, and 2000 are expressed as 98, 99, and 00 respectively. 2096 and 2097 will be expressed as 96 and 97.)

**Hour:** 00 to 23 (BCD).

**Day of week:** As follows:

|                    |           |           |           |           |           |           |           |
|--------------------|-----------|-----------|-----------|-----------|-----------|-----------|-----------|
| <b>Value (hex)</b> | <b>00</b> | <b>01</b> | <b>02</b> | <b>03</b> | <b>04</b> | <b>05</b> | <b>06</b> |
| <b>Day of week</b> | Sun       | Mon       | Tues      | Wed       | Thur      | Fri       | Sat       |

**End code (response)**

Refer to 5-1-3 End Codes for information on end codes.

**Comments**

If the second and the day of week are not specified, 00 (BCD) will be set as the second and the previous value will be kept for the day.

If the second is specified, but the day of week is omitted, the previous setting will not be changed.

The PLC does not check the day of week from the day of month. This means that no error will occur even if the day of month and the day of week do not agree.

The PLC automatically checks the range of the specified data. If any portion of the data is incorrect, the clock will not be set.

**5-3-21 MESSAGE READ: 09 20**

Reads messages generated by MSG(195).

**Execution Conditions**

|                                     |                           |                                       |                                 |
|-------------------------------------|---------------------------|---------------------------------------|---------------------------------|
| <b>Access right at other device</b> | <b>UM read protection</b> | <b>DIP switch UM write protection</b> | <b>Network write protection</b> |
| OK                                  | OK                        | OK                                    | OK                              |

|                 |                     |                     |
|-----------------|---------------------|---------------------|
| <b>RUN mode</b> | <b>MONITOR mode</b> | <b>PROGRAM mode</b> |
| OK              | OK                  | OK                  |

**Command Format**

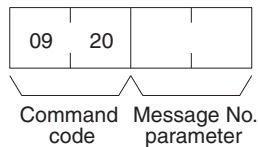

**Response Format**

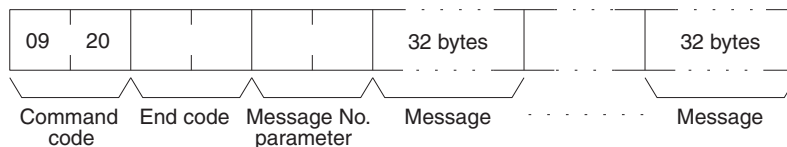

**Parameters**

**Message number parameter (command and response)**

In the command format, turn ON (1) the bits of the messages to be read. In the response format, the bits of the messages being returned will be ON (1). If no bits are turned ON in the command format, all bits will be OFF (0) in the response format and no further data will be returned.

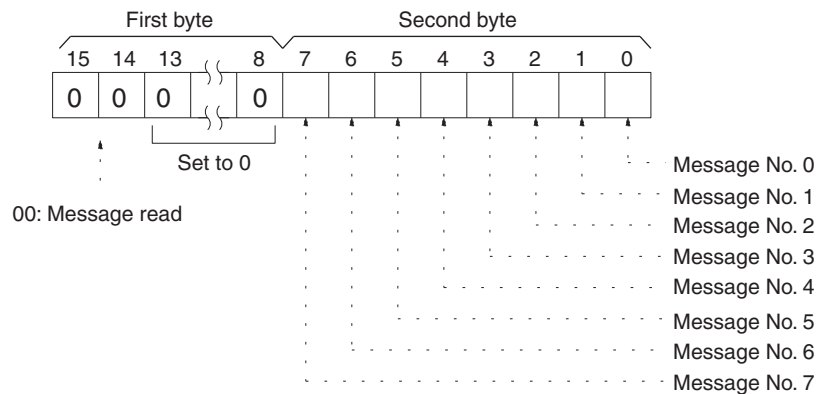

**Message (response)**

Each message is returned in numerical order, from smaller to larger, according to the message number. Each message consists of 32 ASCII characters (32 bytes). The total number of bytes of the messages is calculated as follows:

$$\text{The number of messages read} \times 32 \text{ bytes}$$

If a message consists of less than 32 bytes, the remainder will be filled with spaces (20 hex). If no message has been registered for a message number that has been requested, 32 bytes of spaces (20 hex) will be returned.

**End code (response)**

Refer to 5-1-3 End Codes for information on end codes.

**Comments**

The MESSAGE READ, MESSAGE CLEAR (refer to 5-3-22 MESSAGE CLEAR: 09 20), and FAL/FALS READ (refer to 5-3-23 FAL/FALS READ: 09 20) commands share the same command code (0920). They are distinguished by bits 14 and 15 of the two-byte parameter following the command code. To read MSG(195) messages, bits 14 and 15 must be OFF (0).

**5-3-22 MESSAGE CLEAR: 09 20**

Clears messages generated with MSG(195).

**Execution Conditions**

| Access right at other device | UM read protection | DIP switch UM write protection | Network write protection |
|------------------------------|--------------------|--------------------------------|--------------------------|
| No (when clearing messages)  | OK                 | OK                             | OK                       |

| RUN mode | MONITOR mode | PROGRAM mode |
|----------|--------------|--------------|
| OK       | OK           | OK           |

**Command Format**

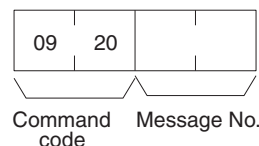

**Response Format**

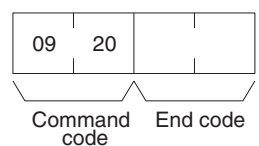

Parameters

**Message number (command)**

Turn ON the bits of the messages to be cleared. Multiple messages can be cleared at one time.

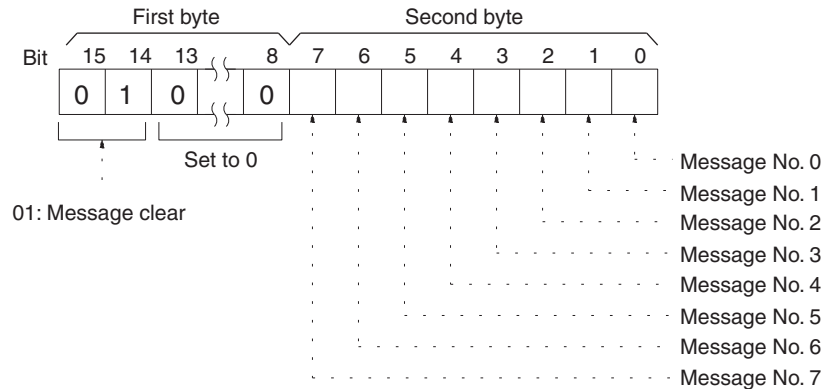

**End code (response)**

Refer to 5-1-3 End Codes for information on end codes.

Comments

The MESSAGE READ, MESSAGE CLEAR (refer to 5-3-22 MESSAGE CLEAR: 09 20), and FAL/FALS READ (refer to 5-3-23 FAL/FALS READ: 09 20) commands share the same command code (0920). They are distinguished by bits 14 and 15 of the two-byte parameter following the command code. To clear messages, bit 14 must be ON (0) and bit 15 must be OFF (0).

**5-3-23 FAL/FALS READ: 09 20**

Reads FAL(006)/FALS(007) error messages.

Execution Conditions

|                                     |                           |                                       |                                 |
|-------------------------------------|---------------------------|---------------------------------------|---------------------------------|
| <b>Access right at other device</b> | <b>UM read protection</b> | <b>DIP switch UM write protection</b> | <b>Network write protection</b> |
| OK                                  | OK                        | OK                                    | OK                              |

  

|                 |                     |                     |
|-----------------|---------------------|---------------------|
| <b>RUN mode</b> | <b>MONITOR mode</b> | <b>PROGRAM mode</b> |
| OK              | OK                  | OK                  |

Command Format

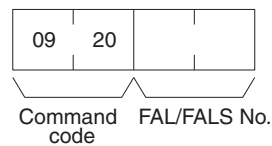

Response Format

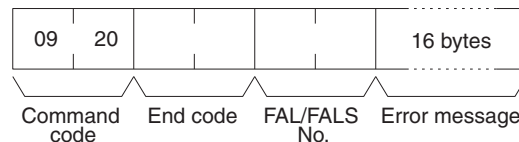

Parameters

**FAL/FALS No. (command and response)**

In the command format, specify in hexadecimal in bits 0 to 13 the FAL or

FALS number to be read as shown below. In the response format, the FAL or FALS number is returned.

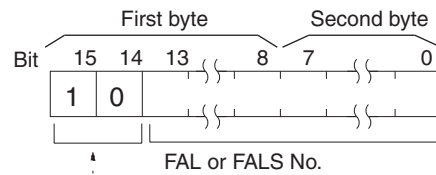

10: FAL/FALS READ (returned as 00 in the response)

**Error message (response)**

The error message specified in the FAL(006) or FALS(007) instruction.

A single error message consists of 16 ASCII characters.

If a message consists of less than 16 bytes, spaces (20 hex) will be returned for the remainder. If no message has been registered for a message number that has been requested, 16 bytes of spaces (20 hex) will be returned.

Message data will be returned as is even if a control code such as CR (0D hex) is included in the message data.

**End code (response)**

Refer to 5-1-3 End Codes for information on end codes.

**Comments**

The MESSAGE READ, MESSAGE CLEAR (refer to 5-3-22 MESSAGE CLEAR: 09 20), and FAL/FALS READ (refer to 5-3-23 FAL/FALS READ: 09 20) commands share the same command code (0920). They are distinguished by bits 14 and 15 of the two-byte parameter following the command code. To read FAL/FALS messages, bit 14 must be OFF (0) and bit 15 must be ON (1).

**5-3-24 ACCESS RIGHT ACQUIRE: 0C 01**

Acquires the access right as long as no other device holds it. Execute the ACCESS RIGHT ACQUIRE command when you need to execute commands continuously without being interrupted by other devices. As soon as the execution of the commands has been completed, execute ACCESS RIGHT RELEASE (command code 0C03) to release the access right. (Refer to 5-3-26 ACCESS RIGHT RELEASE: 0C 03.) If another devices holds the access right, the device will be identified in the response.

**Execution Conditions**

| Access right at other device | UM read protection | DIP switch UM write protection | Network write protection |
|------------------------------|--------------------|--------------------------------|--------------------------|
| No                           | OK                 | OK                             | No                       |

| RUN mode | MONITOR mode | PROGRAM mode |
|----------|--------------|--------------|
| OK       | OK           | OK           |

**Command Format**

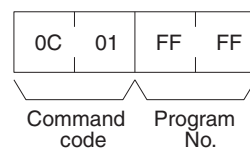



Response Format

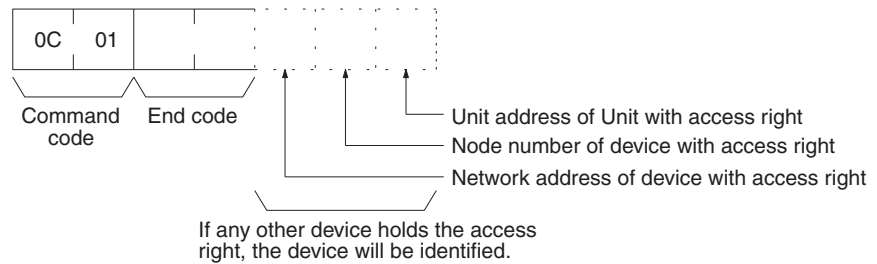

Parameters

**Program No. (command)**

Always FFFF (hex).

**End code (response)**

Refer to 5-1-3 End Codes for information on end codes.

Comments

If any other device has the access right, the access right cannot be acquired with this command; use ACCESS RIGHT FORCED ACQUIRE (command code 0C01). (Refer to 5-3-25 ACCESS RIGHT FORCED ACQUIRE: 0C 02.)

When ACCESS RIGHT ACQUIRE (command code 0C01) is executed while any other device has the access right, subsequent commands cannot be executed from the other device. This command should generally not be used during normal processing.

The following table shows which FINS commands can be executed even when another device holds the access right.

| Command code | Command name                | Command execution while another device has access right |
|--------------|-----------------------------|---|
| 0101         | MEMORY AREA READ            | Yes   |
| 0102         | MEMORY AREA WRITE           | Yes   |
| 0103         | MEMORY AREA FILL            | Yes   |
| 0104         | MULTIPLE MEMORY AREA READ   | Yes   |
| 0105         | MEMORY AREA TRANSFER        | Yes   |
| 0201         | PARAMETER AREA READ         | Yes   |
| 0202         | PARAMETER AREA WRITE        | No  |
| 0203         | PARAMETER AREA CLEAR        | No  |
| 0306         | PROGRAM AREA READ           | Yes   |
| 0307         | PROGRAM AREA WRITE          | No  |
| 0308         | PROGRAM AREA 5CLEAR         | No  |
| 0401         | RUN                         | No  |
| 0402         | STOP                        | No  |
| 0501         | CPU UNIT DATA READ          | Yes   |
| 0502         | CONNECTION DATA READ        | Yes   |
| 0601         | CPU UNIT STATUS READ        | Yes   |
| 0620         | CYCLE TIME READ             | Yes   |
| 0701         | CLOCK READ                  | Yes   |
| 0702         | CLOCK WRITE                 | No  |
| 0920         | MESSAGE READ/CLEAR          | No  |
| 0C01         | ACCESS RIGHT ACQUIRE        | No  |
| 0C02         | ACCESS RIGHT FORCED ACQUIRE | Yes   |

| Command code | Command name  | Command execution while another device has access right |
|--------------|---|---|
| 0C03         | ACCESS RIGHT RELEASE  | Yes   |
| 2101         | ERROR CLEAR   | No  |
| 2102         | ERROR LOG READ  | Yes   |
| 2103         | ERROR LOG CLEAR   | No  |
| 2140         | FINS WRITE ACCESS LOG READ                                    | Yes   |
| 2141         | FINS WRITE ACCESS LOG CLEAR                                   | No  |
| 2201         | FILE NAME READ  | Yes   |
| 2202         | SINGLE FILE READ  | Yes   |
| 2203         | SINGLE FILE WRITE   | No  |
| 2204         | FILE MEMORY FORMAT  | No  |
| 2205         | FILE DELETE   | No  |
| 2207         | FILE COPY   | No  |
| 2208         | FILE NAME CHANGE  | No  |
| 220A         | MEMORY AREA-FILE TRANSFER (I/O memory to file transfers only) | No  |
| 220B         | PARAMETER AREA-FILE TRANSFER                                  | No  |
| 220C         | PROGRAM AREA-FILE TRANSFER                                    | No  |
| 2215         | CREATE/DELETE DIRECTORY                                       | No  |
| 2220         | MEMORY CASSETTE TRANSFER                                      | No  |
| 2301         | FORCED SET/RESET  | Yes   |
| 2302         | FORCED SET/RESET CANCEL                                       | Yes   |

**Note** ACCESS RIGHT ACQUIRE is used to prevent Programming Devices or other Units from taking the access right when more than one command is to be executed in succession. When finished, always execute ACCESS RIGHT RELEASE (0C03).

### 5-3-25 ACCESS RIGHT FORCED ACQUIRE: 0C 02

Acquires the access right even if another device already holds it.

#### Execution Conditions

| Access right at other device | UM read protection | DIP switch UM write protection | Network write protection |
|------------------------------|--------------------|--------------------------------|--------------------------|
| OK                           | OK                 | OK                             | OK                       |

| RUN mode | MONITOR mode | PROGRAM mode |
|----------|--------------|--------------|
| OK       | OK           | OK           |

#### Command Format

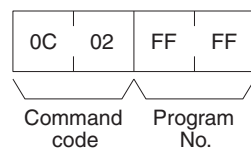

#### Response Format

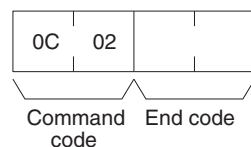

**Parameters**

**Program number (command)**

Always FFFF (hex).

**End code (response)**

Refer to 5-1-3 End Codes for information on end codes.

**Comments**

Even if any other device has the access right, the access right can be acquired with this command and a normal end code will be returned.

When ACCESS RIGHT FORCED ACQUIRE (command code 0C02) is executed while any other device has the access right, subsequent commands cannot be executed from the other device. This command should generally not be used during normal processing.

The following table shows which FINS commands can be executed even when another device holds the access right.

| Command code | Command name                | Command execution while another device has access right |
|--------------|-----------------------------|---|
| 0101         | MEMORY AREA READ            | Yes   |
| 0102         | MEMORY AREA WRITE           | Yes   |
| 0103         | MEMORY AREA FILL            | Yes   |
| 0104         | MULTIPLE MEMORY AREA READ   | Yes   |
| 0105         | MEMORY AREA TRANSFER        | Yes   |
| 0201         | PARAMETER AREA READ         | Yes   |
| 0202         | PARAMETER AREA WRITE        | No  |
| 0203         | PARAMETER AREA CLEAR        | No  |
| 0306         | PROGRAM AREA READ           | Yes   |
| 0307         | PROGRAM AREA WRITE          | No  |
| 0308         | PROGRAM AREA CLEAR          | No  |
| 0401         | RUN                         | No  |
| 0402         | STOP                        | No  |
| 0501         | CPU UNIT DATA READ          | Yes   |
| 0502         | CONNECTION DATA READ        | Yes   |
| 0601         | CPU UNIT STATUS READ        | Yes   |
| 0620         | CYCLE TIME READ             | Yes   |
| 0701         | CLOCK READ                  | Yes   |
| 0702         | CLOCK WRITE                 | No  |
| 0920         | MESSAGE CLEAR               | No  |
| 0C01         | ACCESS RIGHT ACQUIRE        | No  |
| 0C02         | ACCESS RIGHT FORCED ACQUIRE | Yes   |
| 0C03         | ACCESS RIGHT RELEASE        | Yes   |
| 2101         | ERROR CLEAR                 | No  |
| 2102         | ERROR LOG READ              | Yes   |
| 2103         | ERROR LOG CLEAR             | No  |
| 2140         | FINS WRITE ACCESS LOG READ  | Yes   |
| 2141         | FINS WRITE ACCESS LOG CLEAR | No  |
| 2201         | FILE NAME READ              | Yes   |
| 2202         | SINGLE FILE READ            | Yes   |
| 2203         | SINGLE FILE WRITE           | No  |
| 2204         | FILE MEMORY FORMAT          | No  |
| 2205         | FILE DELETE                 | No  |
| 2207         | FILE COPY                   | No  |
| 2208         | FILE NAME CHANGE            | No  |

| Command code | Command name  | Command execution while another device has access right |
|--------------|---|---|
| 220A         | MEMORY AREA-FILE TRANSFER (I/O memory to file transfers only) | No  |
| 220B         | PARAMETER AREA-FILE TRANSFER                                  | No  |
| 220C         | PROGRAM AREA-FILE TRANSFER                                    | No  |
| 2215         | CREATE/DELETE DIRECTORY                                       | No  |
| 2220         | MEMORY CASSETTE TRANSFER                                      | No  |
| 2301         | FORCED SET/RESET  | Yes   |
| 2302         | FORCED SET/RESET CANCEL                                       | Yes   |

If this command is executed when another device holds the access right, any processing being executed by that other device will be aborted. If possible, wait until all processing has been completed and then execute ACCESS RIGHT ACQUIRE (command code 0C01). (Refer to 5-3-24 ACCESS RIGHT ACQUIRE: 0C 01.)

When the access right is forcibly acquired by this command, the device losing the access right is not notified.

### 5-3-26 ACCESS RIGHT RELEASE: 0C 03

Releases the access right regardless of what device holds it.

#### Execution Conditions

| Access right at other device | UM read protection | DIP switch UM write protection | Network write protection |
|------------------------------|--------------------|--------------------------------|--------------------------|
| OK                           | OK                 | OK                             | OK                       |

  

| RUN mode | MONITOR mode | PROGRAM mode |
|----------|--------------|--------------|
| OK       | OK           | OK           |

#### Command Format

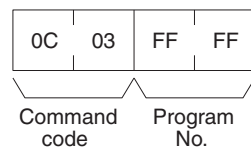

#### Response Format

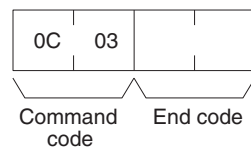

#### Parameters

**Program number (command)**

Always FFFF (hex).

**End code (response)**

Refer to 5-1-3 End Codes for information on end codes.

#### Comments

The access right can be released by this command even when the access right is held by another device. In that case a normal end code will be returned. A normal end code will also be returned if this command is used when the access right is already released.

### 5-3-27 ERROR CLEAR: 21 01

Clears errors or error messages.

**Execution Conditions**

|                                     |                           |                                       |                                 |
|-------------------------------------|---------------------------|---------------------------------------|---------------------------------|
| <b>Access right at other device</b> | <b>UM read protection</b> | <b>DIP switch UM write protection</b> | <b>Network write protection</b> |
| No                                  | OK                        | OK                                    | OK                              |

  

|                 |                     |                     |
|-----------------|---------------------|---------------------|
| <b>RUN mode</b> | <b>MONITOR mode</b> | <b>PROGRAM mode</b> |
| OK              | OK                  | OK                  |

**Command Format**

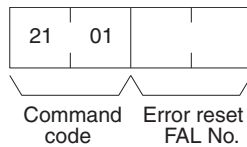

**Response Format**

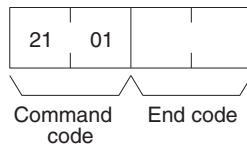

**Parameters**

**Error code to reset (command)**

The code of the error to be reset.

The following codes can be used regardless of the operating mode of the CPU Unit:

| Error code (hex) | Meaning   |
|------------------|---|
| FFFF             | All errors cleared. Resets the all errors that are currently recorded. (This code can be used in PROGRAM mode only.)  |
| FFFE             | Present error cleared. Resets the highest priority error.   |
| 0003             | Duplex power supply error   |
| 0010             | Duplex bus error  |
| 0011             | Duplex verification error   |
| 008A             | Built-in analog I/O error   |
| 008B             | Interrupt task error  |
| 009A             | Basic I/O error   |
| 009B             | PLC Setup error   |
| 00A0 to 00A1     | SYSMAC BUS error  |
| 00D1 to 00D2     | Option Board error  |
| 00E7             | I/O verification error <ul style="list-style-type: none"> <li>• When the registered I/O tables differs from the actual I/O tables</li> <li>• When an I/O Unit has been added or removed</li> </ul>  |
| 00F1             | Flash memory error  |
| 00F7             | Battery error   |
| 0200 to 020F     | CPU Bus Unit error (The rightmost two digits are the unit number in binary of the Unit that has the error.) <ul style="list-style-type: none"> <li>• When a error occurs during data transfer between the CPU Bus Unit and CPU Unit.</li> <li>• When the CPU Bus Unit has a watchdog timer error</li> </ul> |
| 02F0             | Non-fatal Inner Board error   |

|              |   |
|--------------|---|
| 0300 to 035F | Special I/O Unit error (The rightmost two digits are the unit number in binary of the Unit that has the error.)         |
| 0400 to 040F | CPU Bus Unit setting error (The rightmost two digits are the unit number in binary of the Unit that has the error.)     |
| 0500 to 055F | Special I/O Unit setting error (The rightmost two digits are the unit number in binary of the Unit that has the error.) |
| 0600 to 060F | Duplex communications error (The rightmost two digits are the unit number in binary of the Unit that has the error.)    |
| 4101 to 42FF | System error (FAL): FAL(006) was executed.  |

The following codes can be used only when the CPU Unit is in PROGRAM mode:

| Error code (hex) | Meaning   |
|------------------|---|
| FFFF             | All errors cleared.   |
| 809F             | Cycle time too long.  |
| 80C0 to 80C7     | I/O bus error. This error occurs when there is an error in an I/O bus check or a Unit has been removed or added when power is turned on to the PLC.       |
| 80E0             | I/O setting error. This error occurs if the I/O table differs from actual I/O points in the System.   |
| 80E1             | I/O points overflow   |
| 80E9             | Duplication error. This error occurs if the same unit number is assigned to more than one Unit or the same word is allocated more than once.              |
| 80EA             | Basic I/O word duplication resulting from rack first word settings.   |
| 80F0             | Program error.  |
| 80F1             | Memory error. This error occurs if an error is found in the user program, PLC Setup, Registered I/O Tables, routing tables, or CPU Bus Unit Setup memory. |
| 82F0             | Fatal Inner Board error.  |
| C101 to C2FF     | FALS(007) executed.   |

**End code (response)**

Refer to 5-1-3 End Codes for information on end codes.

**Comments**

If the specified error is not occurring, a normal end code will be returned.

If the present error is one that can only be cleared when the CPU Unit is in PROGRAM mode, it will not be possible to clear it in MONITOR or RUN mode.

The cause of the error must be removed before executing ERROR CLEAR (command code 2101) or the same error will immediately occur again after the command is executed.

**5-3-28 ERROR LOG READ: 21 02**

Reads the PLC's error log.

**Execution Conditions**

| Access right at other device | UM read protection | DIP switch UM write protection | Network write protection |
|------------------------------|--------------------|--------------------------------|--------------------------|
| OK                           | OK                 | OK                             | OK                       |

**Command Format**

| RUN mode | MONITOR mode | PROGRAM mode |
|----------|--------------|--------------|
| OK       | OK           | OK           |

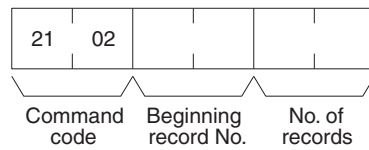

**Response Format**

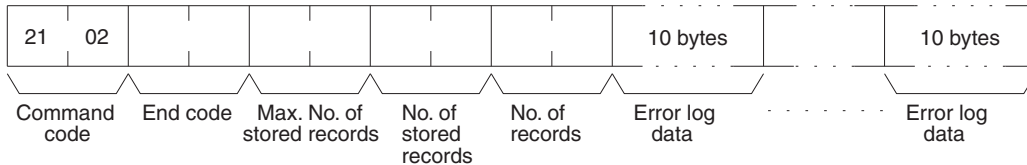

**Parameters**

**Beginning record number (command)**

Specify the first record to be read. (The first record number is 0000 hex.)

**Number of records (command, response)**

Specify the number of records to read. The number of read records will be returned with the response.

**Maximum number of stored records (response)**

Indicates the maximum number of records that can be stored. (Always 20 records.)

**Number of stored records (response)**

Indicates the number of records recorded at the time the command is executed.

**Error log data (response)**

The specified error log records will be returned in sequence starting from the beginning record number. The total number of bytes required is calculated as follows:

$$\text{No. of records} \times 10 \text{ bytes}$$

The configuration of each error record is as follows:

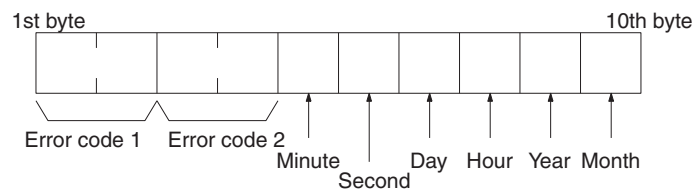

**Error code 1, 2**

Refer to 5-3-27 ERROR CLEAR: 21 01 for information on error codes. Refer to the relevant operation manual or installation guide for more details.

Each data record includes the minute, second, day of month, hour (0 to 23), year (the rightmost two digits), and month in BCD specifying the time that the error occurred.

**End code (response)**

Refer to 5-1-3 End Codes for information on end codes.

**Comments**

The response will contain only the command code and end code if the beginning record number is higher than the number of records contained in the PLC.

When the PLC does not have the specified number of records, all the records that have been stored in the PLC will be read and an address range overflow error will result.

If the data is too large and exceeds the permissible length of the response format, the part in excess will not be read and a normal response will be returned.

### 5-3-29 ERROR LOG CLEAR: 21 03

Clears all error log pointers to 0.

**Execution Conditions**

| Access right at other device | UM read protection | DIP switch UM write protection | Network write protection |
|------------------------------|--------------------|--------------------------------|--------------------------|
| No                           | OK                 | OK                             | No                       |

| RUN mode | MONITOR mode | PROGRAM mode |
|----------|--------------|--------------|
| OK       | OK           | OK           |

**Command Format**

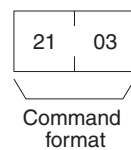

**Response Format**

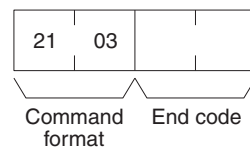

**End code (response)**

Refer to 5-1-3 End Codes for information on end codes.

**Comments**

This command clears the number of error log records that are stored. It does not clear data from the error log area.

### 5-3-30 FINS WRITE ACCESS LOG READ: 21 40

The CPU Unit automatically keeps a log of any access for FINS write commands regardless of the setting. This command reads this log, which tells the nodes and time when there was access.

**Execution Conditions**

| Access right at other device | UM read protection | DIP switch UM write protection | Network write protection |
|------------------------------|--------------------|--------------------------------|--------------------------|
| OK                           | OK                 | OK                             | OK                       |

| RUN mode | MONITOR mode | PROGRAM mode |
|----------|--------------|--------------|
| OK       | OK           | OK           |

**Command Format**

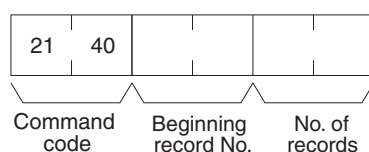



**Response Format**

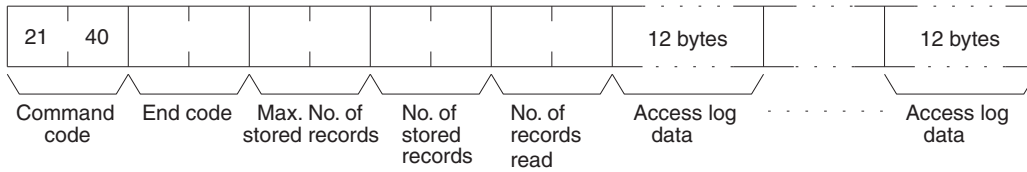

**Parameters**

**Beginning record number (command)**

Specify the first record to be read. (The first record number is 0000 hex.)

**Number of records (command, response)**

Specify the number of records to read. The number of read records will be returned with the response.

**Maximum number of stored records (response)**

Indicates the maximum number of records that can be stored. (Always 20 records.)

**Number of stored records (response)**

Indicates the number of records recorded at the time the command is executed.

**Access log data (response)**

The specified access log records will be returned in sequence starting from the beginning record number. The total number of bytes required is calculated as follows:

$$\text{No. of records} \times 12 \text{ bytes}$$

The configuration of each error record is as follows:

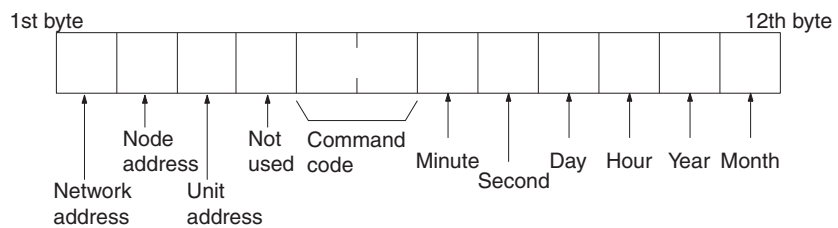

**Network address**

The network address of the node that sent the FINS write command.

**Node address**

The node address of the node that sent the FINS write command.

**Unit address**

The Unit address of the Unit that sent the FINS write command.

**Command code**

The command code of the FINS write command that was received (MR and MS).

**Year, month, day, hour, minute, second, day of week**

The year, month, day of month, hour, minute, and second are expressed in BCD.

**Year:** The rightmost two digits of the year. (1998, 1999, and 2000 are expressed as 98, 99, and 00 respectively. 2096 and 2097 will be expressed as 96 and 97.)

**Hour:** 00 to 23 (BCD).

**End code (response)**

Refer to 5-1-3 End Codes for information on end codes.

**Comments**

An end code of 1103 hex (address range overflow) will be returned if the beginning record number is higher than the number of records contained in the PLC.

When the PLC does not have the specified number of records, all the records that have been stored in the PLC will be read and a normal response will be returned.

If the data is too large and exceeds the permissible length of the response format, the part in excess will not be read and a normal response will be returned.

The following rules apply to records stored in the access log.

- If there is already a record for the same node, the old record will be overwritten with a new one.
- If there is not already a record for the same node, a new record will be created at the end of the log.
- If the log is full (i.e., 20 records have already been stored), the oldest record will be discarded and a new record will be created.

**5-3-31 FINS WRITE ACCESS LOG CLEAR: 21 41**

Clears the access log data.

**Execution Conditions**

|                                     |                           |                                       |                                 |
|-------------------------------------|---------------------------|---------------------------------------|---------------------------------|
| <b>Access right at other device</b> | <b>UM read protection</b> | <b>DIP switch UM write protection</b> | <b>Network write protection</b> |
| No                                  | OK                        | OK                                    | No                              |

  

|                 |                     |                     |
|-----------------|---------------------|---------------------|
| <b>RUN mode</b> | <b>MONITOR mode</b> | <b>PROGRAM mode</b> |
| OK              | OK                  | OK                  |

**Command Format**

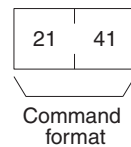

**Response Format**

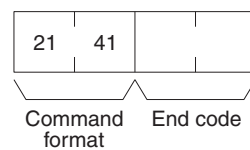

**End code (response)**

Refer to 5-1-3 End Codes for information on end codes.

**Comments**

This command clears the access log data for FINS write commands.

**5-3-32 FILE NAME READ: 22 01**

Reads file data such as the names of files saved in file memory.

**Execution Conditions**

|                                     |                           |                                       |                                 |
|-------------------------------------|---------------------------|---------------------------------------|---------------------------------|
| <b>Access right at other device</b> | <b>UM read protection</b> | <b>DIP switch UM write protection</b> | <b>Network write protection</b> |
| OK                                  | OK                        | OK                                    | OK                              |

  

|                 |                     |                     |
|-----------------|---------------------|---------------------|
| <b>RUN mode</b> | <b>MONITOR mode</b> | <b>PROGRAM mode</b> |
| OK              | OK                  | OK                  |

**Command Format**

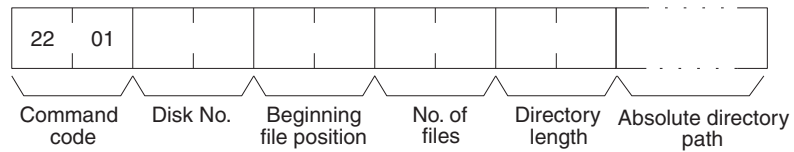

**Response Format**

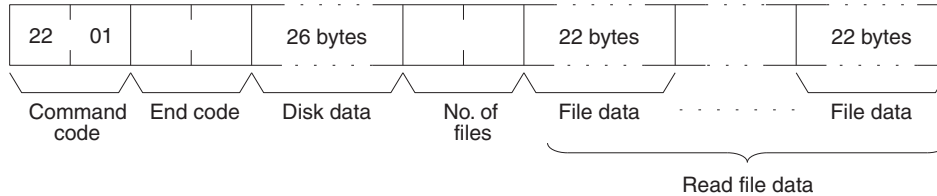

**Parameters**

**Disk number (command)**

The classification of the file memory with the file name to be read is specified as follows:

- 8000 (hex): Memory card
- 8001 (hex): EM file memory

**Beginning file position (command)**

The first file to be read. (The first file number is 0000 hex).

**Number of files (command)**

The number of file names to be read between 0001 and 0014 (hex). A maximum number of 20 file names can be read at one time. If there are more file names than that, add one to the number of response files when specifying the next beginning file position. To read disk data only, specify 0000 (hex) for both the beginning file position and the number of file names. A response will be returned for up to the number of files read.

**Directory length**

Indicates the length of the absolute directory path. The maximum number of characters is 65. To specify the root directory as the absolute directory path, specify 0000 (hex) as the directory length.

**Absolute directory path**

Indicates the absolute path from the root directory. It begins with \ (5C hex), and the drive name and colon (:) are not required. “\” is used to delimit the lower directory. It is not required at the end of the final absolute path. No setting is required to specify the root directory itself.

**Disk data (response)**

Indicates the file memory data. The configuration is as follows:

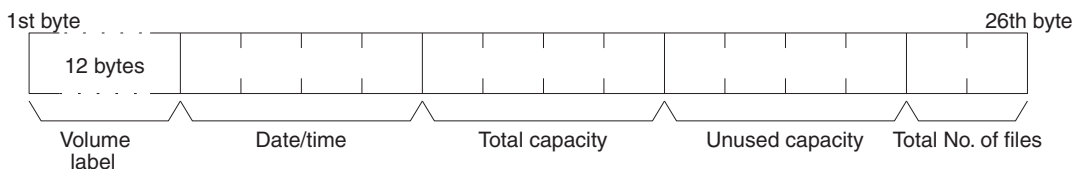

**Volume Label**

The volume label is the name registered with the file memory. For details on the configuration, refer to page 168.

**Date and Time**

The date and time show the date and time that the volume label was created.

**Total Capacity and Open Capacity**

The total capacity and open capacity show the total capacity of the file memory being used and the number of bytes still available (hexadecimal).

**Total Number of Files**

The number of files recorded in the absolute directory path. Volume labels, hidden files, system files, subdirectories, the current directory (indicated by .), and the parent directory (indicated by ..) are all counted as files. (The root directory can contain a volume label, but not a current directory or parent directory mark.)

**Number of files (response)**

The number of files that have been read. Bit 15 is ON (1) if the last file is included.

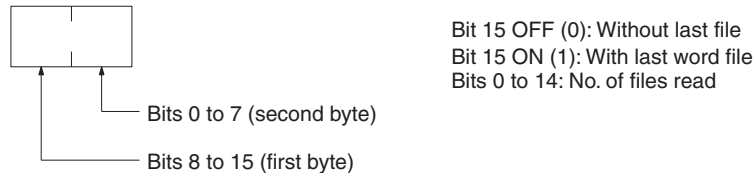

**File data (response)**

Each file data consists of 22 bytes. The specified files will be transmitted in sequence starting from the first file. The total number of bytes required is calculated as follows:

$$\text{Number of read files} \times 22 \text{ bytes}$$

The configuration for each file data is as follows:

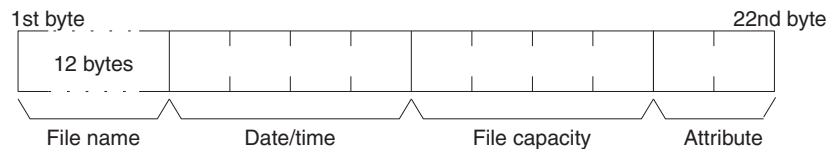

**File Name**

Specify the name of the file. Refer to *Volume Labels and File Names* on page 168 for the structure of file names.

**Date and Time**

Indicates the date and time at which the file was created. (See the note below for details of the configuration.)

**File Capacity**

Indicates the size (the number of bytes, in four digits hexadecimal) of the file.

**Attribute**

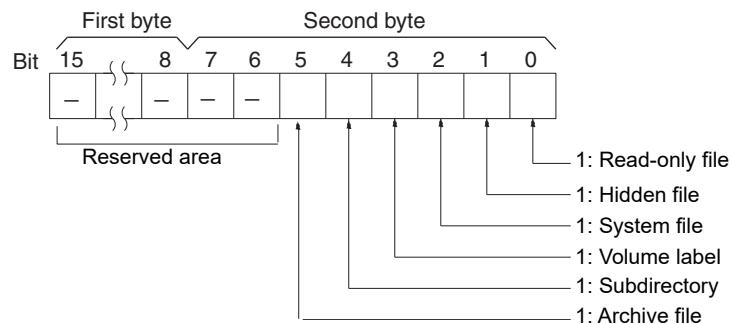

**Note** Date and Time Configuration:

The data and time consists of 4 bytes (32 bits) and is configured in the way shown below.

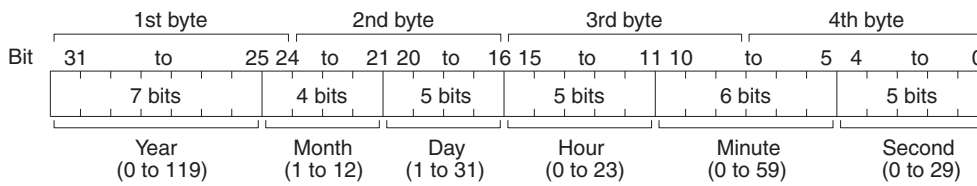

All data values are in binary.

**Year:** Add 1980 to the value returned. (The year is the number of years since 1980.)

**Second:** Multiply the value returned by two. (The value returned is expressed in units of two seconds.)

**End code (response)**

Refer to 5-1-3 End Codes for information on end codes.

**5-3-33 SINGLE FILE READ: 22 02**

Reads the contents of a file stored in the file memory.

**Execution Conditions**

|                                     |                           |                                       |                                 |
|-------------------------------------|---------------------------|---------------------------------------|---------------------------------|
| <b>Access right at other device</b> | <b>UM read protection</b> | <b>DIP switch UM write protection</b> | <b>Network write protection</b> |
| OK                                  | OK                        | OK                                    | OK                              |

  

|                 |                     |                     |
|-----------------|---------------------|---------------------|
| <b>RUN mode</b> | <b>MONITOR mode</b> | <b>PROGRAM mode</b> |
| OK              | OK                  | OK                  |

**Command Format**

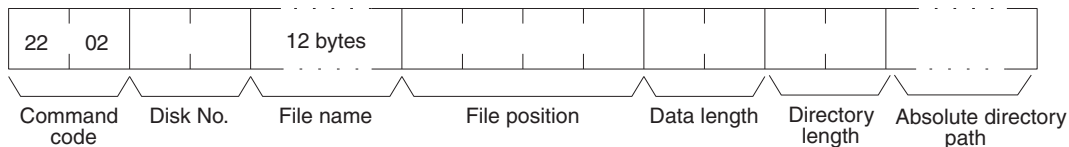

**Response Format**

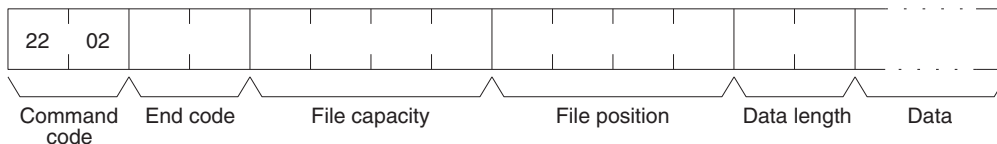

**Parameters**

**Disk number (command)**

The classification of the file memory with the file name to be read is specified as follows:

- 8000 (hex): Memory card
- 8001 (hex): EM file memory

**File name (command)**

Specify the name of the file to be read. For details on the configuration, refer to page 168.

**File position (command)**

Specify the number of bytes (the relative byte address) from the start of the file from which to start reading. (Files start at 00000000 hex.)

**Data length (command)**

Specify the number of bytes of data to read.

**File capacity (response)**

The capacity (bytes) of the file that was read is returned.

**File position (response)**

The position of the first data read is returned.

**Data length (response)**

The number of bytes of data read is returned. If the last data in the file is included, the leftmost bit in this parameter will be ON.

**Data (response)**

The specified data is returned in sequence starting from the specified byte.

**Directory length**

Indicates the length of the absolute directory path. The maximum number of characters is 65. To specify the root directory as the absolute directory path, specify 0000 (hex) as the directory length.

**Absolute directory path**

Indicates the absolute path from the root directory. It begins with \ (5C hex), and the drive name and colon (:) are not required. “\” is used to delimit the lower directory. It is not required at the end of the final absolute path. No setting is required to specify the root directory itself.

**End code (response)**

Refer to 5-1-3 End Codes for information on end codes.

**Comments**

By specifying 0000 (hex) as the file position and data length in the command, is possible to see if the file exists.

**5-3-34 SINGLE FILE WRITE: 22 03**

Writes a new file to the file memory or appends or overwrites an existing file stored in the file memory. Designation can be made to protect existing files if an attempt is made to create a new file of the same name as an existing file.

**Execution Conditions**

|                                     |                           |                                       |                                 |
|-------------------------------------|---------------------------|---------------------------------------|---------------------------------|
| <b>Access right at other device</b> | <b>UM read protection</b> | <b>DIP switch UM write protection</b> | <b>Network write protection</b> |
| No                                  | OK                        | OK                                    | No                              |

  

|                 |                     |                     |
|-----------------|---------------------|---------------------|
| <b>RUN mode</b> | <b>MONITOR mode</b> | <b>PROGRAM mode</b> |
| OK              | OK                  | OK                  |

**Command Format**

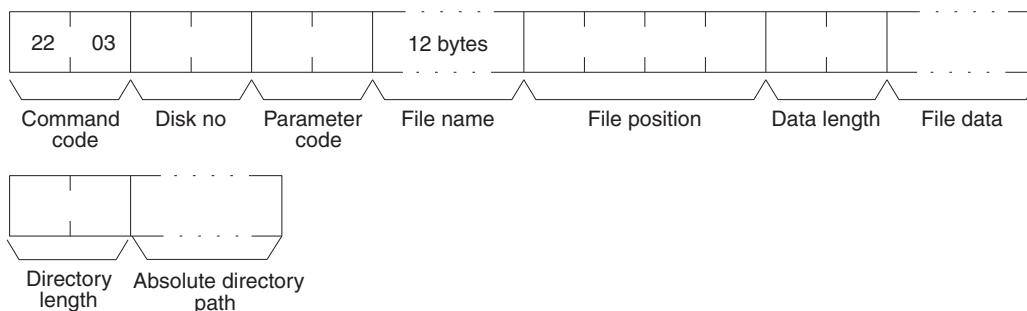

**Response Format**

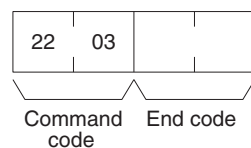

**Parameters****Disk number (command)**

The classification of the file memory with the file name to be read is specified as follows:

8000 (hex): Memory card  
8001 (hex): EM file memory

**Parameter code (command)**

As follows:

**0000 (hex)**

Writes a new file. If a file with the same name already exists, the new file will not be created.

**0001 (hex)**

Writes a new file. If a file with the same name already exists, it will be overwritten.

**0002 (hex)**

Adds data to an existing file.

**0003 (hex)**

Overwrites an existing file.

**File name (command)**

Specifies the name of the file to be written. For details on the configuration, refer to page 168.

**File position (command)**

Specifies the number of bytes from the start of the file from which to start writing. (Files start at 00000000.) To create a new file or add data to an existing file, specify 00000000 as the file position.

**Data length (command)**

Specifies the number of bytes to be written.

**File data (command)**

Specifies the data in sequence from the beginning position, in the amount specified in "data length."

**Directory length (command)**

Indicates the length of the absolute directory path. The maximum number of characters is 65. To specify the root directory as the absolute directory path, specify 0000 (hex) as the directory length.

**Absolute directory path (command)**

Indicates the absolute path from the root directory. It begins with \ (5C hex), and the drive name and colon (:) are not required. "\ " is used to delimit the lower directory. It is not required at the end of the final absolute path. No setting is required to specify the root directory itself.

**End code (response)**

Refer to 5-1-3 End Codes for information on end codes.

**Comments**

If the amount of data to be added to file memory exceeds the available capacity, an Address Range Exceeded error (end code 1104 hex) will occur and the data will not be written. If that occurs, the previous contents of the file specified to be overwritten will not be changed.

When SINGLE FILE WRITE is executed, the clock data of the CPU Unit will be recorded as the date of the file.

**5-3-35 FILE MEMORY FORMAT: 22 04**

Formats file memory. Always execute FILE MEMORY FORMAT (command code 2204) before using a memory card or EM area as file memory.

Execution Conditions

|                              |                    |                                |                          |
|------------------------------|--------------------|--------------------------------|--------------------------|
| Access right at other device | UM read protection | DIP switch UM write protection | Network write protection |
| No                           | OK                 | OK                             | No                       |

  

|          |              |              |
|----------|--------------|--------------|
| RUN mode | MONITOR mode | PROGRAM mode |
| OK       | OK           | OK           |

Command Format

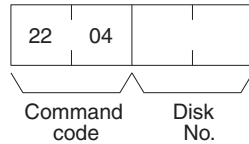

Response Format

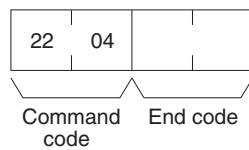

Parameters

**Disk number (command)**

The classification of the file memory to be formatted is specified as follows:

- 8000 (hex): Memory card
- 8001 (hex): EM file memory

**End code (response)**

Refer to 5-1-3 End Codes for information on end codes.

Comments

When FILE MEMORY FORMAT (command code 2204) is executed, all data registered to the file memory will be cleared. Before executing this command, check to be sure that it is okay to clear the data. Refer to file memory application procedures in the CPU Unit's operation manual for details on using file memory.

FILE MEMORY FORMAT is also used to return EM memory that has been converted to file memory back to its original form.

Even if only the size of the file memory is changed, the entire file memory will be formatted.

**Note** If the current EM bank is specified for file conversion in the PLC Setup when FILE MEMORY FORMAT is executed for the EM Area, an Area Missing error (end code 1101) will be returned and a PLC Setup setting error will occur in the CPU Unit. These errors, however, will not occur if the current bank is EM0.

**5-3-36 FILE DELETE: 22 05**

Deletes files registered to file memory.

Execution Conditions

|                              |                    |                                |                          |
|------------------------------|--------------------|--------------------------------|--------------------------|
| Access right at other device | UM read protection | DIP switch UM write protection | Network write protection |
| No                           | OK                 | OK                             | No                       |

|          |              |              |
|----------|--------------|--------------|
| RUN mode | MONITOR mode | PROGRAM mode |
| OK       | OK           | OK           |



**Command Format**

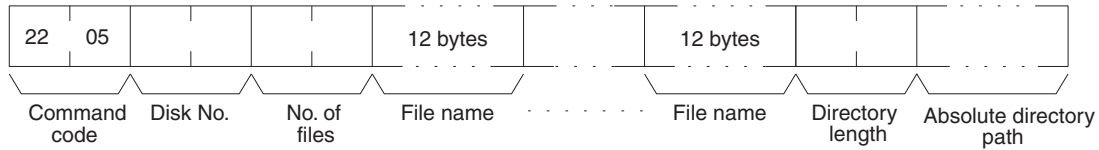

**Response Format**

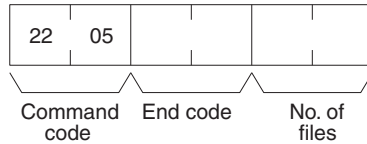

**Parameters**

**Disk number (command)**

The classification of the file memory with the file to be deleted is specified as follows:

- 8000 (hex): Memory card
- 8001 (hex): EM file memory

**Number of files (command)**

Specify the number of files to be deleted.

**File name (command)**

Specify the name of the file to be deleted. For details on the configuration, refer to page 168.

**Directory length**

Indicates the length of the absolute directory path. The maximum number of characters is 65. To specify the root directory as the absolute directory path, specify 0000 (hex) as the directory length.

**Absolute directory path**

Indicates the absolute path from the root directory. It begins with \ (5C hex), and the drive name and colon (:) are not required. “\” is used to delimit the lower directory. It is not required at the end of the final absolute path. No setting is required to specify the root directory itself.

**Number of files (response)**

Indicates the number of files actually deleted.

**End code (response)**

Refer to 5-1-3 End Codes for information on end codes.

**Comments**

The specified files will be deleted in sequence. If non-existing file names have been specified, the PLC will ignore them and the operation will continue.

**5-3-37 FILE COPY: 22 07**

Copies a file from one file memory to another file memory connected to the same CPU Unit.

**Execution Conditions**

|                                     |                           |                                       |                                 |
|-------------------------------------|---------------------------|---------------------------------------|---------------------------------|
| <b>Access right at other device</b> | <b>UM read protection</b> | <b>DIP switch UM write protection</b> | <b>Network write protection</b> |
| No                                  | OK                        | OK                                    | No                              |

  

|                 |                     |                     |
|-----------------|---------------------|---------------------|
| <b>RUN mode</b> | <b>MONITOR mode</b> | <b>PROGRAM mode</b> |
| OK              | OK                  | OK                  |

**Command Format**

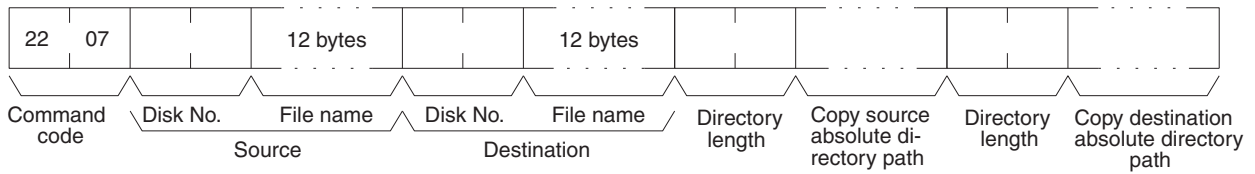

**Response Format**

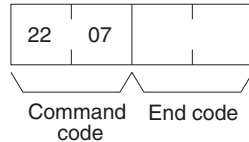

**Parameters**

**Disk number (command)**

The classification of the copy source and copy destination file memory is specified as follows:

- 8000 (hex): Memory card
- 8001 (hex): EM file memory

**File name (command)**

Specify the file to be copied and a new name for the copy destination file.

**Directory length**

Indicates the length of the absolute directory path. The maximum number of characters is 65. To specify the root directory as the absolute directory path, specify 0000 (hex) as the directory length.

**Copy source and copy destination absolute directory path**

Indicates the absolute path from the root directory. It begins with \ (5C hex), and the drive name and colon (:) are not required. “\” is used to delimit the lower directory. It is not required at the end of the final absolute path. No setting is required to specify the root directory itself.

**End code (response)**

Refer to 5-1-3 End Codes for information on end codes.

**Comments**

The file will not be copied if there is already a file of the same name at the destination.

The file will not be copied if an existing file name is given at the copy destination.

The copy destination file is given the same date as the copy source file.

**5-3-38 FILE NAME CHANGE: 22 08**

Changes a registered file name.

**Execution Conditions**

|                                     |                           |                                       |                                 |
|-------------------------------------|---------------------------|---------------------------------------|---------------------------------|
| <b>Access right at other device</b> | <b>UM read protection</b> | <b>DIP switch UM write protection</b> | <b>Network write protection</b> |
| No                                  | OK                        | OK                                    | No                              |
| <b>RUN mode</b>                     | <b>MONITOR mode</b>       | <b>PROGRAM mode</b>                   |                                 |
| OK                                  | OK                        | OK                                    |                                 |

**Command Format**

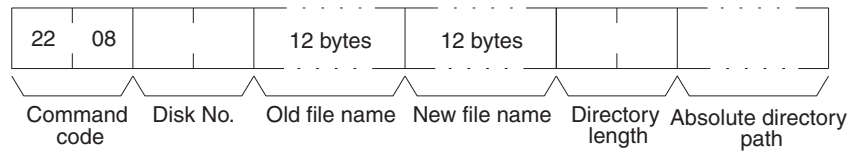

**Response Format**

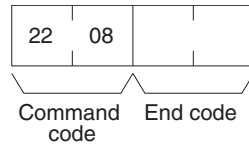

**Parameters**

**Disk number (command)**

The classification of the file memory where the file name to be changed is registered is specified as follows:

- 8000 (hex): Memory card
- 8001 (hex): EM file memory

**Old and new file names (command)**

Specify the original file name and a new name for the file. For details on the configuration, refer to page 168.

**Directory length (command)**

Indicates the length of the absolute directory path. The maximum number of characters is 65. To specify the root directory as the absolute directory path, specify 0000 (hex) as the directory length.

**Absolute directory path (command)**

Indicates the absolute path from the root directory. It begins with \ (5C hex), and the drive name and colon (:) are not required. “\” is used to delimit the lower directory. It is not required at the end of the final absolute path. No setting is required to specify the root directory itself.

**End code (response)**

Refer to 5-1-3 End Codes for information on end codes.

**Comments**

The file name will not be changed if an existing file name is specified for the new file.

Even if the name of a file is changed, the date of the file will remain unchanged.

Directory names can also be changed. Specify the directory name in place of the file name.

**5-3-39 MEMORY AREA–FILE TRANSFER: 22 0A**

Transfers or compares data between the I/O memory areas and the file memory.

**Execution Conditions**

|                                     |                           |                                       |                                 |
|-------------------------------------|---------------------------|---------------------------------------|---------------------------------|
| <b>Access right at other device</b> | <b>UM read protection</b> | <b>DIP switch UM write protection</b> | <b>Network write protection</b> |
| No                                  | OK                        | OK                                    | No                              |

  

|                 |                     |                     |
|-----------------|---------------------|---------------------|
| <b>RUN mode</b> | <b>MONITOR mode</b> | <b>PROGRAM mode</b> |
| OK              | OK                  | OK                  |

**Command Format**

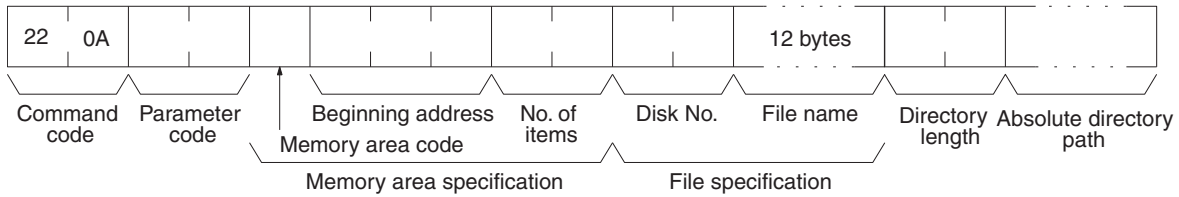

**Response Format**

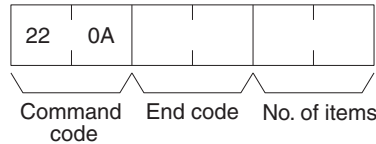

**Parameters**

**Parameter code (command)**

Specify the transfer/compare method as follows:

**0000 (hex)**

Data transfer from the I/O memory area to the file memory.

**0001 (hex)**

Data transfer from the file memory to the I/O memory area.

**0002 (hex)**

Data compared.

**I/O memory area code. Beginning address (command)**

The memory area to be used for data transfer or comparison, and the first address in the memory area to be transferred or compared.

The memory areas that can be written are given in the following table. Refer to 5-2-2 I/O Memory Address Designations for the specific addresses that can be used.

| Area               |                       | Data type | Mode memory area code (hex)         | Bytes per element |
|--------------------|-----------------------|-----------|-------------------------------------|-------------------|
| CIO Area           | CIO                   | Word      | B0                                  | 2                 |
| Work Area          | WR                    |           | B1                                  |                   |
| Holding Bit Area   | HR                    |           | B2                                  |                   |
| Auxiliary Bit Area | AR                    |           | B3                                  |                   |
| Timer Area         | TIM                   | PV        | 89                                  | 2                 |
| Counter Area       | CNT                   |           |                                     |                   |
| DM Area            | DM                    | Word      | 82                                  | 2                 |
| EM Area            | EM bank 0 to bank F   | Word      | A0 to AF (see note.)<br>or 50 to 5F | 2                 |
|                    | EM bank 10 to bank 18 |           | 60 to 68 (see note.)                | 2                 |
|                    | EM current bank       | Word      | 98                                  | 2                 |

**Note** AD to AF/60 to 68 can be specified in the I/O memory type of EM banks D to F/10 to 18 in the CJ2 and the CS1D-CPU68HA only.

50 to 5F can be specified in the I/O memory type of EM banks 0 to F in the CJ2 and the CS1D-CPU68HA only.

**Number of items (command and response)**

In the command format, specify the number of items, in word units, to be transferred or compared. In the response format, this parameter indicates the number of items transferred or successfully compared. Refer to *Element Data Configurations* on page 163 for the configuration of elements.

**Disk number (command)**

The classification of the file memory where the file to be transferred or compared is registered is specified as follows:

- 8000 (hex): Memory card
- 8001 (hex): EM file memory

**File name (command)**

Specify the file to be transferred or compared. For details on the configuration, refer to page 168.

**Directory length**

Indicates the length of the absolute directory path. The maximum number of characters is 65. To specify the root directory as the absolute directory path, specify 0000 (hex) as the directory length.

**Absolute directory path**

Indicates the absolute path from the root directory. It begins with \ (5C hex), and the drive name and colon (:) are not required. “\” is used to delimit the lower directory. It is not required at the end of the final absolute path. No setting is required to specify the root directory itself.

**Comments**

MEMORY AREA–FILE TRANSFER (command code 220A) can be executed regardless of the CPU Unit mode. It is the user’s responsibility to program steps to prohibit this command from being executed when the CPU Unit is in RUN mode if such protection is necessary. Execute CPU UNIT STATUS READ (command code 0601) to read the CPU Unit’s mode. (Refer to 5-3-17 CPU UNIT STATUS READ: 06 01.)

If data is written to the Timer/Counter PV Area, the Completion Flags will not be turned OFF.

The CPU Unit clock data upon completion of MEMORY AREA–FILE TRANSFER (command code 220A) will be recorded as the date of the file that has been transferred.

Files cannot be overwritten when transferring data from a memory area to file memory.

**End code (response)**

Refer to 5-1-3 End Codes for information on end codes.

**5-3-40 PARAMETER AREA–FILE TRANSFER: 22 0B**

Compares or transfers data between the parameter area and the file memory.

**Execution Conditions**

|                                     |                           |                                       |                                 |
|-------------------------------------|---------------------------|---------------------------------------|---------------------------------|
| <b>Access right at other device</b> | <b>UM read protection</b> | <b>DIP switch UM write protection</b> | <b>Network write protection</b> |
| No                                  | OK                        | OK (See note.)                        | No                              |

|                 |                     |                     |
|-----------------|---------------------|---------------------|
| <b>RUN mode</b> | <b>MONITOR mode</b> | <b>PROGRAM mode</b> |
| OK (See note.)  | OK (See note.)      | OK                  |

**Note** Data cannot be transferred from file memory to the parameter area.

**Command Format**

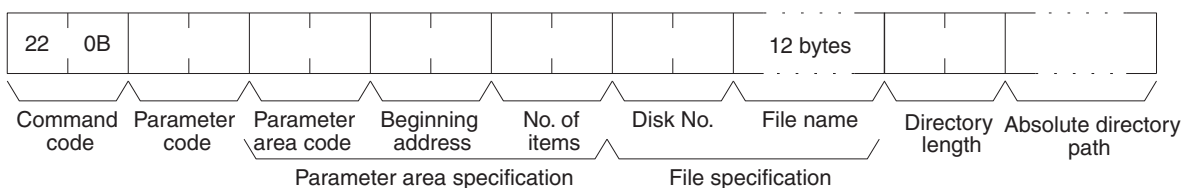

**Response Format**

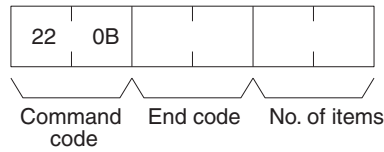

**Parameters**

**Parameter code (command)**

Specify the transfer/compare method as follows:

**0000 (hex)**

Data transfer from the parameter area to the file memory.

**0001 (hex)**

Data transfer from the file memory to the parameter area.

**0002 (hex)**

Data compared.

**Parameter area code (command)**

Specify the parameter area to be used for data transfer or comparison. The rightmost byte is always 80 (hex), and the parameter area is specified with the leftmost byte.

**Beginning address (command)**

Specify the position in the parameter area for beginning the transfer or comparison. The beginning of each parameter area is always 0000.

**Parameter Areas**

There are six parameter areas, each of which has consecutive word addresses beginning from 0000. The areas that can be written to are shown below, along with their parameter area codes.

|                             | Parameter area code | Address range (Hex)        | Parameter area code | Address range (Hex)         |
|-----------------------------|---------------------|----------------------------|---------------------|-----------------------------|
| PLC Setup Area              | 8010                | 0000 to 01FF (512 words)   | 8000                | 0000 to 1F3F<br>8000 words) |
| I/O Table Registration Area | 8012                | 0000 to 04FF (1,280 words) |                     |                             |
| Routing Table Area          | 8013                | 0000 to 01FF (512 words)   |                     |                             |
| CPU Bus Unit Setup Area     | 8002                | 0000 to 143F (5184 words)  |                     |                             |

**Number of items (command and response)**

In the command format, the number of items is always FFFF (hex) so that the entire parameter area is specified. In the response format, the number of words transferred is indicated when data is transferred. When data is compared, the response format indicates the position at which a verification error occurs or the number of words compared.

**Disk number (command)**

The classification of the file memory where the file to be transferred or compared is registered is specified as follows:

- 8000 (hex): Memory card
- 8001 (hex): EM file memory

**File name (command)**

Specify the file to be transferred or compared. For details on the configuration, refer to page 168.

**Directory length (command)**

Indicates the length of the absolute directory path. The maximum number of characters is 65. To specify the root directory as the absolute directory path, specify 0000 (hex) as the directory length.

**Absolute directory path (command)**

Indicates the absolute path from the root directory. It begins with \ (5C hex), and the drive name and colon (:) are not required. “\” is used to delimit the lower directory. It is not required at the end of the final absolute path. No setting is required to specify the root directory itself.

**End code (response)**

Refer to 5-1-3 End Codes for information on end codes.

**Comments**

The clock data upon completion of a parameter area to file memory transfer will be recorded as the date of the file that has been transferred.

A file can be transferred to the I/O table only when the CPU Unit is in PROGRAM mode.

This command cannot be executed if any other device holds the access right.

Files cannot be overwritten when transferring data from the parameter area to file memory.

**5-3-41 PROGRAM AREA-FILE TRANSFER: 22 0C**

Compares or transfers data between the program area and the file memory.

**Execution Conditions**

|                                     |                           |                                       |                                 |
|-------------------------------------|---------------------------|---------------------------------------|---------------------------------|
| <b>Access right at other device</b> | <b>UM read protection</b> | <b>DIP switch UM write protection</b> | <b>Network write protection</b> |
| No                                  | OK                        | No (See Note 1.)                      | No                              |

|                  |                     |                     |
|------------------|---------------------|---------------------|
| <b>RUN mode</b>  | <b>MONITOR mode</b> | <b>PROGRAM mode</b> |
| OK (See note 2.) | OK (See note 2.)    | OK                  |

- Note**
1. Data can be transferred from the program area to the file memory.
  2. Data cannot be transferred from file memory to the program area in these modes.

**Command Format**

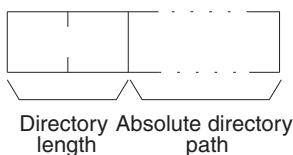
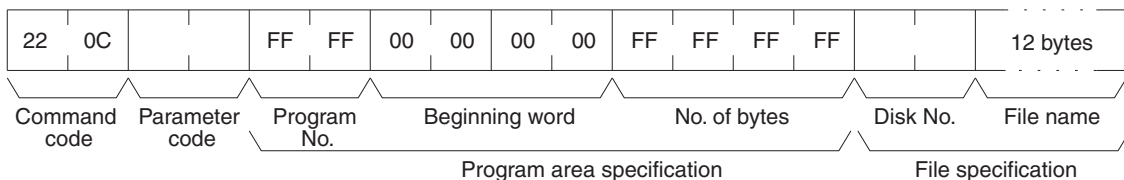

**Response Format**

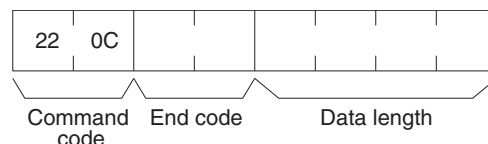

**Parameters**

**Parameter code (command)**

Specify the transfer/compare method as follows:

**0000 (hex)**

Data transfer from the program area to the file memory.

**0001 (hex)**

Data transfer from the file memory to the program area.

**0002 (hex)**

Data compared.

**Program number and beginning word (command)**

Always FFFF (hex).

**Beginning word (command)**

Always 00000000 (hex).

**Number of bytes (command)**

Specify the number of data bytes to be transferred or compared. Always FFFFFFFF (hex).

**Disk number (command)**

The classification of the file memory where the file to be transferred or compared is registered is specified as follows:

8000 (hex): Memory card

8001 (hex): EM file memory

**File name (command)**

Specify the name of the file to be transferred or compared. For details on the configuration, refer to page 168.

**Data length (response)**

When data is transferred, the data length parameter indicates the number of bytes that have been transferred. When data is compared, this parameter indicates the amount of data that was compared with no errors, or the number of bytes compared in a normal completion.

**Directory length (response)**

Indicates the length of the absolute directory path. The maximum number of characters is 65. To specify the root directory as the absolute directory path, specify 0000 (hex) as the directory length.

**Absolute directory path (response)**

Indicates the absolute path from the root directory. It begins with \ (5C hex), and the drive name and colon (:) are not required. “\” is used to delimit the lower directory. It is not required at the end of the final absolute path. No setting is required to specify the root directory itself.

**End code (response)**

Refer to 5-1-3 End Codes for information on end codes.

**Comments**

The clock data upon completion of a program area to file memory transfer will be recorded as the date of the file that has been transferred.

This command cannot be executed if any other device holds the access right or when memory is write-protected via pin 1 of the DIP switch on the front panel of the CPU Unit.

PROGRAM AREA-FILE TRANSFER (command code 220C) cannot be executed when the CPU Unit is in the RUN or MONITOR mode.

Files cannot be overwritten when transferring data from the program area to file memory.

When the “*prohibit save to protected memory card and program transfer (PLC to computer)*” setting is enabled, PROGRAM AREA - FILE TRANSFER cannot be executed.

When the “*prohibit overwriting of protected program*” setting is enabled, FILE - PROGRAM AREA TRANSFER cannot be executed.



### 5-3-42 CREATE/DELETE DIRECTORY: 22 15

Creates or deletes a directory.

**Execution Conditions**

|                                     |                           |                                       |                                 |
|-------------------------------------|---------------------------|---------------------------------------|---------------------------------|
| <b>Access right at other device</b> | <b>UM read protection</b> | <b>DIP switch UM write protection</b> | <b>Network write protection</b> |
| No                                  | OK                        | OK                                    | No                              |

  

|                 |                     |                     |
|-----------------|---------------------|---------------------|
| <b>RUN mode</b> | <b>MONITOR mode</b> | <b>PROGRAM mode</b> |
| OK              | OK                  | OK                  |

**Command Format**

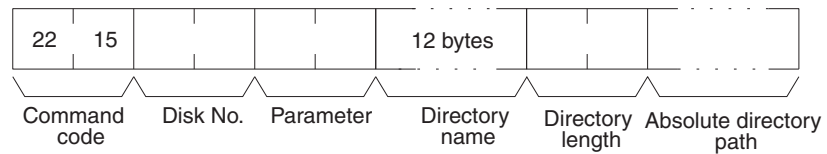

**Response Format**

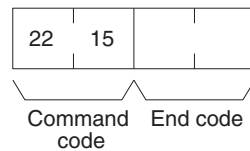

**Parameters**

**Disk number (command)**

The classification of the file memory where the directory is to be created or deleted is specified as follows:

- 8000 (hex): Memory card
- 8001 (hex): EM file memory

**Parameter (command)**

Specify either creation or deletion as follows:

- 0000 (hex): Create
- 0001 (hex): Delete

**Directory name (command)**

Specify the name of the directory to be created or deleted. For details on the configuration, refer to page 168. If the directory name is less than 12 bytes, fill unused bytes with 20 hex.

**Directory length (command)**

Indicates the length of the absolute directory path. The maximum number of characters is 65. To specify the root directory as the absolute directory path, specify 0000 (hex) as the directory length.

**Absolute directory path (command)**

Indicates the absolute path from the root directory. It begins with \ (5C hex), and the drive name and colon (:) are not required. “\” is used to delimit the lower directory. It is not required at the end of the final absolute path. No setting is required to specify the root directory itself.

**End code (response)**

Refer to 5-1-3 End Codes for information on end codes.

**Comments**

The CPU Unit’s clock data will be recorded as the date of any directory that is created.

**5-3-43 MEMORY CASSETTE TRANSFER (CP-series CPU Units Only): 22 20**

Transfers or verifies data between a Memory Cassette mounted in a CP-series CPU Unit (see note) and the memory areas in the CP-series CPU Unit. Transfers can go either direction.

**Note** This command is supported only by CP-series CPU Units (Except CP1E CPU Units).

| Applicable data   | Storage location in CPU Unit                              |
|---|---|
| User program  | RAM (user program area)                                   |
| Parameter area (PLC Setup, CPU Bus Unit settings, and routing tables)   | RAM (parameter area)                                      |
| Symbol table  | Built-in flash memory (Comment Memory Area)               |
| Comments (I/O comments, row comments, and annotations)                  | Built-in flash memory (Comment Memory Area)               |
| Program indices (section names, section comments, and program comments) | Built-in flash memory (Comment Memory Area)               |
| Function block sources  | Built-in flash memory (Function Block Source Memory Area) |
| Data memory   | RAM (DM Area D0 to D32767)                                |
| Data memory initial values  | Built-in flash memory (Data memory initial value area)    |

**Execution Conditions**

| Access right at other device | UM read protection | DIP switch UM write protection | Network write protection |
|------------------------------|--------------------|--------------------------------|--------------------------|
| No                           | OK                 | OK (See note.)                 | No                       |

| RUN mode | MONITOR mode | PROGRAM mode |
|----------|--------------|--------------|
| No       | No           | OK           |

**Note** Data cannot be transferred from the CPU Unit to the Memory Cassette when the user program is included and DIP switch UM protection is set.

**Command Format**

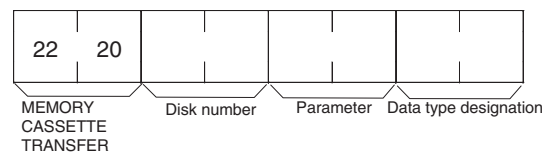

**Response Format**

**Other Memory Cassette Operations (Parameter ≠ 8000 Hex)**

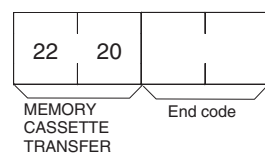

**Reading the Data Type in the Memory Cassette (Parameter = 8000 Hex)**

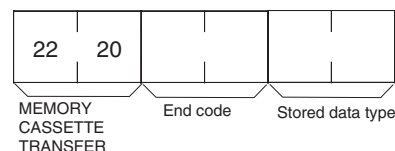

**Parameters**

**Disk number (command)**

Specify the disk for transfer or verification. Only the Memory Cassette can be specified.

8003 (hex): Memory Cassette

**Parameter (command)**

Specify the transfer or verification method.

- 0000 (hex): Transfer (CPU Unit to Memory Cassette)
- 0001 (hex): Transfer (Memory Cassette to CPU Unit)
- 0002 (hex): Verify (between CPU Unit and Memory Cassette)
- 0003 (hex): Initialize Memory Cassette
- 8000 (hex): Read data type in Memory Cassette

**Data type designation (command)**

Bit 15: All or individual area designation (OFF: All, ON: Individual areas)

OFF: All areas for bits 00 and 02 through 07 (See note.)

ON: Only areas specified by bits 00 and 02 through 07 (Multiple bits can be turned ON.)

Bits 14 to 08: Reserved

Bit 07: Data memory initial values

Bit 06: Data memory

Bit 05: Program indices

Bit 04: Comments

Bit 03: Symbol table

Bit 02: parameter area

Bit 01: Reserved

Bit 00: User program + Function block sources

**Note** If bit 15 is OFF and any of bit 02 or bits 02 to 07 is ON, an Other Parameter Error will occur and an end code of 110C hex will be returned.

**End code (response)**

Refer to 5-1-3 End Codes for information on end codes.

**Stored data type (response)**

When reading the data type in the Memory Cassette (parameter = 8000 hex), the following bits corresponding to the stored data will be turned ON. (More than one bit may be turned ON.)

Bit 07: Data memory initial values

Bit 06: Data memory

Bit 05: Program indices

Bit 04: Comments

Bit 03: Symbol table

Bit 02: Parameter area

Bit 01: Function block sources

Bit 00: User program

**5-3-44 FORCED SET/RESET: 23 01**

Force-sets (ON) or force-resets (OFF) bits/flags or releases force-set status. Bits/flags that are forced ON or OFF will remain ON or OFF and cannot be written to until the forced status is released.

**Execution Conditions**

| Access right at other device | UM read protection | DIP switch UM write protection | Network write protection |
|------------------------------|--------------------|--------------------------------|--------------------------|
| OK                           | OK                 | OK                             | No                       |

| RUN mode | MONITOR mode | PROGRAM mode |
|----------|--------------|--------------|
| No       | OK           | OK           |

**Note** "Forced status" means that the ON/OFF status of the bit/flag is forcibly retained and writing is prohibited.

**Command Format**

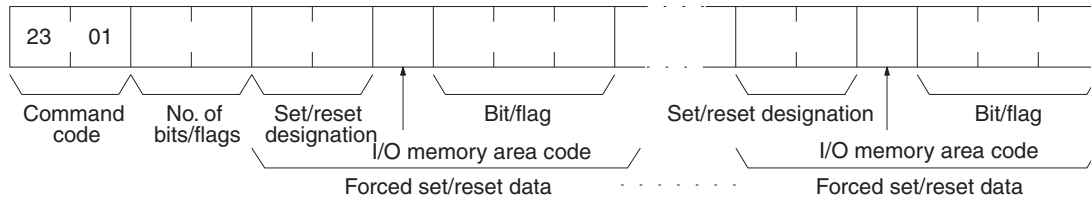

**Response Format**

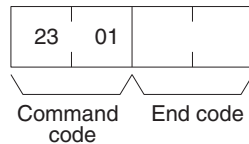

**Parameters**

**Number of bits/flags (command)**

Specify the number of bits/flags to be controlled.

**Set/reset designation (command)**

Specify the action to be taken for each bit/flag.

| Value (hex) | Name                         | Operation  |
|-------------|------------------------------|--|
| 0000        | Forced reset                 | Turns OFF (0) the bit/flag and places it in forced status. (See note.) |
| 0001        | Forced set                   | Turns ON (1) the bit/flag and places it in forced status.              |
| 8000        | Forced set/reset OFF release | Turns OFF (0) the bit/flag and releases the forced status.             |
| 8001        | Forced set/reset ON release  | Turns ON (1) the bit/flag and releases the forced status.              |
| FFFF        | Forced set/reset release     | Releases the forced status while retaining the ON/OFF status.          |

**I/O memory area code (command)**

Specify the I/O memory area of the bit or flag to be controlled.

**Bit/Flag (command)**

Specify the bit or flag to be controlled. The memory areas in which bits/flags can be controlled are given in the following table. Refer to 5-2-2 I/O Memory Address Designations for the specific addresses that can be used.

| Area             |     | Data type       | CS/CJ/CP/NSJ-series memory area code (hex) | CVM1/CV-series memory area code (hex) | Bytes per element |
|------------------|-----|-----------------|--|---------------------------------------|-------------------|
| CIO Area         | CIO | Bit             | 30   | 00                                    | 1                 |
| Work Area        | WR  |                 | 31   | ---                                   |                   |
| Holding Bit Area | HR  |                 | 32   | ---                                   |                   |
| Timer Area       | TIM | Completion Flag | 09   | 01                                    | 1                 |
| Counter Area     | CNT |                 |  |                                       |                   |

**End code (response)**

Refer to 5-1-3 End Codes for information on end codes.

**Comments**

To force set/reset multiple bits/flags, specify the “set/reset designation,” the “I/O memory area code,” and the “bit/flag” parameters for the number of bits/flags set in the “number of bits/flags” parameter.

**Note** If “forced set/reset OFF release (8000)” or “forced set/reset ON release (8001)” is exceeded for a bit/flag that does not have forced status, only the bit/flag’s ON/OFF status will be affected.

**5-3-45 FORCED SET/RESET CANCEL: 23 02**

Cancels all bits (flags) that have been forced ON or forced OFF.

**Execution Conditions**

|                                     |                           |                                       |                                 |
|-------------------------------------|---------------------------|---------------------------------------|---------------------------------|
| <b>Access right at other device</b> | <b>UM read protection</b> | <b>DIP switch UM write protection</b> | <b>Network write protection</b> |
| OK                                  | OK                        | OK                                    | No                              |

|                 |                     |                     |
|-----------------|---------------------|---------------------|
| <b>RUN mode</b> | <b>MONITOR mode</b> | <b>PROGRAM mode</b> |
| No              | OK                  | OK                  |

**Command Format**

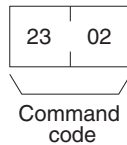

**Response Format**

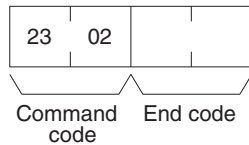

**End code (response)**

Refer to 5-1-3 End Codes for information on end codes.

**Comments**

The bits/flags in the following memory areas can be forced set or forced reset, and canceled.

| Memory area   | Data                   |
|---------------|------------------------|
| Relay areas   | Bit status             |
| Timer/Counter | Completion Flag status |

**5-3-46 CONVERT TO COMPOWAY/F COMMAND: 28 03**

When this command is sent to CS1-H CPU Units, CJ1-H CPU Units, CJ1M CPU Units with unit version 3.0 or later, serial port C on the Controller Section of an NSJ Controller, built-in serial ports of N-type CP1E CPU Units, serial port 1 or 2 on an Option Board of a CP-series CPU Unit, or a serial port on a Serial Communications Unit/Board (version 1.2 or later), the CPU Unit or Serial Communications Unit/Board removes the FINS header and sends the enclosed CompoWay/F command.

With this command, OMRON components connected to a PLC through CompoWay/F communications can be accessed from a PLC or PT by sending a FINS message containing a CompoWay/F command.

Execution Conditions

|                                     |                           |                                       |                                 |
|-------------------------------------|---------------------------|---------------------------------------|---------------------------------|
| <b>Access right at other device</b> | <b>UM read protection</b> | <b>DIP switch UM write protection</b> | <b>Network write protection</b> |
| OK                                  | OK                        | OK                                    | OK                              |

  

|                 |                     |                     |
|-----------------|---------------------|---------------------|
| <b>RUN mode</b> | <b>MONITOR mode</b> | <b>PROGRAM mode</b> |
| OK              | OK                  | OK                  |

Command Format

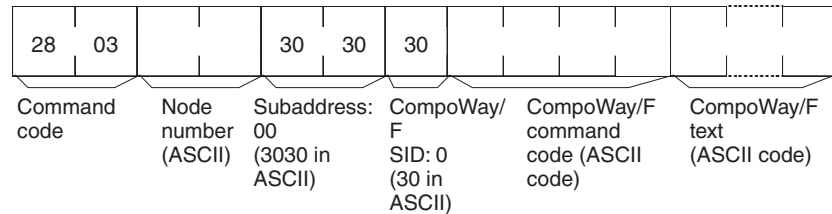

Response Format

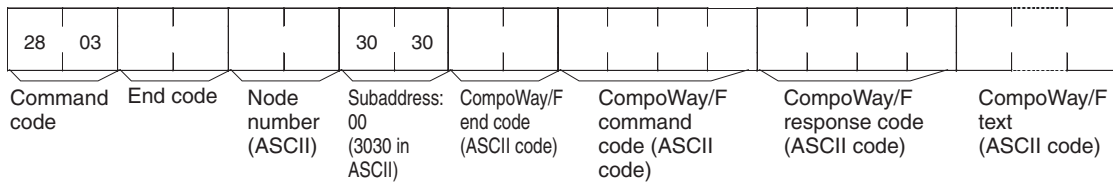

Parameters

**Command**

**Node Number**

This is the destination ID number (00 to 99 or XX) in the CompoWay/F system. The characters are specified in ASCII. When sending a broadcast transmission, set the node number to XX (two X's).

**Subaddress**

The subaddress is 00 for most models and the value is specified in ASCII as 3030 hex. For some models, other values must be set.

**CompoWay/F SID (Service ID)**

The Service ID is 0 for most models and the value is specified in ASCII as 30 hex. For some models, other values must be set.

**CompoWay/F Command Code**

This is the CompoWay/F command code. For details, refer to the command manual for the CompoWay/F Slave.

**CompoWay/F Text**

This is the data that follows the command code.

**Response**

**Node Number**

This is the destination ID number (00 to 99 or XX) in the CompoWay/F system. The characters are specified in ASCII. When a broadcast transmission is sent, the node number is set to XX (two X's).

**Subaddress**

The subaddress is 00 for most models and the value is specified in ASCII as 3030 hex. For some models, other values must be set.

**End Code (Response)**

The end code indicates the command frame's execution result. (The end code is not the same as the response code, which is described below.)

**CompoWay/F Command Code**

This is the CompoWay/F command code. For details, refer to the command manual for the CompoWay/F Slave.

**CompoWay/F Response Code**

The CompoWay/F response code indicates the results of the service requested by the command code. For details, refer to the command manual for the CompoWay/F Slave.

**CompoWay/F Text**

This is the data that follows the response code.

**Precautions**

- FINS Header (Destination Address)  
The following settings are required.
- Destination Network Address (DNA):
  - When a routing table is created to treat the serial communications path as a network, this is the network address associated with the Serial Communications Unit or Board's serial port by the routing table
  - When a routing table is not created to treat the serial communications path as a network, this is the actual network address used to specify the destination PLC.
- Destination Node Address (DA1):
  - When a routing table is created to treat the serial communications path as a network, set 00 hex for communications within the local PLC or the "Host Link unit number + 1" for serial → serial → serial conversion.
  - When a routing table is not created to treat the serial communications path as a network, this is the actual node address used to specify the destination PLC (the "Host Link unit number + 1" for serial → serial → serial conversion).
- Destination Unit Address (DA2):  
This is the serial port's unit address.  
Settings for a Serial Communications Board or Unit:
  - Unit addresses for serial port 1:

| Unit number | 0   | 1   | 2   | 3   | 4   | 5   | 6   | 7   | 8   | 9   | A   | B   | C   | D   | E   | F   | Board |
|-------------|-----|-----|-----|-----|-----|-----|-----|-----|-----|-----|-----|-----|-----|-----|-----|-----|-------|
| Hexadecimal | 80  | 84  | 88  | 8C  | 90  | 94  | 98  | 9C  | A0  | A4  | A8  | AC  | B0  | B4  | B8  | BC  | E4    |
| Decimal     | 128 | 132 | 136 | 140 | 144 | 148 | 152 | 156 | 160 | 164 | 168 | 172 | 176 | 180 | 184 | 188 | 228   |

- Unit addresses for serial port 2:

| Unit number | 0   | 1   | 2   | 3   | 4   | 5   | 6   | 7   | 8   | 9   | A   | B   | C   | D   | E   | F   | Board |
|-------------|-----|-----|-----|-----|-----|-----|-----|-----|-----|-----|-----|-----|-----|-----|-----|-----|-------|
| Hexadecimal | 81  | 85  | 89  | 8D  | 91  | 95  | 99  | 9D  | A1  | A5  | A9  | AD  | B1  | B5  | B9  | BD  | E5    |
| Decimal     | 129 | 133 | 137 | 141 | 145 | 149 | 153 | 157 | 161 | 165 | 169 | 173 | 177 | 181 | 185 | 189 | 229   |

- Sending CompoWay/F Commands with the CMND Instruction
  - Set FINS command code 2803 hex (CONVERT TO COMPOWAY/F) in S.
  - Set the following parameters starting at S+1 in ASCII with the leftmost byte first: CompoWay/F node number (2-byte ASCII), subaddress (2-byte ASCII), SID (2-byte ASCII), CompoWay/F command MRC (2-byte ASCII), CompoWay/F command SRC (2-byte ASCII), and text (ASCII, 2 × n bytes)

Note For CompoWay/F, set SID 0 (1-byte ASCII: 30 hex) in the leftmost byte of S+3 and the most significant digit of the CompoWay/F command code's MRC (1-byte ASCII) in the rightmost byte of S+3. Set the least significant digit of the CompoWay/F command code's MRC (1-byte ASCII) in the leftmost byte of S+4 and the most significant digit of the CompoWay/F command code's SRC (1-byte ASCII) in the rightmost byte of S+4. Be sure to set the remaining data with this 1-byte offset as well.

**5-3-47 CONVERT TO MODBUS-RTU COMMAND: 28 04**

When this command is sent to serial port 1 or 2 on an Option Board of a CP-series CPU Unit, or a serial port on a Serial Communications Unit/Board (version 1.2 or later), the CPU Unit or Serial Communications Unit/Board removes the FINS header and sends the enclosed Modbus-RTU command.

With this command, OMRON components connected to a PLC through Modbus-RTU communications can be accessed from a PLC or PT by sending a FINS message containing a Modbus-RTU command.

**Execution Conditions**

|                                     |                           |                                       |                                 |
|-------------------------------------|---------------------------|---------------------------------------|---------------------------------|
| <b>Access right at other device</b> | <b>UM read protection</b> | <b>DIP switch UM write protection</b> | <b>Network write protection</b> |
| OK                                  | OK                        | OK                                    | OK                              |

  

|                 |                     |                     |
|-----------------|---------------------|---------------------|
| <b>RUN mode</b> | <b>MONITOR mode</b> | <b>PROGRAM mode</b> |
| OK              | OK                  | OK                  |

**Command Format**

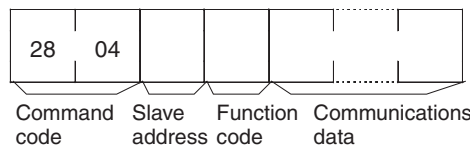

**Response Format**

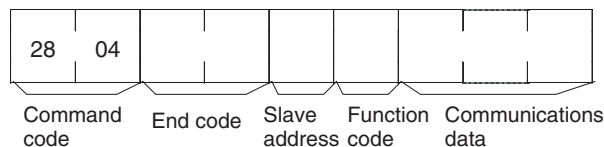

**Parameters**

**Command**

**Slave Address**

Specify the Modbus-RTU device address. Set the address in hexadecimal between 01 and F7 hex (1 to 247 decimal).

**Function Code**

Specify the function code of the Modbus-RTU command. Set the address in hexadecimal between 01 and FF hex (1 to 255 decimal).

**Communications Data**

Specify the required parameters associated with the function code. The amount of communications data varies. (In some cases, there is no communications data.)

**Response**

The response is the same as the command except that it contains an end code.



**Precautions**

- FINS Header (Destination Address) Contents  
The following settings are required.
- Destination Network Address (DNA):
  - When a routing table is created to treat the serial communications path as a network, this is the network address associated with the Serial Communications Unit or Board's serial port by the routing table
  - When a routing table is not created to treat the serial communications path as a network, this is the actual network address used to specify the destination PLC.
- Destination Node Address (DA1):
  - When a routing table is created to treat the serial communications path as a network, set 00 hex for communications within the local PLC or the "Host Link unit number + 1" for serial → serial → serial conversion.
  - When a routing table is not created to treat the serial communications path as a network, this is the actual node address used to specify the destination PLC (the "Host Link unit number + 1" for serial → serial → serial conversion).
- Destination Unit Address (DA2):  
This is the serial port's unit address.  
Settings for a CP1H CPU Unit and CP1L CPU Unit

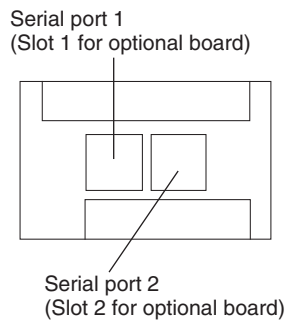

| CPU Unit port | Unit address of port |
|---------------|----------------------|
| Serial port 1 | FD hex (253 decimal) |
| Serial port 2 | FC hex (252 decimal) |

Settings for a Serial Communications Board or Unit:

- Unit addresses for serial port 1:

| Unit number | 0   | 1   | 2   | 3   | 4   | 5   | 6   | 7   | 8   | 9   | A   | B   | C   | D   | E   | F   | Board |
|-------------|-----|-----|-----|-----|-----|-----|-----|-----|-----|-----|-----|-----|-----|-----|-----|-----|-------|
| Hexadecimal | 80  | 84  | 88  | 8C  | 90  | 94  | 98  | 9C  | A0  | A4  | A8  | AC  | B0  | B4  | B8  | BC  | E4    |
| Decimal     | 128 | 132 | 136 | 140 | 144 | 148 | 152 | 156 | 160 | 164 | 168 | 172 | 176 | 180 | 184 | 188 | 228   |

- Unit addresses for serial port 2:

| Unit number | 0   | 1   | 2   | 3   | 4   | 5   | 6   | 7   | 8   | 9   | A   | B   | C   | D   | E   | F   | Board |
|-------------|-----|-----|-----|-----|-----|-----|-----|-----|-----|-----|-----|-----|-----|-----|-----|-----|-------|
| Hexadecimal | 81  | 85  | 89  | 8D  | 91  | 95  | 99  | 9D  | A1  | A5  | A9  | AD  | B1  | B5  | B9  | BD  | E5    |
| Decimal     | 129 | 133 | 137 | 141 | 145 | 149 | 153 | 157 | 161 | 165 | 169 | 173 | 177 | 181 | 185 | 189 | 229   |

- Sending Modbus-RTU Commands with the CMND Instruction
  - Set FINS command code 2804 hex (CONVERT TO MODBUS-RTU COMMAND) in S.
  - Set the following parameters starting at S+1 with the leftmost byte first (see note): Slave address (1 byte), Function code (1 byte), and the communications data (n bytes).

Note For Modbus-RTU, set the Modbus-RTU Slave address (1 byte) in the leftmost byte of S+1 and the function code (1 byte) in the rightmost byte of S+1.

### 5-3-48 CONVERT TO MODBUS-ASCII COMMAND: 28 05

When this command is sent to a serial port on a Serial Communications Unit or Board (Ver. 1.2 or later), the Serial Communications Unit/Board removes the FINS header and sends the enclosed Modbus-ASCII command.

With this command, OMRON components connected to a PLC through Modbus-ASCII communications can be accessed from a PLC or PT by sending a FINS message containing a Modbus-ASCII command.

#### Execution Conditions

|                                     |                           |                                       |                                 |
|-------------------------------------|---------------------------|---------------------------------------|---------------------------------|
| <b>Access right at other device</b> | <b>UM read protection</b> | <b>DIP switch UM write protection</b> | <b>Network write protection</b> |
| OK                                  | OK                        | OK                                    | OK                              |

|                 |                     |                     |
|-----------------|---------------------|---------------------|
| <b>RUN mode</b> | <b>MONITOR mode</b> | <b>PROGRAM mode</b> |
| OK              | OK                  | OK                  |

#### Command Format

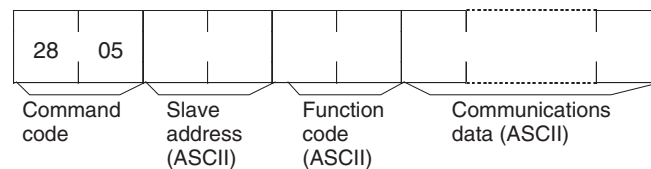

#### Response Format

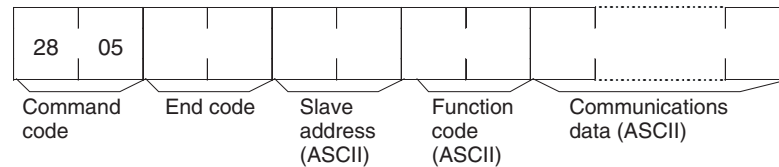

#### Parameters

##### Command

##### **Slave Address**

Specify the Modbus-ASCII device address. Set the address in ASCII between 01 and F7 hex (3031 to 4637 ASCII), which is 1 to 247 in decimal.

##### **Function Code**

Specify the function code of the Modbus-ASCII command. Set the address in ASCII between 01 and FF hex (3031 to 4646 ASCII), which is 1 to 255 in decimal.

##### **Communications Data**

Specify the required parameters (in ASCII) associated with the function code. The amount of communications data varies. (In some cases, there is no communications data.)

##### Response

The response is the same as the command except that it contains an end code.

**Precautions**

- FINS Header (Destination Address) Contents  
The following settings are required.
- Destination Network Address (DNA):
  - When a routing table is created to treat the serial communications path as a network, this is the network address associated with the Serial Communications Unit or Board's serial port by the routing table
  - When a routing table is not created to treat the serial communications path as a network, this is the actual network address used to specify the destination PLC.
- Destination Node Address (DA1):
  - When a routing table is created to treat the serial communications path as a network, set 00 hex for communications within the local PLC or the "Host Link unit number + 1" for serial → serial → serial conversion.
  - When a routing table is not created to treat the serial communications path as a network, this is the actual node address used to specify the destination PLC (the "Host Link unit number + 1" for serial → serial → serial conversion).
- Destination Unite Address (DA2):  
This is the serial ports unit address.
  - Unit addresses for serial port 1:

| Unit number | 0   | 1   | 2   | 3   | 4   | 5   | 6   | 7   | 8   | 9   | A   | B   | C   | D   | E   | F   | Bo<br>ard |
|-------------|-----|-----|-----|-----|-----|-----|-----|-----|-----|-----|-----|-----|-----|-----|-----|-----|-----------|
| Hexadecimal | 80  | 84  | 88  | 8C  | 90  | 94  | 98  | 9C  | A0  | A4  | A8  | AC  | B0  | B4  | B8  | BC  | E4        |
| Decimal     | 128 | 132 | 136 | 140 | 144 | 148 | 152 | 156 | 160 | 164 | 168 | 172 | 176 | 180 | 184 | 188 | 228       |

- Unit addresses for serial port 2:

| Unit number | 0   | 1   | 2   | 3   | 4   | 5   | 6   | 7   | 8   | 9   | A   | B   | C   | D   | E   | F   | Bo<br>ard |
|-------------|-----|-----|-----|-----|-----|-----|-----|-----|-----|-----|-----|-----|-----|-----|-----|-----|-----------|
| Hexadecimal | 81  | 85  | 89  | 8D  | 91  | 95  | 99  | 9D  | A1  | A5  | A9  | AD  | B1  | B5  | B9  | BD  | E5        |
| Decimal     | 129 | 133 | 137 | 141 | 145 | 149 | 153 | 157 | 161 | 165 | 169 | 173 | 177 | 181 | 185 | 189 | 229       |

- Sending Modbus-ASCII Commands with the CMND Instruction
  - Set FINS command code 2805 hex (CONVERT TO MODBUS-ASCII COMMAND) in S.
  - Set the following parameters in ASCII starting at S+1 with the leftmost byte first: Slave address (2-byte ASCII), Function code (2-byte ASCII), and the communications data (ASCII, 2 × n bytes).

Note For Modbus-RTU, set the Modbus-RTU Slave address (1 byte) in the leftmost byte of S+1 and the function code (1 byte) in the rightmost byte of S+1.



# Index

## A-B

ABORT (XZ), 147  
access right  
  acquiring, 5, 150, 153, 202, 204  
  at another device, 171  
  releasing, 5, 150, 153, 206  
accessing I/O memory, 4  
accessing program area, 3, 4, 101  
accessing time data, 4, 150, 153  
AR AREA READ (RJ), 112  
AR AREA WRITE (WJ), 119  
ASCII data, 32  
backup  
  precautions, xviii  
Battery Error Flag, xviii  
bits  
  controlling, 229, 231

## C

CIO Area  
  reading, 177  
CIO AREA READ (RR), 106  
CIO AREA WRITE (WR), 114  
clock  
  reading, 197  
  setting, 198  
CMND(490), 31, 54, 59, 60, 170  
  setting example, 43  
C-mode commands, 2  
  command formats, 9  
  details, 99–148  
  execution conditions, 105  
  force conditions, 102  
  from host computer, 14  
  list of, 2, 100  
  overview, 7–25  
  partitioned, 10  
  partitioned responses, 11  
  response formats, 9  
command formats  
  for C-mode commands, 9  
commands  
  C-mode, 2  
  from host computer, 14  
  overview, 7–25  
  communications, 2  
    addressed to CS/CJ-series PLCs, 2  
  FINS, 2, 4, 27–66, 152  
  parameters, 163  
  partitioned, 10

  commands for CV series PLCs  
    ACCESS RIGHT RELEASE, 206  
  Communications Port Enabled Flags, 59  
  Communications Port Error Flags, 59  
  counters  
    reading Completion Flag status, 177  
CPU Unit  
  status, 3, 101  
cycle time  
  reading, 196

## D

DA1, 33  
DA2, 34  
debugging, 5, 151, 154  
destination node number, 33  
destination unit address, 34  
DIP switch UM protection, 171  
directories  
  creating/deleting, 227  
DM Area  
  reading, 171, 177  
  writing, 174, 175  
DM AREA READ (RD), 111  
DM AREA WRITE (WD), 118

## E

EM AREA READ (RE), 113  
EM AREA WRITE (WE), 120  
end codes, 103–104, 155–164  
environment  
  precautions, xviii  
error log, 5, 150, 153  
ERROR READ (MF), 135  
error response format  
  for C-mode commands, 10  
errors  
  clearing, 207, 210  
  reading, 201, 208  
execution conditions  
  for C-mode commands, 105  
  for FINS commands, 171

## F

FAL/FALS messages, 201  
fatal error data, 195  
FCS calculations, 13

file memory, 5, 151, 154

files

- changing file names, 220
- comparing, 221, 223, 225
- copying, 219
- deleting, 218
- file name configuration, 168
- reading, 212, 215
- transferring, 221, 223, 225
- writing, 216

FINS commands, 2, 4, 150, 151, 152, 170–227

- addresses, 36
- command format, 35, 170
- command frame, 32
- command settings, 42
- detailed descriptions, 149
- execution conditions, 171
- explanation, 28
- list of, 4, 150
- overview, 27–66
- response format, 35, 170
- response frame, 32
- restrictions, 153–154
- settings for sending, 35
- timing, 60
- to CS/CJ-Series CPU Units, 29
- types of, 29
- with Host Link protocol, 44

flags

- for network communications, 59

force conditions

- for C-mode commands, 102

FORCED RESET (KR), 138

FORCED SET (KS), 137

forced set/reset, 3, 101

FORCED SET/RESET CANCEL (KC), 140

## H

Host Link communications, 32, 171

- command frame, 32
- response frame, 32

Host Link FCS, 45

Host Link header, 45

Host Link terminator, 45

Host Link Units

- for CS/CJ-series PLCs, 8

HR AREA READ (RH), 108

HR AREA WRITE (WH), 116

## I-L

I/O memory

- accessing, 4, 150, 153
- addresses, 163–164
- reading, 2, 4, 100, 101
- registering, 4, 101
- table of address designations, 165–171
- writing, 3, 100

I/O table

- creating, 4, 101

I/O TABLE GENERATE (MI), 144

INITIALIZE (\*\*), 148

installation

- precautions, xviii

LR AREA READ (RL), 107

LR AREA WRITE (WL), 115

## M-N

machine configuration

- reading, 4, 150, 153

memory areas

- accessing I/O, 4
- comparing/transferring, 221
- reading, 171, 177
- transferring data, 180
- writing, 174, 175

messages, 195

- clearing, 200
- displaying, 5, 150, 153
- reading, 199, 201

model code, 3, 101

model numbers

- reading model numbers of Units, 193
- reading PLC model number, 190

MULTIPLE FORCED SET/RESET (FK), 139

non-fatal error data, 195

## O

online edit

- precautions, xvii

operating environment

- precautions, xviii

operating mode

- at startup, xx
- changing, 4, 150, 153

## **P**

### Parameter Areas

- accessing, 4, 150, 153
- clearing, 184
- comparing/transferring, 223
- reading, 181
- writing, 182

partitioned commands, 10

partitioned responses, 11

### PLC

- changing to RUN mode, 189
- reading controller data, 190

PLC model code reading, 3, 101

PLC MODEL READ (MM), 141

### precautions

- application, xix
- general, xv
- operating environment, xviii
- safety, xvi

### program

- clearing, 187
- comparing/transferring, 225
- reading, 185
- writing to program area words, 186

### program area

- accessing, 3, 4, 101, 150, 153

PROGRAM READ (RP), 142

PROGRAM WRITE (WP), 143

## **R**

READ I/O MEMORY (QQIR), 146

RECV(098), 59, 60

REGISTER I/O MEMORY (QQMR), 145

remote I/O systems, 192

response codes, 103–105, 155–??

### response formats

- for C-mode commands, 9

### responses

- partitioned, 11

## **S**

SA1, 34

SA2, 34

safety precautions, xvi

SEND(090), 59, 60

service ID, 34

SID, 34

SNA, 34

source network address, 34

source node number, 34

source unit address, 34

startup mode, xx

### status

- reading, 4, 150, 153

STATUS CHANGE (SC), 134

STATUS READ (MS), 133

subdirectories, 227

## **T**

TEST (TS), 142

testing, 3, 101

### time data

- accessing, 4, 150, 153

TIMER/COUNTER PV READ (RC), 109

TIMER/COUNTER PV WRITE (WC), 117

TIMER/COUNTER STATUS READ (RG), 110

TIMER/COUNTER SV CHANGE 1 (W#), 127

TIMER/COUNTER SV CHANGE 2 (W\$), 128

TIMER/COUNTER SV CHANGE 3 (W%), 130

TIMER/COUNTER SV READ 1 (R#), 121

TIMER/COUNTER SV READ 2 (R\$), 122

TIMER/COUNTER SV READ 3 (R%), 124

### timers

- reading Completion Flag status, 177

## **U-V**

UM read protection, 171

undefined command (IC), 148

volume labels, 168





## Revision History

A manual revision code appears as a suffix to the catalog number on the front cover of the manual.

Cat. No. W342-E1-18

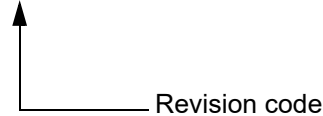

The following table outlines the changes made to the manual during each revision. Page numbers refer to the previous version.

| Revision code | Date           | Revised content   |
|---------------|----------------|---|
| 01            | February 1999  | Original production   |
| 02            | September 1999 | <b>Page 18:</b> Catalog number corrected for the CQM1 PC.<br><b>Pages 31, 117:</b> The S+2 beginning read address for the first command word corrected for CMND(490).   |
| 03            | April 2000     | <b>Page 26:</b> Internal communications setting added for DA1 and SA1.<br><b>Page 28:</b> Values for node address changed in table.<br><b>Page 37:</b> Last two sentences removed from SA2 description.   |
| 04            | May 2001       | Changes were made throughout the manual to include information for new products (CJ1G-CPU44/45 and CJ1W-SCU41). In addition, the following changes were made.<br><b>Page 15:</b> Information on words per frame and the response format for MS commands added.<br><b>Page 18:</b> Note added after first table.<br><b>Page 45:</b> Information on formats for commands to and responses from the host computer added.<br><b>Page 57:</b> Information on end code 23 changed.<br><b>Page 60:</b> Description of "UM Area, Read-protected" changed.<br><b>Page 63:</b> Information added under "Limitations."<br><b>Page 85:</b> Text under second format diagram changed.<br><b>Page 88:</b> Some error names in the response format diagram changed.<br><b>Page 118:</b> Information on volume labels and file names changed.<br><b>Page 125:</b> Information under "Comments" changed.<br><b>Page 131:</b> Command format diagram changed.<br><b>Pages 154, 157, 158, 160, 161, 163, 164, 166, 167:</b> Description of directory length changed.<br><b>Pages 155, 157, 158, 160, 161, 163, 165, 166, 167:</b> Description of absolute directory path changed.<br><b>Page 156:</b> Information on attribute, and date and time added. "12 bytes" removed from response format diagram.<br><b>Pages 158, 160:</b> Reference added under "file name."<br><b>Page 160:</b> Second paragraph under "Comments" removed.<br><b>Page 161:</b> Sentence added to first paragraph. Reference added under "old and new file names."<br><b>Page 167:</b> Changes made to information under "directory name." |
| 05            | October 2001   | Changes were made throughout the manual to include information for new products (CS1G/H-CPU□□H and CJ1G/H-CPU□□H). In addition, the following changes were made.<br><b>Page ix:</b> Table updated.<br><b>Pages 16, 21:</b> New models added.<br><b>Page 49:</b> Response Wait Time description corrected.<br><b>Page 115:</b> "06: Program missing" corrected.<br><b>Page 117:</b> "02: Parity of checksum" corrected.<br><b>Page 118:</b> "SFC" removed from "01: No access right."<br><b>Page 120:</b> Two illustrations added and top illustration reworded.<br><b>Page 125:</b> "Hex" added.<br><b>Page 128:</b> Notes added.<br><b>Page 132:</b> Sentence added after table.<br><b>Page 135:</b> Addition made to bottom of page.<br><b>Page 137:</b> Sentence added toward end of 5-3-8.<br><b>Pages 139 and 140:</b> Number corrected at end of 5-3-10 and 5-3-11.<br><b>Page 140:</b> Number of bytes description corrected.<br><b>Page 141:</b> "All clear" removed twice and "execution" changed to "cyclic" twice.<br><b>Page 143:</b> Addition made to command format and sentence added to end of 5-3-14.<br><b>Page 144:</b> End of CPU Unit model and version description corrected.<br><b>Page 145:</b> "Always 23" added to table.<br><b>Page 151:</b> Addition made to response format.<br><b>Page 161:</b> Last two lines removed.<br><b>Page 162:</b> End of 5-3-28 corrected.<br><b>Page 178:</b> Note moved.<br><b>Page 179:</b> Table column removed.  |

## Revision History

| Revision code | Date          | Revised content  |
|---------------|---------------|--|
| 06            | August 2002   | <p>"PC" was changed to "PLC" throughout the manual in the sense of "Programmable Controller."</p> <p>CJ1M CPU Units and new versions of Serial Communications Units/Boards were added.</p> <p><b>Page 28:</b> Description of GCT changed.</p> <p><b>Page 35:</b> Note added.</p> <p><b>Page 125:</b> Information added following table.</p>  |
| 07            | May 2003      | <p>Changes were made throughout the manual to include information for new products (CS1D-CPU□□□H and CJ1G/H-CPU□□EV1).</p> <p><b>Page ix:</b> Table updated to correct catalog numbers and add new catalogs.</p> <p><b>Page xiii:</b> A caution added regarding back up information.</p> <p><b>Page xiv:</b> Corrected "CJ Series CPU Units" to "CJ1, CJI-H, CJ1M, or CS1D CPU Units."</p> <p><b>Page xv:</b> A caution added regarding operating differences between CS1 and CJ1, CJI-H, CJ1M, or CS1D CPU Units when using factory settings.</p> <p><b>Page 22:</b> Table corrected to include new CS/CJ-series models.</p> <p><b>Page 30</b> "00 0A Hex" for first read address in graphic corrected to "0A 00 Hex."</p> <p><b>Page 55:</b> Order of steps 9 and 10 corrected in graphic.</p> <p><b>Page 93:</b> "Bit 1" corrected to "Bit 0" in graphic of response format.</p> <p><b>Page 113:</b> Note on flags in end code added.</p> <p><b>Page 119, 120:</b> Information on flags in end codes and handling errors changed.</p> <p><b>Page 132:</b> "00" corrected to "---" in CV mode memory area code column for CIO Area and AR Area.</p> <p><b>Page 150:</b> Information on operating status parameters updated for new models.</p> <p><b>Page 151:</b> "Reserved for system" changed to "1: Duplex error" in bit 14 of non-fatal error data response.</p> <p><b>Page 163:</b> Table of error codes updated for new models.</p> |
| 08            | December 2003 | <p><b>Pages xi to xvii:</b> PLP information updated.</p> <p><b>Front of manual:</b> Information added on unit versions.</p> <p><b>Pages 4, 5, 110, and 111:</b> Note and references to it added and 21 40 and 21 41 added.</p> <p><b>Pages 24 and 28:</b> Note added.</p> <p><b>Page 45:</b> Information on destination unit address changed.</p> <p><b>Page 55:</b> Addresses corrected in program</p> <p><b>Page 110:</b></p> <p><b>Pages 111 to 113:</b> Column added and 21 40 and 21 41 added.</p> <p><b>Pages 146 and 167:</b> "Version" changed to "internal system version."</p> <p><b>Page 163:</b> "FFFF" added to table.</p> <p><b>Page 166:</b> Sections added on 21 40 and 21 41.</p>   |
| 09            | August 2004   | <p>"CompoBus/D" was changed to "DeviceNet" throughout the manual.</p> <p><b>Pages 8, 38, and 111:</b> Notes added.</p> <p><b>Page 15:</b> Section 2-4 replaced.</p> <p><b>Page 24:</b> Note changed.</p> <p><b>Page 28:</b> Description of ICDV and RSV changed.</p> <p><b>Pages 28, 29, 41, 49, and 50:</b> Information on GCT changed.</p> <p><b>Pages 28, 29, 31, 40, 45, 46, and 48:</b> Information added on new Ethernet Units and other settings changed.</p> <p><b>Page 33:</b> Information on unit addresses added.</p> <p><b>Page 34:</b> Graphic changed.</p> <p><b>Page 35:</b> Values for gateway count changed.</p> <p><b>Pages 39, 41, 44, 45, 47, 49, and 50:</b> Values of GCT/RSV changed.</p> <p><b>Page 41:</b> Description of RSV changed.</p> <p><b>Page 58:</b> Section added.</p> <p><b>Page 70:</b> Status definitions added to graphic.</p> <p><b>Pages 111 and 113:</b> Commands added to table.</p> <p><b>Page 185:</b> Commands 28 03, 28 04, and 28 05 added.</p>  |
| 10            | January 2006  | <p><b>Page v:</b> Information on general precautions notation added.</p> <p><b>Page xxiii:</b> Information on liability and warranty added.</p>  |
| 11            | October 2006  | <p>Corrections and additions were made throughout the manual to include the following Unit: CP-series PLCs, CJ1G-CPU□□□P, X-, XA-, and Y-type CP1H CPU Units, NSJ Controllers, and version 1 of the Serial Communications Units.</p> <p>Other changes and corrections are as follows:</p> <p><b>Pages x to xvi:</b> Changed and expanded.</p> <p><b>Pages xix and xx:</b> Models and manuals added.</p> <p><b>Page xxxiv:</b> Added precaution on dispose of the product and batteries.</p> <p><b>Pages 5, 149, 152, and 223:</b> Added MEMORY CASSETTE TRANSFER command.</p> <p><b>Page 15:</b> Replaced most of page.</p> <p><b>Page 19:</b> Corrected last two rows of table.</p> <p><b>Page 41:</b> Changed last part of note 1.</p> <p><b>Pages 72 and 78:</b> Changed "PC" to "PLC" (multiple places).</p> <p><b>Pages 84, 227, 229, and 231:</b> Added <i>Board</i> column.</p> <p><b>Page 171:</b> Changed <i>Comments</i> section.</p> <p><b>Page 191:</b> Changed description of bits 00 and 01.</p>   |

---

## **Revision History**

---

| <b>Revision code</b> | <b>Date</b>    | <b>Revised content</b>  |
|----------------------|----------------|---|
| 12                   | September 2008 | Corrections and additions were made throughout the manual to include the following Unit: CJ2H-CPU□□-EIP, and CP1L-M/L□□□□-□ |
| 13                   | December 2008  | Added the CJ-series CJ2 CPU Units (CJ2H-CPU□□).   |
| 14                   | July 2009      | Added the CP-series CP1E CPU Units.<br>Added the Ethernet option board (CP1W-CIF41).  |
| 15                   | February 2010  | Added the CJ-series CJ2M CPU Units.   |
| 16                   | February 2017  | Added descriptions and corrected mistakes.  |
| 17                   | December 2018  | Added the following CPU Units<br>a. CS1D-CPU□□HA<br>b. CS1D-CPU□□SA<br>Added descriptions and corrected mistakes.           |
| 18                   | July 2023      | Added descriptions.   |

---

## *Revision History*

---



## **OMRON Corporation Industrial Automation Company**

**Kyoto, JAPAN**

**Contact : [www.ia.omron.com](http://www.ia.omron.com)**

### ***Regional Headquarters***

#### **OMRON EUROPE B.V.**

Wegalaan 67-69, 2132 JD Hoofddorp  
The Netherlands

Tel: (31) 2356-81-300 Fax: (31) 2356-81-388

#### **OMRON ASIA PACIFIC PTE. LTD.**

438B Alexandra Road, #08-01/02 Alexandra  
Technopark, Singapore 119968

Tel: (65) 6835-3011 Fax: (65) 6835-2711

#### **OMRON ELECTRONICS LLC**

2895 Greenspoint Parkway, Suite 200  
Hoffman Estates, IL 60169 U.S.A.

Tel: (1) 847-843-7900 Fax: (1) 847-843-7787

#### **OMRON (CHINA) CO., LTD.**

Room 2211, Bank of China Tower,  
200 Yin Cheng Zhong Road,  
PuDong New Area, Shanghai, 200120, China

Tel: (86) 21-5037-2222 Fax: (86) 21-5037-2200

**Authorized Distributor:**

©OMRON Corporation 1999 - 2023 All Rights Reserved.  
In the interest of product improvement,  
specifications are subject to change without notice.

**Cat. No. W342-E1-18** 0723